



User's Manual



**MX2-4x4-HDMI20-CA, MX2-8x4-HDMI20-CA,
MX2-8x8-HDMI20-L, -CA, -Audio -Audio-L; MX2-8x8-DH-4DPi-A; MX2-8x8-DH-4DPio-A,
MX2-8x8-DH-8DPi-A; MX2-8x8-DH-8DPio-A; MX2-16x8-HDMI20-Audio-R,
MX2-16x16-HDMI20, -R, -Audio, -Audio-R;
MX2-16x16-DH-8DPi-A-R; MX2-16x16-DH-16DPi-R;
MX2-24x24-HDMI20, -R, -Audio, -Audio-R; MX2-24x24-DH-12DPi-R; -A-R
MX2-24x24-DH-24DPio-A-R ; MX2-32x32-HDMI20-A-R; MX2-32x32-DH-16DPi-A-R;
MX2-48x48-HDMI20-A-R; MX2-48x48-DH-48DPi-A-R, MX2-48x48-DH-24DPio-A-R**

Multimedia Matrix Switcher

Important Safety Instructions

Class I Apparatus Construction.

This equipment must be used with a mains power system with a protective earth connection. The third (earth) pin is a safety feature, do not bypass or disable it. The equipment should be operated only from the power source indicated on the product.

To disconnect the equipment safely from power, remove the power cord from the rear of the equipment or from the power source. The MAINS plug is used as the disconnect device, the disconnect device shall remain readily operable.

There are no user-serviceable parts inside of the unit. Removal of the cover will expose dangerous voltages. To avoid personal injury, do not remove the cover. Do not operate the unit without the cover installed.

The appliance must be safely connected to multimedia systems. Follow instructions described in this manual.

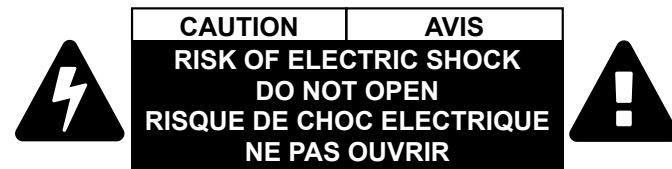

Replacing the AC fuse

Unplug the AC power cord from the device. Locate the AC fuse on the rear panel. Replace only the AC fuse as indicated on the rear panel. Connect the power cord to the switcher and to the AC power source. Make sure the switcher is working properly.

Ventilation

For the correct ventilation and to avoid overheating, ensure enough free space around the appliance. Do not cover the appliance, leave the ventilation holes free and never block or bypass the ventilators (if there are any).

WARNING

To prevent injury, the apparatus is recommended to be securely attached to the floor/wall or mounted in accordance with the installation instructions. The apparatus shall not be exposed to dripping or splashing, and no objects filled with liquids, such as vases, shall be placed on the apparatus. No naked flame sources, such as lit candles, should be placed on the apparatus.

Waste Electrical & Electronic Equipment WEEE

This marking shown on the product or its literature indicates that it should not be disposed with other household wastes at the end of its working life. To prevent possible harm to the environment or human health from uncontrolled waste disposal, please separate this from other types of wastes and recycle it responsibly to promote the sustainable reuse of material resources. Household users should contact either the retailer where they purchased this product, or their local government office for details of where and how they can take this item for environmentally safe recycling. Business users should contact their supplier and check the terms and conditions of the purchase contract. This product should not be mixed with other commercial wastes for disposal.



Common Safety Symbols

Symbol	Description
	Alternating current
	Protective conductor terminal
	Caution, possibility of electric shock
	Caution

Symbol Legend

The following symbols and markings are used in the document:

WARNING! Safety-related information that is highly recommended to read and keep in every case!

ATTENTION! Useful information for performing a successful procedure; it is recommended to read.

DIFFERENCE: Feature or function that is available with a specific firmware/hardware version or product variant.

INFO: A notice, which may contain additional information. Procedure can be successful without reading it.

DEFINITION: The short description of a feature or a function.

TIPS AND TRICKS: Ideas that you may have not known yet, but can be useful.

Navigation Buttons

 Go back to the previous page. If you clicked on a link previously, you can go back to the source page by pressing the button.

 Navigate to the Table of Contents.

 Step back one page.

 Step forward to the next page.

Document Information

All presented functions refer to the indicated products. The descriptions have been made while testing these functions in accordance with the indicated Hardware/Firmware/Software environment:

Item	Version
Lightware Device Controller (LDC) software	2.11.0b3
Lightware Device Updater V2 (LDU2) software	2.30.0b2
Firmware package	1.11.0

Document revision: **v2.24**

Release date: **27-08-2024**

Editor: Tamas Forgacs

About Printing

Lightware Visual Engineering supports green technologies and eco-friendly mentality. Thus, this document is primarily made for digital use. If you need to print out a few pages for any reason, follow the recommended printing settings:

- Page size: A4
- Output size: Fit to page or Match page size
- Orientation: Landscape

TIPS AND TRICKS: Thanks to the size of the original page, the border around the content (grey on the second picture below) makes it possible to organize the pages better. After punching holes in the printed pages, they can easily be placed into a ring folder.

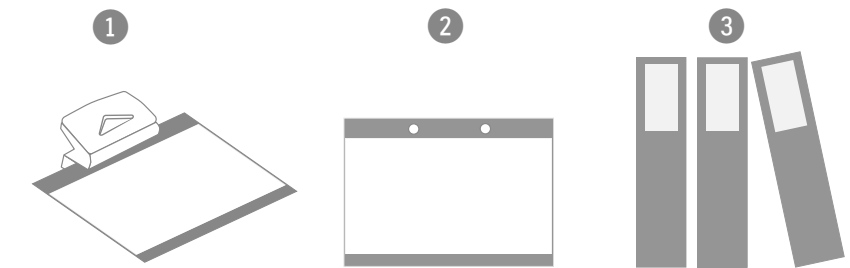

Hashtag (#) Keywords in the Document

This user's manual contains keywords with hashtags (#) to help you find the relevant information as quick as possible.

The format of the keywords is the following:

#<keyword>

The usage of the keywords: use the **Search** function (Ctrl+F / Cmd+F) of your PDF reader application, type the # (hashtag) character and the wished keyword.

The **#new** special keyword indicates a new feature/function that has just appeared in the latest firmware or software version.

Example

#dhcp

This keyword is placed at the DHCP setting command in the LW3 Programmer's reference section.

Table of Contents

1. INTRODUCTION	7	5.3. DISPLAYPORT VIDEO OPTIONS	37	8.3. ROUTER STATUS COMMANDS	70
1.1. DESCRIPTION.....	8	5.3.1. Color Conversion	37	8.3.1. List of All Available LW2 Commands	70
1.2. BOX CONTENTS	9	5.3.2. Limitations of the DisplayPort Video Options	38	8.3.2. Viewing Product Type.....	70
1.3. FEATURES FOR ALL MODELS	11	5.4. ANALOG AUDIO OPTIONS	38	8.3.3. Viewing Serial Number	70
1.4. DISPLAYPORT FEATURES	11	6. SOFTWARE CONTROL - USING THE BUILT-IN WEB	39	8.3.4. Viewing the Installed Firmware	70
1.5. TYPICAL APPLICATION	12	6.1. ESTABLISHING THE CONNECTION.....	40	8.3.5. Viewing CPU Firmware Compile Time	70
1.6. MODEL COMPARISON	14	6.2. THE LAYOUT OF THE BUILT-IN WEB.....	40	8.3.6. Viewing Firmware of the Controller.....	70
2. PRODUCT OVERVIEW	16	7. SOFTWARE CONTROL - LIGHTWARE DEVICE CONTROLLER	41	8.3.7. Viewing Installed Motherboard.....	71
2.1. FRONT VIEW	17	7.1. INSTALL AND UPDATE.....	42	8.3.8. Viewing Crosspoint Size	71
2.2. REAR VIEW	18	7.2. RUNNING THE LDC.....	42	8.3.9. Viewing Router's Health	71
3. FRONT PANEL CONTROL	19	7.3. DEVICE DISCOVERY WINDOW	43	8.3.10. Querying Control Protocol (RS-232).....	71
3.1. FRONT PANEL BUTTONS OPERATIONS.....	20	7.4. CROSSPOINT MENU.....	44	8.4. CROSSPOINT OPERATIONS	72
3.1.1. View Crosspoint State.....	20	7.4.1. Grid View	44	8.4.1. Switching an Input to an Output	72
3.1.2. Switching Operations	20	7.4.2. Tile View.....	45	8.4.2. Switching an Input to All Outputs.....	72
3.1.3. Output Lock.....	21	7.5. INPUT PORT PROPERTIES	47	8.4.3. Batch Switching Outputs.....	72
3.1.4. Control Lock	22	7.5.1. HDMI Inputs	47	8.4.4. Viewing the Connection of an Output Port	73
3.1.5. Save or Load a Preset	22	7.5.2. DisplayPort Inputs	51	8.4.5. Viewing Connections of all Outputs	73
3.2. FRONT PANEL LCD MENU OPERATIONS.....	23	7.6. OUTPUT PORT PROPERTIES	54	8.4.6. Viewing Mutes on all Outputs.....	73
3.2.1. System Settings Menu	23	7.6.1. HDMI Outputs	54	8.4.7. Muting Specified Output	73
3.2.2. Input Ports Menu	24	7.6.2. Frame Detector	57	8.4.8. Unmuting Specified Output.....	74
3.2.3. Output Ports Menu	26	7.6.3. DisplayPort Outputs	57	8.4.9. Locking Specified Output.....	74
3.2.4. EDID Menu	28	7.7. PRESETS	60	8.4.10. Unlocking a Specified Output	74
3.2.5. Health Menu.....	29	7.8. EDID MENU	61	8.5. PRESET HANDLING	74
3.2.6. Presets Menu.....	29	7.8.1. Sources and Destinations	61	8.5.1. Loading a Preset.....	74
4. INSTALLATION	30	7.8.2. EDID Operations.....	62	8.6. LW2 COMMANDS - QUICK SUMMARY	75
4.1. MOUNTING OPTIONS	31	7.8.3. EDID Summary Window	62	9. LW3 PROGRAMMERS' REFERENCE	76
4.2. ELECTRICAL CONNECTIONS.....	32	7.8.4. Editing an EDID	63	9.1. OVERVIEW	77
4.2.1. HDMI Connector	32	7.8.5. Creating an EDID.....	63	9.2. INSTRUCTIONS FOR THE TERMINAL APPLICATION USAGE	77
4.2.2. DisplayPort Connector	32	7.8.6. Display ID Extension.....	64	9.3. PROTOCOL RULES	77
4.2.3. Symmetrical Analog Stereo Audio	32	7.9. SETTINGS MENU	65	9.3.1. LW3 Tree Structure and Command Structure (examples).....	77
4.2.4. RS-232 Port	33	7.9.1. Status Tab	65	9.3.2. General Rules.....	77
4.2.5. Ethernet (LAN) Port	33	7.9.2. Network Tab.....	65	9.3.3. Legend for the Control Commands.....	78
4.2.6. USB Connector.....	33	7.9.3. RS-232 Tab.....	66	9.3.4. Command Types.....	78
4.3. CONNECTING STEPS.....	34	7.9.4. Front Panel Tab.....	66	9.3.5. Prefix Summary	79
4.3.1. Powering On.....	34	7.9.5. System Tab	66	9.3.6. Error Messages.....	79
5. DEVICE CONCEPT	35	7.10. ADVANCED VIEW	67	9.3.7. Escaping.....	79
5.1. PORT DIAGRAM	36	8. LW2 PROGRAMMERS' REFERENCE	68	9.3.8. Signature.....	79
5.2. HDMI VIDEO OPTIONS.....	36	8.1. PROTOCOL DESCRIPTION	69	9.3.9. Subscription.....	79
		8.2. INSTRUCTIONS FOR THE TERMINAL APPLICATION USAGE	69	9.3.10. Notifications about the Changes of the Properties	80
				9.3.11. Legend for the Control Commands.....	80

Table of Contents

9.4. SYSTEM COMMANDS	80	9.9. HDMI OUTPUT SETTINGS	90	10.6. UPDATING VIA GUI	106
9.4.1. Querying the Product Name	80	9.9.1. Setting the Signal Type (HDMI mode).....	90	10.7. COMMAND LINE INTERFACE (CLI)	107
9.4.2. Setting the Device Label.....	80	9.9.2. Scrambling.....	90	10.7.1. How to Run	107
9.4.3. Querying the Serial Number.....	80	9.9.3. Setting the Signal Conversion Mode.....	90	10.7.2. How to Use	107
9.4.4. Resetting the Matrix	81	9.9.4. Sending CEC Commands Towards the Sink.....	91	10.8. CLI COMMANDS	107
9.4.5. Restoring the Factory Default Settings	81	9.10. DISPLAYPORT OUTPUT SETTINGS	92	10.8.1. Help	107
9.4.6. Querying the Operation Mode (Standby Mode) of the Matrix.....	81	9.10.1. Enabling DP Power.....	92	10.8.2. LDU2 Version	108
9.4.7. Switching to Standby Mode.....	81	9.10.2. Enabling Forced Link Training	92	10.8.3. Checking For New LDU2 Version.....	108
9.4.8. Switching to Normal Mode	81	9.10.3. Setting the Forced Lane Number	92	10.8.4. Device Info	108
9.5. SWITCHING AND CROSSPOINT SETTINGS	81	9.10.4. Setting the Forced Link Data Rate.....	92	10.8.5. Update.....	109
9.5.1. Querying the Video Crosspoint State	81	9.10.5. Setting the Swing / pre-emphasis	93	10.8.6. Restore	109
9.5.2. Switching an Input to an Output	82	9.10.6. Restarting Link Training	93	10.8.7. Package Options	110
9.5.3. Disconnecting the Output from any Input.....	82	9.11. AUDIO OUTPUT PORT SETTINGS	93	10.8.8. Complex Examples.....	110
9.5.4. Switching an Input to All Outputs.....	82	9.11.1. Audio Mode Setting.....	93	10.8.9. Exit Codes.....	111
9.5.5. Multiple Switching	82	9.11.2. Analog Audio Output Level Settings	94	10.9. IF THE UPDATE IS NOT SUCCESSFUL	111
9.5.6. Video Input Port Settings (HDMI and DisplayPort).....	83	9.12. PRESET HANDLING	95	11. TROUBLESHOOTING	112
9.5.7. Setting the HDCP State.....	83	9.12.1. Creating a New Preset	95	11.1. USE CASES	113
9.5.8. Muting an Input Port.....	83	9.12.2. Saving the Settings to an Existing Preset.....	95	11.2. HOW TO SPEED UP THE TROUBLESHOOTING PROCESS	114
9.5.9. Unmuting an Input Port.....	83	9.12.3. Loading a Preset.....	95	12. TECHNOLOGIES	115
9.5.10. Locking an Input Port.....	83	9.12.4. Renaming a Preset.....	95	12.1. EDID MANAGEMENT	116
9.5.11. Unlocking an Input Port	83	9.13. NETWORK SETTINGS	96	12.1.1. Understanding the EDID.....	116
9.5.12. Querying the Status of the Source Ports	84	9.13.1. Querying the Current IP Address.....	96	12.1.2. Advanced EDID Management.....	116
9.5.13. Setting the Audio Mode	85	9.13.2. Setting a Dynamic IP Address	96	12.2. HDCP MANAGEMENT	117
9.5.14. Sending CEC Commands Towards the Source	85	9.13.3. Static IP Address Settings	96	12.2.1. Protected and Unprotected Content	117
9.6. DISPLAYPORT INPUT SETTINGS	86	9.14. EDID MANAGEMENT	97	12.2.2. Disable Unnecessary Encryption.....	117
9.6.1. Setting the Maximum Lane Number	86	9.14.1. Querying the Emulated EDIDs.....	97	12.2.3. HDCP v2.2.....	118
9.6.2. Enabling DP Power.....	86	9.14.2. Setting the Emulated EDID.....	97	12.3. PIXEL ACCURATE RECLOCKING	119
9.6.3. Setting the Maximum Link Data Rate.....	86	9.14.3. Copying an EDID into the User EDID Memory.....	97	12.4. SERIAL MANAGEMENT	120
9.6.4. Enabling the Test Pattern.....	86	9.15. RS-232 PORT SETTINGS	98	12.4.1. General Information	120
9.6.5. Setting the Conversion Mode	87	9.15.1. Setting the Current Command Protocol.....	98	12.4.2. Types of Serial Cables.....	120
9.6.6. Restarting Link Training	87	9.15.2. Setting the Baud Rate.....	98	12.4.3. RS-232 Signal Transmission over MX2 Matrix switchers.....	120
9.7. AUDIO INPUT PORT SETTINGS	87	9.16. LW3 COMMANDS – QUICK SUMMARY	99	13. APPENDIX	121
9.7.1. Audio Mode Setting.....	87	10. FIRMWARE UPDATE	102	13.1. SPECIFICATIONS	122
9.7.2. Analog Audio Input Level Settings	87	10.1. BACKWARD COMPATIBILITY	103	13.2. APPLIED PORTS (NETWORK SETTINGS)	125
9.8. VIDEO OUTPUT PORT SETTINGS (HDMI AND DISPLAYPORT)	88	10.2. INTRODUCTION	103	13.3. FACTORY DEFAULT SETTINGS	125
9.8.1. Querying the Status of the Output Ports.....	88	10.3. PREPARATION	103	13.4. MECHANICAL DRAWINGS	126
9.8.2. Muting an Output.....	88	10.3.1. About the Firmware Package (LFP2 File)	103	13.5. CABLE WIRING GUIDE	129
9.8.3. Unmuting an Output	88	10.3.2. LDU2 Installation	103	13.5.1. Serial Ports	129
9.8.4. Locking an Output	89	10.4. RUNNING THE SOFTWARE	104	13.5.2. Audio Ports	129
9.8.5. Unlocking an Output.....	89	10.4.1. LDU2 Interfaces.....	104	13.6. FACTORY EDID LIST	130
9.8.6. Setting the HDCP Mode (Output Port)	89	10.5. THE UPDATING STEPS	105		
9.8.7. Setting the Audio Mode.....	89				

Table of Contents

13.7. FRONT AND REAR VIEWS WITH PORT NUMBERING	131
13.7.1. MX2-4x4-HDMI20-CA	131
13.7.2. MX2-8x4-HDMI20-CA	131
13.7.3. MX2-8x8-HDMI20-L	131
13.7.4. MX2-8x8-HDMI20-CA	131
13.7.5. MX2-8X8-HDMI20-Audio	132
13.7.6. MX2-8X8-HDMI20-Audio-L	132
13.7.7. MX2-8x8-DH-4DPi-A	132
13.7.8. MX2-8x8-DH-4DPio-A	132
13.7.9. MX2-8x8-DH-8DPi-A	133
13.7.10. MX2-8x8-DH-8DPio-A	133
13.7.11. MX2-16x8-HDMI20-Audio-R	133
13.7.12. MX2-16x16-HDMI20	134
13.7.13. MX2-16x16-HDMI20-Audio	134
13.7.14. MX2-16x16-HDMI20-R	135
13.7.15. MX2-16x16-HDMI20-Audio-R	135
13.7.16. MX2-16x16-DH-8DPi-A-R	136
13.7.17. MX2-16x16-DH-16DPi-R	136
13.7.18. MX2-24x24-HDMI20	137
13.7.19. MX2-24x24-HDMI20-Audio	137
13.7.20. MX2-24x24-HDMI20-R	138
13.7.21. MX2-24x24-HDMI20-Audio-R	138
13.7.22. MX2-24x24-DH-12DPi-R	139
13.7.23. MX2-24x24-DH-12DPi-A-R	139
13.7.24. MX2-24x24-DH-24DPio-A-R	140
13.7.25. MX2-32x32-HDMI20-A-R	140
13.7.26. MX2-32x32-DH-16DPi-A-R	141
13.7.27. MX2-48x48-HDMI20-A-R	141
13.7.28. MX2-48x48-DH-24DPio-A-R	142
13.7.29. MX2-48x48-DH-48DPi-A-R	142
13.7.30. MX2-48x48-DH-48DPio-A-R	143
13.8. DIRECTION OF THE AIRFLOW	143
13.9. RELEASE NOTES OF THE FIRMWARE PACKAGES	143
13.10. HASHTAG KEYWORD LIST	150
13.11. FURTHER INFORMATION	152

1

Introduction

Thank you for choosing Lightware MX2 series matrix switcher. In the first chapter we would like to introduce the device, highlighting the most important features in the sections listed below:

- ▶ DESCRIPTION
- ▶ BOX CONTENTS
- ▶ FEATURES FOR ALL MODELS
- ▶ DISPLAYPORT FEATURES
- ▶ TYPICAL APPLICATION
- ▶ MODEL COMPARISON

1.1. Description

The MX2-HDMI20 series is the Lightware HDMI 2.0 standalone matrix switcher family that supports uncompromised 4K UHD resolution at 60Hz 4:4:4, and allows de-embedding audio from, and embedding audio to the HDMI stream. It has an outstanding port density that makes it particularly suitable for rental and fix install applications, as well as for future-proof operation centers. It is a perfect choice for installations where HDMI 2.0 compliant input and output ports are required.

This flagship product has HDMI2.0 inputs and HDMI2.0 outputs transmitting up to 4K at 60Hz in 4:4:4 format, while supporting 3D, Dolby TrueHD, and DTS-HD Master Audio. Each input port has audio connectors for embedding analog audio into the HDMI stream. Likewise, the audio connectors next to the output ports can provide de-embedded audio * for amplifiers and audio systems.

DisplayPort Parameters are displayed in unprecedented detail, and also allow adjustment in various aspects, such as link data rate and link lane count. Plus, the Restart Link Training feature allows users to reset link training within the software to ensure correct link profiling, without the need to physically unplug/re-plug a device.

MX2 matrix switchers are available with 32x32 and 48x48 crosspoint sizes, with or without analog audio add-ons, and some versions are also available with redundant power sources, paired with rugged power connectors and reinforced control ports. All models feature a front panel, color LCD screen with great visibility, and a jog-dial, multi-function button, enabling the users to manage every device feature and service directly.

Further product variants have been developed to better serve various target application requirements, in 8x8, 8x4 and 4x4 crosspoint sizes. The new compact variants are excellent choices for not only Rental & Staging, but also for various corporate and other collaborative environments.

* Please note that only stereo LPCM can be de-embedded from the HDMI signal.

About the Serial Number

Lightware devices contain a label indicating the unique serial number of the product. The structure is the following:

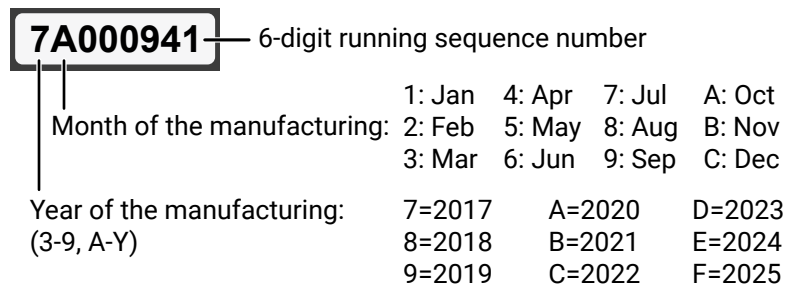



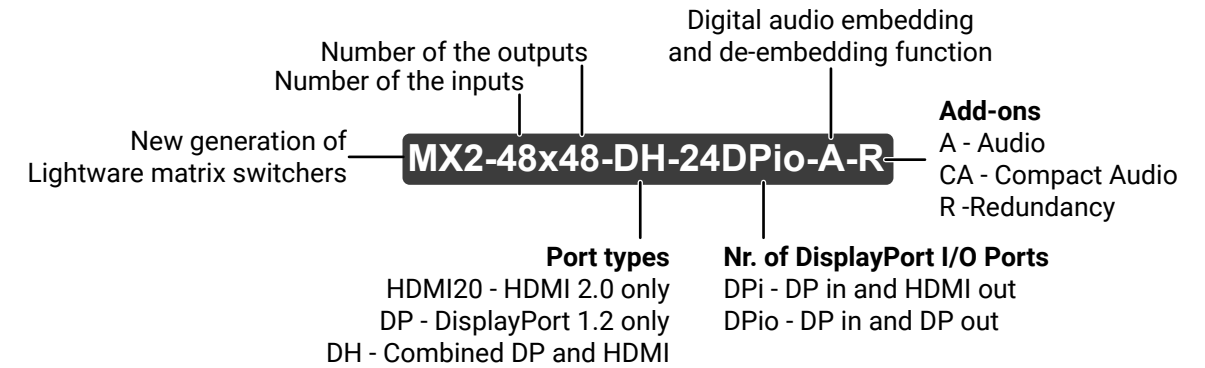





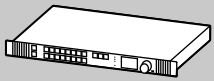

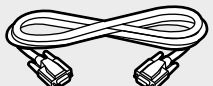

Model Denomination

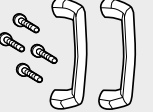
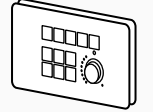

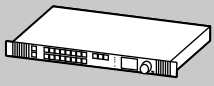
1.2. Box Contents

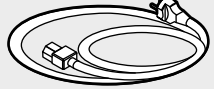
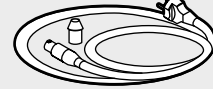
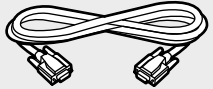
The optional (not-supplied) accessories can be purchased and used with the device; please contact sales@lightware.com.

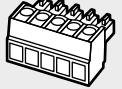
	Supplied device	Supplied accessories							Optional accessories
	 Matrix switcher	 Safety and Warranty Info, QSG	 IEC power cable	 Neutrik powerCON power cable	 Serial data cable (male-female)	 Phoenix® Combicon 3-pole connector	 Phoenix® Combicon 5-pole connector	 Handle pair with 4 pcs M5 flat head screws	 Room Automation Device series (RAP-B511 / RAC-B501)
MX2-4x4-HDMI20-CA	✓	✓	✓	-	-	✓	2x	-	✓
MX2-8x4-HDMI20-CA	✓	✓	✓	-	-	✓	4x	-	✓
MX2-8x8-HDMI20-CA	✓	✓	✓	-	-	✓	4x	-	✓
MX2-8x8-HDMI20-L	✓	✓	✓	-	-	✓	-	-	✓
MX2-8X8-HDMI20-Audio	✓	✓	✓	-	-	✓	16x	-	✓
MX2-8X8-HDMI20-Audio-L	✓	✓	✓	-	-	✓	16x	-	✓
MX2-8x8-DH-4DPi-A	✓	✓	✓	-	-	✓	2x	-	✓
MX2-8x8-DH-4DPio-A	✓	✓	✓	-	-	✓	16x	-	✓
MX2-8x8-DH-8DPi-A	✓	✓	✓	-	-	✓	8x	-	✓
MX2-8x8-DH-8DPio-A	✓	✓	✓	-	-	✓	16x	-	✓
MX2-16x8-HDMI20-Audio-R	✓	✓	-	2x	✓	✓	12x	-	✓
MX2-16x16-HDMI20	✓	✓	✓	-	-	✓	-	-	✓
MX2-16x16-HDMI20-Audio	✓	✓	✓	-	-	✓	12x	-	✓
MX2-16x16-HDMI20-R	✓	✓	-	2x	✓	-	-	-	✓
MX2-16x16-HDMI20-Audio-R	✓	✓	-	2x	✓	-	12x	-	✓
MX2-16x16-DH-8DPi-A-R	✓	✓	-	2x	✓	-	16x	-	✓
MX2-16x16-DH-16DPi-R	✓	✓	-	2x	✓	-	-	-	✓

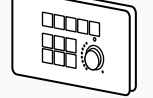
	Supplied device	Supplied accessories							Optional accessories
	 Matrix switcher	 Safety and Warranty Info, QSG	 IEC Power Cable	 Neutrik powerCON Power cable	 Serial data cable (male-female)	 Phoenix® Combicon 3-pole Connector	 Phoenix® Combicon 5-pole Connector	 Handle pair with 4 pcs M5 flat head screws	 Room Automation Device series (RAP-B511 / RAC-B501)
MX2-24x24-HDMI20	✓	✓	✓	-	-	✓	-	-	✓
MX2-24x24-HDMI20-Audio	✓	✓	✓	-	-	✓	16x	-	✓
MX2-24x24-HDMI20-R	✓	✓	-	2x	✓	-	-	-	✓
MX2-24x24-HDMI20-Audio-R	✓	✓	-	2x	✓	-	16x	-	✓
MX2-24x24-DH-12DPi-R	✓	✓	-	2x	✓	-	-	-	✓
MX2-24x24-DH-12DPi-A-R	✓	✓	-	2x	✓	-	20x	-	✓
MX2-24x24-DH-24DPio-A-R	✓	✓	-	2x	✓	-	20x	-	✓
MX2-32x32-HDMI20-A-R	✓	✓	-	2x	✓	-	32x	✓	✓
MX2-32x32-DH-16DPi-A-R	✓	✓	-	2x	✓	-	28x	✓	✓
MX2-48x48-HDMI20-A-R	✓	✓	-	2x	✓	-	32x	✓	✓
MX2-48x48-DH-24DPio-A-R	✓	✓	-	2x	✓	-	32x	✓	✓
MX2-48x48-DH-48DPi-A-R	✓	✓	-	2x	✓	-	32x	✓	✓
MX2-48x48-DH-48DPio-A-R	✓	✓	-	2x	✓	-	32x	✓	✓

1.3. Features for All Models

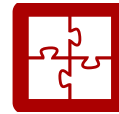

Maximum AV Compatibility

The matrix is compatible with the latest HDMI 2.0 standard, as well as with HDMI 1.x and DVI 1.0 standards.



4K Video without Compression

HDMI 2.0 signal switching with 4k@60Hz and RGB 4:4:4 color space, 18 Gbit/sec bandwidth.



HDCP Compliant

MX2-HDMI20 matrix switchers fulfill the HDCP standard. HDCP capability on the HDMI inputs can be disabled when non-protected content is extended.



Audio Embedding and De-embedding

In the -A or -Audio suffixed models, each input port has audio connectors for embedding analog audio to the HDMI stream. Likewise, the audio connectors next to the output ports can provide de-embedded audio for amplifiers and audio systems.



Advanced EDID Management

The user can emulate any EDID on the inputs independently, read out and store any attached monitor's EDID in 100 internal memory locations, upload and download EDID files using Lightware Device Controller software.



Pixel Accurate Reclocking

Each output has a clean, jitter free signal, eliminating signal instability and distortion caused by long cables or connector reflections.



Frame Detector and Signal Analysis

The exact video and audio signal format can be determined, such as timing, frequencies, scan mode, HDCP encryption, color range, color space and audio sample rate.

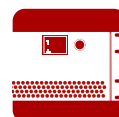

Graphic Display and Rotary Jog Dial Control Knob

Easy setting and menu navigation are assured by the color graphic display and the comfortable jog dial control.



Built-in Website

Easy access from a web browser to control and configure the devices – even with a mobile device.



Unique Front-to-Back Cooling Airflow Design

The matrix includes a groundbreaking new cooling design with front-to-back airflow. Inside the chassis, the airflow travels along guiding panes, ensuring that the most warm areas receive ample amount of cooling air volume.



Ethernet Control

Multiple simultaneous TCP/IP connections are available with a simple ASCII-based protocol for controlling, configuring the matrix router or performing a firmware update.



Non-Volatile Memory

The matrix router starts with its latest configuration settings when powered on or after a power failure. Every setting is stored in a non-volatile memory.



Consumer Electronic Control

Supports transmitting standard CEC commands in order to remote control the source or sink device.



HDMI 2.0 to 2x HDMI 1.4 Splitting

The device supports vertical splitting of an HDMI2.0 4k@60Hz 4:4:4 input signal to left and right halves, allowing for the transmission of an 18 Gbps HDMI 2.0 signal over two HDMI1.4 compliant links. The two halves can then be recombined at the signal destination.

DIFFERENCE: Only the MX2-8X8-HDMI20-AUDIO-L model is able to split the video signal. The availability of the splitting feature also depends on the hardware version of the output board (V1x_). The hardware version can be found in [Status Tab](#) in the LDC or in the [System Settings Menu](#), [Device Info](#) submenu in the LCD.

1.4. DisplayPort Features

DIFFERENCE: DisplayPort inputs are available in certain models, -D letter the model name indicates that (see the [Model Comparison](#) table).



Restart Link Training

Allows the DisplayPort Link Training to be restarted in case of no signal or bad quality, without unplugging the cable



DisplayPort Diagnostics and Management

Provides detailed DisplayPort-specific connectivity information: AUX handshaking, 1/2/4 lane count, RBR/HBR/HBR2 datarates. DisplayPort AUX-channel analyzer helps debugging and analyzing handshaking problems

1.5. Typical Application

MX2-8x8-HDMI20-Audio



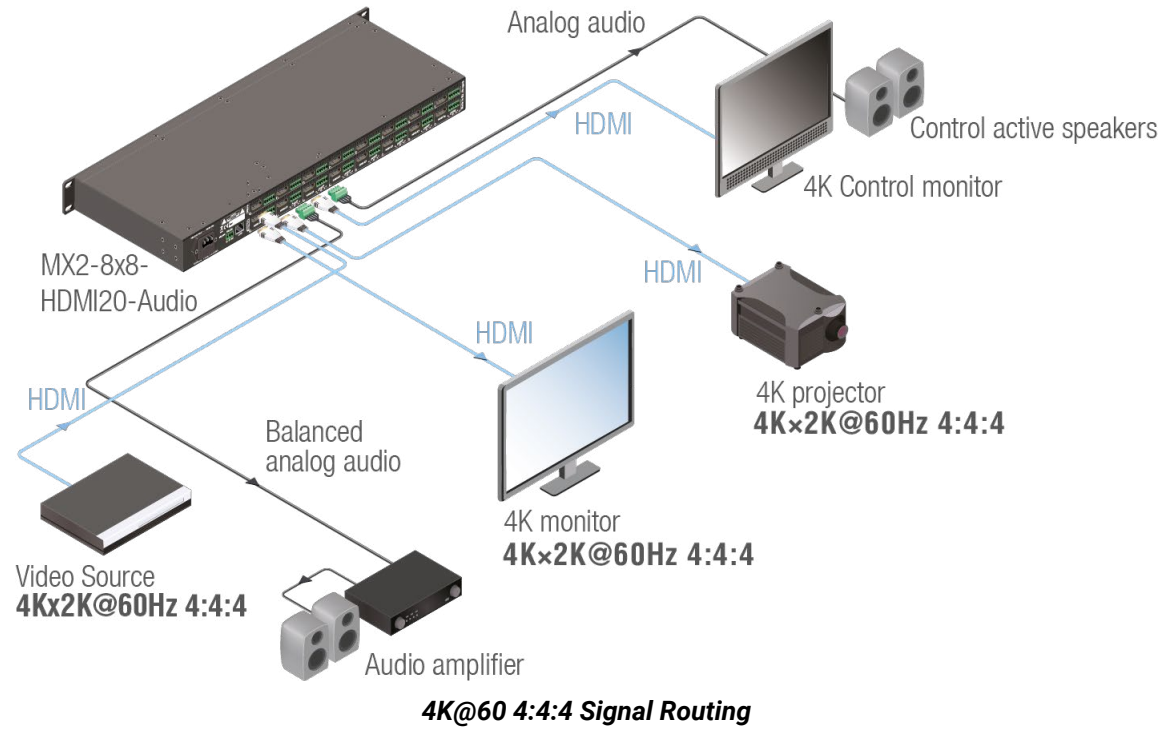



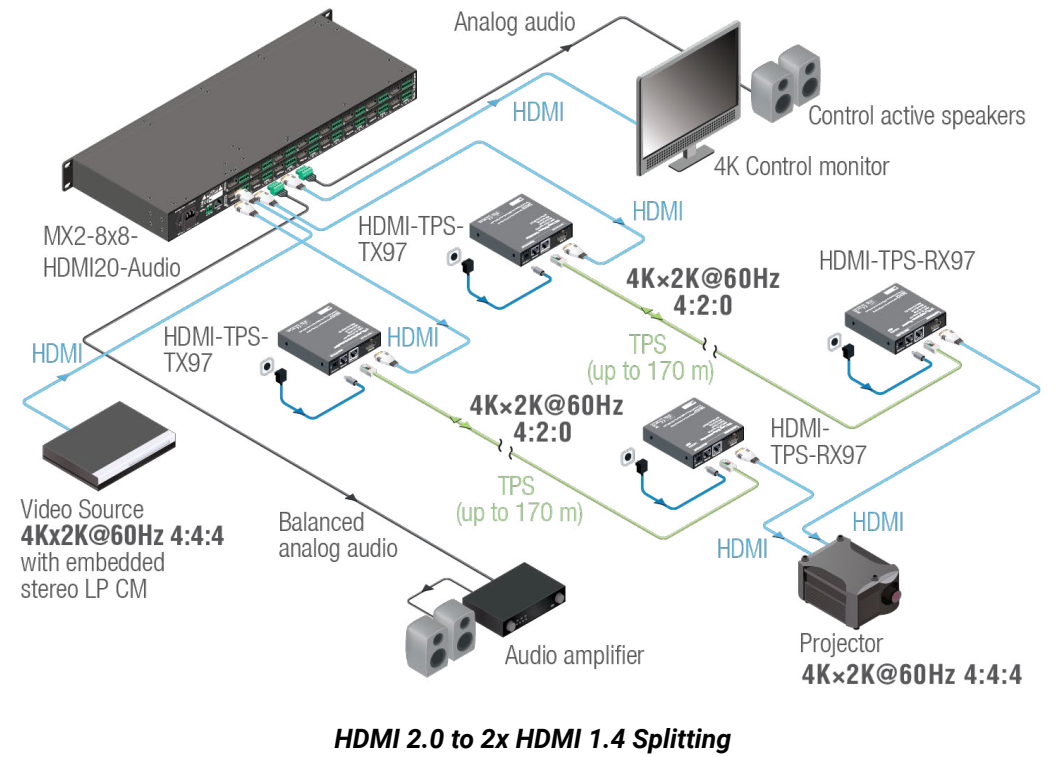



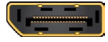

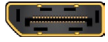
The following figures show different modes of the application:

















MX2-8x8-HDMI20-Audio

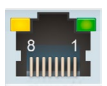

1.6. Model Comparison

	Inputs			Outputs				Redundant power supply	Control Ports				Front panel I/O buttons	Front panel LCD menu	Enclosure
	HDMI	DP	Audio	HDMI	DP	Audio	Audio (independent)		powerCON	RJ45	etherCON	3-pole Phoenix			
															
MX2-4x4-HDMI20-CA	4*	-	-	4*	-	2 HDMI	-	-	✓	-	✓	-	-	✓	1 RU
MX2-8x4-HDMI20-CA	8*	-	2 HDMI	4*	-	2 HDMI	-	-	✓	-	✓	-	-	✓	1 RU
MX2-8x8-HDMI20-CA	8*	-	2 HDMI	8*	-	2 HDMI	-	-	✓	-	✓	-	-	✓	1 RU
MX2-8x8-HDMI20-L	8*	-	-	8*	-	-	-	-	✓	-	✓	-	✓	✓	1 RU
MX2-8X8-HDMI20-Audio	8*	-	8 HDMI	8*	-	8 HDMI	-	-	✓	-	✓	-	✓	✓	1 RU
MX2-8X8-HDMI20-Audio-L	8*	-	8 HDMI	8*	-	8 HDMI	-	-	✓	-	✓	-	✓	✓	1 RU
MX2-8x8-DH-4DPi-A	4*	4	-	8*	-	2 HDMI	-	-	✓	-	✓	-	✓	✓	1 RU
MX2-8x8-DH-4DPi-A	4*	4	4 HDMI + 4 DP	4*	4	4 HDMI + 4 DP	-	-	✓	-	✓	-	✓	✓	1 RU
MX2-8x8-DH-8DPi-A	-	8	4 DP	8*	-	4 HDMI	-	-	✓	-	✓	-	✓	✓	1 RU
MX2-8x8-DH-8DPi-A	-	8	4 DP	-	8	8 DP	-	-	✓	-	✓	-	✓	✓	1 RU
MX2-16x8-HDMI20-Audio-R	16	-	4 HDMI	8	-	4 HDMI	4	✓	-	✓	-	✓	-	✓	3 RU
MX2-16x16-HDMI20	16	-	-	16	-	-	-	-	✓	-	✓	-	✓	✓	3 RU
MX2-16x16-HDMI20-Audio	16	-	4 HDMI	16	-	4 HDMI	4	-	✓	-	✓	-	-	✓	3 RU
MX2-16x16-HDMI20-R	16	-	-	16	-	-	-	✓	-	✓	-	✓	-	✓	3 RU
MX2-16x16-HDMI20-Audio-R	16	-	4 HDMI	16	-	4 HDMI	4	✓	-	✓	-	✓	-	✓	3 RU
MX2-16x16-DH-8DPi-A-R	8	8	8 HDMI	16	-	4 HDMI	4	✓	-	✓	-	✓	✓	✓	3 RU
MX2-16x16-DH-16DPi-R	-	16	-	16	-	-	-	✓	-	✓	-	✓	✓	✓	3 RU

* 1 RU matrix models are assembled **without HDMI flange screws**.

	Inputs			Outputs				Redundant power supply	Control Ports				Front panel I/O buttons	Front panel LCD menu	Enclosure
	HDMI	DP	Audio	HDMI	DP	Audio	Audio (independent)	powerCON	RJ45	etherCON	3-pole Phoenix	D-SUB			
															
MX2-24x24-HDMI20	24	-	-	24	-	-	-	-	✓	-	✓	-	✓	✓	4 RU
MX2-24x24-HDMI20-Audio	24	-	8 HDMI	24	-	8 HDMI	-	-	✓	-	✓	-	-	✓	4 RU
MX2-24x24-HDMI20-R	24	-	-	24	-	-	-	✓	-	✓	-	✓	✓	✓	4 RU
MX2-24x24-HDMI20-Audio-R	24	-	8 HDMI	24	-	8 HDMI	-	✓	-	✓	-	✓	-	✓	4 RU
MX2-24x24-DH-12DPi-R	12	12	-	24	-	-	-	✓	-	✓	-	✓	✓	✓	4 RU
MX2-24x24-DH-12DPi-A-R	12	12	8 HDMI + 4 DP	24	-	8 HDMI	-	✓	-	✓	-	✓	✓	✓	4 RU
MX2-24x24-DH-24DPi-A-R	-	24	8 DP	-	24	24 HDMI	-	✓	-	✓	-	✓	✓	✓	4 RU
MX2-32x32-HDMI20-A-R	32	-	16 HDMI	32	-	8 HDMI	8	✓	-	✓	-	✓	✓	✓	8 RU
MX2-32x32-DH-16DPi-A-R	16	16	8 HDMI + 4 DP	32	-	8 HDMI	8	✓	-	✓	-	✓	✓	✓	8 RU
MX2-48x48-HDMI20-A-R	48	-	16 HDMI	48	-	16 HDMI	-	✓	-	✓	-	✓	✓	✓	8 RU
MX2-48x48-DH-24DPi-A-R	24	24	8 HDMI + 8 DP	24	24	8 HDMI + 24 DP	-	✓	-	✓	-	✓	✓	✓	8 RU
MX2-48x48-DH-48DPi-A-R	-	48	16 DP	48	-	16 HDMI	-	✓	-	✓	-	✓	✓	✓	8 RU
MX2-48x48-DH-48DPi-A-R	-	48	16 DP	-	48	48 DP	-	✓	-	✓	-	✓	✓	✓	8 RU

2

Product Overview



The following sections are about the physical structure of the device, input/output ports and connectors:

- ▶ [FRONT VIEW](#)
- ▶ [REAR VIEW](#)

2.1. Front View

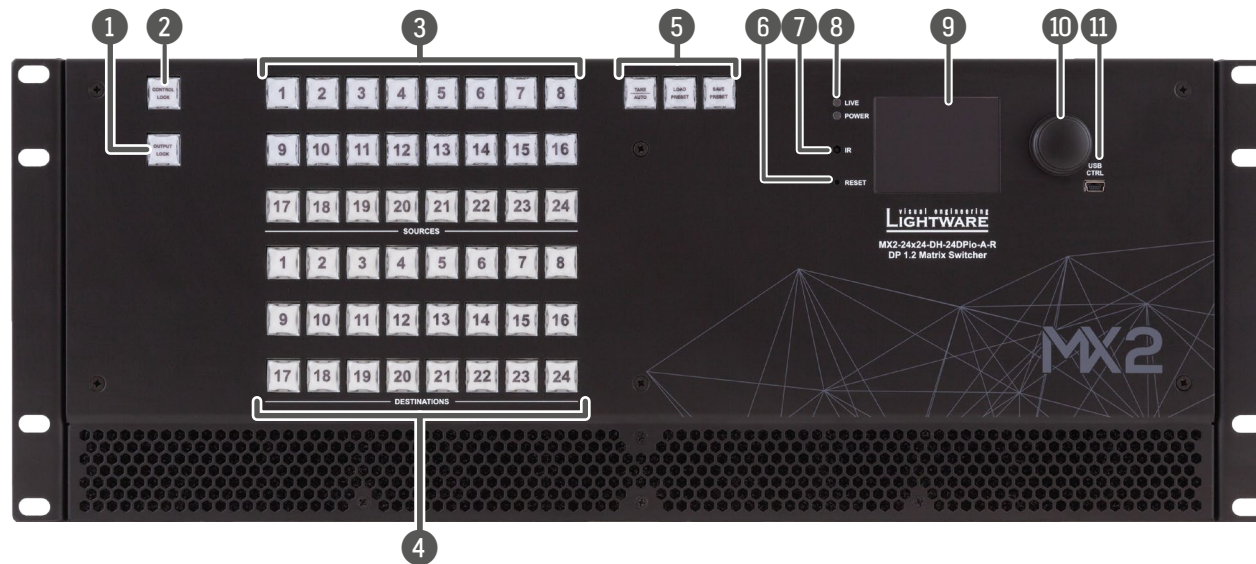
MX2-24x24-DH-24DPio-A-R



- 1 **Output Lock *** Locking one or more outputs.
- 2 **Control Lock *** Disable or enable front panel operations. Red light means the switching and function buttons are disabled.
- 3 **Sources *** Buttons to select an input, to select a preset number or to view the state of the selected input port.
- 4 **Destinations *** Buttons to select an output or to view the state of an output.
- 5 **Function Buttons *** Switching between working modes (Take / Autotake) and performing Preset operations.
- 6 **Reset Button** Reboots the matrix (the same as disconnecting from the power source and reconnecting again).
- 7 **IR Detector** Reserved for future developments.
- 8 **LIVE LED**  blinking slow The unit is on and operates properly.
- POWER LED**  on POWER LED indicates that the unit is powered on.
-  off The unit is powered off or it has an internal voltage problem.
- 9 **Color Display** LCD screen showing the most important settings and parameters in the front panel menu.
- 10 **Jog Dial Control Knob** Easy setting and menu navigation by the jog dial control. Turn and click the knob while getting feedback on the LCD.
- 11 **USB Control** USB connector for local control functions (e.g. Lightware Device Controller software).

* All models have front panel LCD and jog dial knob on the front, but some models are not supplied with front panel buttons. See the details about the difference in the models in the [Model Comparison](#) table.

2.2. Rear View

MX2-24x24-DH-24DPio-A-R

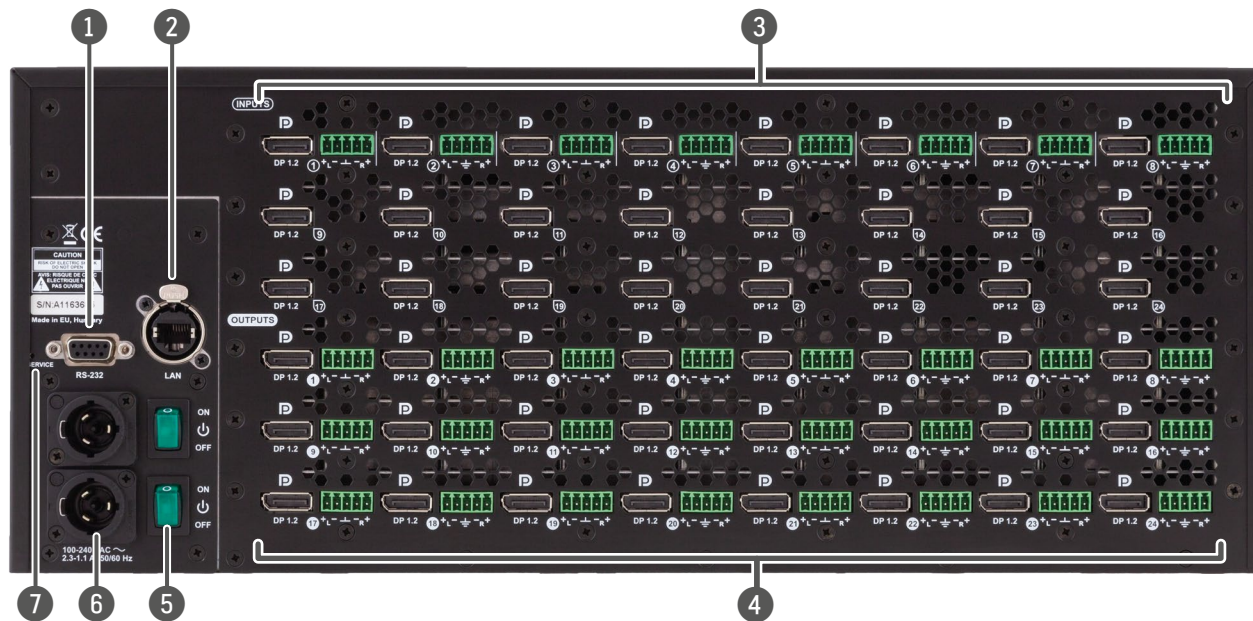

- 1 **RS-232 Port**
 - -R suffixed models: 9-pole D-SUB connector.
 - Other models: 3-pole Phoenix connector.
- 2 **LAN Port**
 - -R suffixed models: Neutrik etherCON connector for Ethernet/LAN connection.
 - Other models: RJ45 connector to control the matrix via LAN/Ethernet.
- 3 **Input Ports**

HDMI input ports are able to receive HDMI 2.0 video signal. **-H** in the model name indicates that the matrix has a HDMI connector.

-D in the model name means that the matrix has a DisplayPort input connector for accepting DP1.2 video signal.

Audio input ports (5-pole Phoenix) for balanced analog audio input signal (in **-A** and **-Audio** suffixed models).

See the details about the difference in the models in the [Model Comparison](#) table.
- 4 **Output Ports**

HDMI or DP output ports for connecting sink devices.

Audio output ports (5-pole Phoenix) for balanced analog audio output signal. The signal is de-embedded from the given video port (in **-A** suffixed models).
- 5 **Power Switch**
 - The matrix can be switched on/off by the power switch.
 - The 1U-high matrix switchers are not supplied with a power switch.
- 6 **AC Connector**
 - -R suffixed models: two Neutrik powerCON connector accepting 100-240 V, 50 or 60 Hz. For more details about the redundant supply, see the [Front Panel Buttons Operations](#) section.
 - In the other models: Standard IEC connector accepting 100-240 V, 50 or 60 Hz.
- 7 **Service Button** Hidden button for special operations.

3

Front Panel Control

This chapter is about the operation of the device, describing the functions that are available by the front/rear controls:

- ▶ [FRONT PANEL BUTTONS OPERATIONS](#)
- ▶ [FRONT PANEL LCD MENU OPERATIONS](#)

3.1. Front Panel Buttons Operations

DIFFERENCE: Some models have buttons on the front side (see the details about it in the [Model Comparison](#) table). They have the same functionality, only the number of source and destination buttons is different.

Take / Autotake Mode

The router has two different switching modes: **Take** and **Autotake**. If the **Take** button is unlit, **Take** mode is active. When the **Take** button continuously shines green, **Autotake** mode is selected. Press and hold the **Take** button for two seconds to change between **Take** and **Autotake** modes. `#button #crosspoint #switch #takemode #autotakemode`

3.1.1. View Crosspoint State

The current switching status can be checked on the front panel by using the front panel buttons. The crosspoint state is displayed slightly differently in **Take** or **Autotake** modes because of the different switching methods.

INFO: View mode does not mean that the router has to be switched in different modes, viewing and switching can be done after each other, without pressing any special buttons.

View Current State in Take Mode

If the router is in **Take** mode, the user can verify both input and output connections. In **Take** mode no accidental change can be done, unless **Take** button is pressed.

Press and release a **source button**. Now the selected source button and all destination buttons that are currently connected to the selected source will light up. This informative display will remain active for three seconds, then all buttons turn dark.

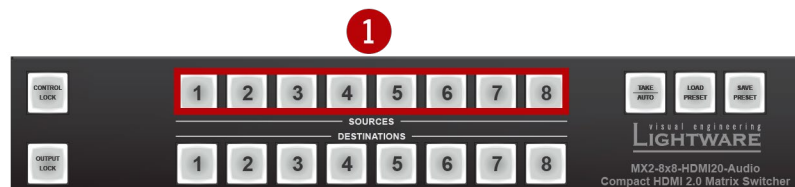

If every source, destination, and **Take** buttons are unlit (the unit is in **Take** mode, and no input was selected in the last 3 seconds), press and release a **destination button** to see its current state. Now the source button that is connected to the selected destination will light up.

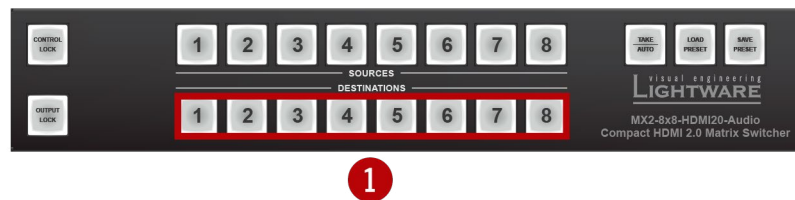

View Current State in Autotake Mode

In **Autotake** mode only states of destinations can be viewed.

Press and release the required **destination button**. Now the source button that is connected to the selected destination will light up.

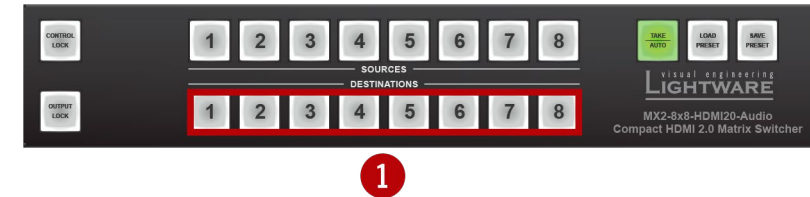

3.1.2. Switching Operations

Switching in Take Mode



Take mode allows the user to connect or disconnect multiple outputs to an input at once. This mode is useful when the time delay is not allowed between multiple switching. The commands are only realized when the **Take** button is pressed.

Step 1. First, press and release the desired **source button**. The pressed source button and all destination buttons that are currently connected to the source light up.

Step 2. Press and release the desired **destination buttons** that have to be (dis)connected to/from the selected source. The preselected destination buttons will blink. If no button is pressed for three seconds, the buttons will turn dark.

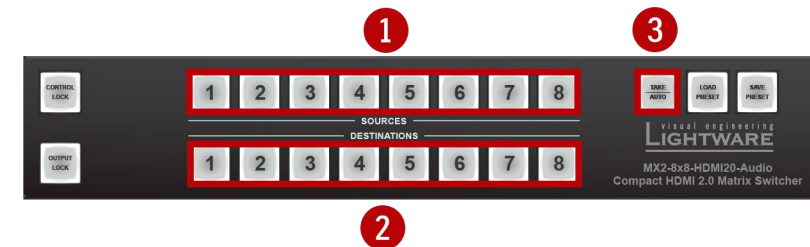

Step 3. Press and release **Take** button; the selected input is switched to the selected output(s).

Switching in Autotake Mode



Autotake mode is useful when immediate actions must be done or fast switching is needed between sources on a particular destination. In this mode switching occurs immediately upon pressing one of the input selector buttons.

Step 1. Press and release the desired **destination button**. The pressed destination button and the currently connected source button will light up green. If no source is connected (the output is muted), no source button will light up.

Step 2. Press and release the desired **source button**. The switch action will be executed immediately. Switching

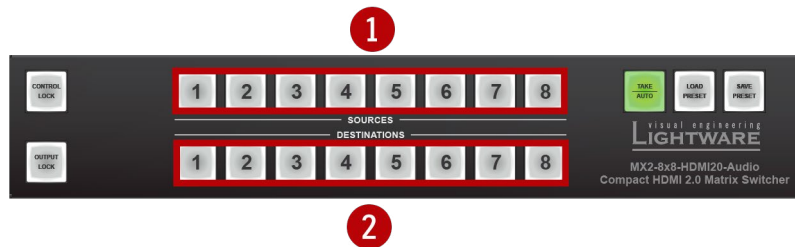

between sources to the selected destination can be done directly.

3.1.3. Output Lock

ATTENTION! While the front panel buttons allow locking only the output ports, the input ports can also be locked by using Lightware Device Controller software (see the [HDMI Inputs](#) section) or sending an LW3 protocol command (see the [Locking an Input Port](#) section).



Using Lightware routers, it is possible to lock a destination. This feature prevents accidental switching to the locked destination in case of an important signal. Locking a destination means that no input selection or muting action can be executed on that particular destination.

Destinations can be independently locked or unlocked. Locking a destination does not affect other destinations.

Output Lock in Take Mode #outputlock

Step 1. Press and release the **Output Lock** button; it starts to blink and all the buttons of any locked destinations light up (view state).

Step 2. Press and release a **destination button**; it starts to blink (more destinations can be selected sequentially).

Step 3. Press and release **Take** button. The selected destinations are now locked.

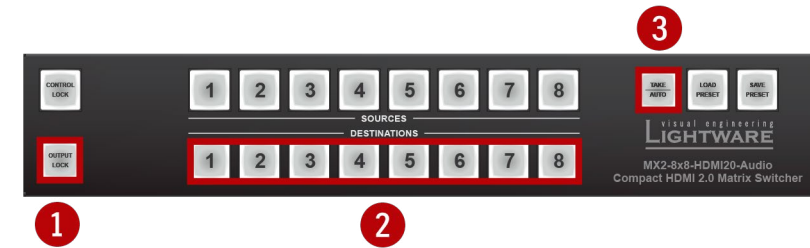

Output Lock in Autotake Mode

Step 1. Press and release the required **destination button**. Now the selected destination button and the currently configured source button light up (view mode).

Step 2. Press and release the **Output Lock** button; it lights up in red, and lock function is activated at once. No source can be changed at the locked destination.

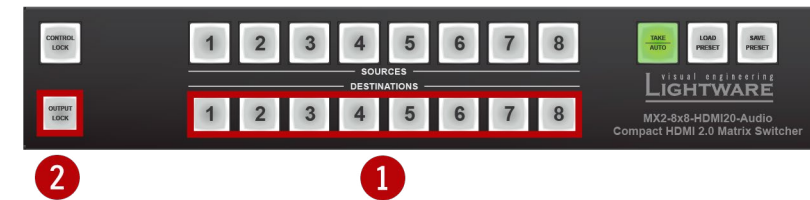

3.1.4. Control Lock



Front panel button operation can be enabled or disabled using **Control Lock** button, while the remote control is still enabled. If the button is unlit, front panel button operation is enabled. If the button is continuously shining in red the front panel operations are not possible. Press and keep the **Control Lock** button pressed for three seconds to toggle between the control lock states. `#controllock`

3.1.5. Save or Load a Preset



The matrix can store user-programmable presets. Each preset stores a configuration regarding all input connections for all outputs. All presets are stored in a non-volatile memory; the router keeps the presets, even in the case of a power down. Please note that preset operations can be followed on the LCD during front panel preset operations.

ATTENTION! Eight of the memory slots are available by the Source buttons; see the [Presets](#) section for the details.

Saving a Preset in Take Mode `#preset`

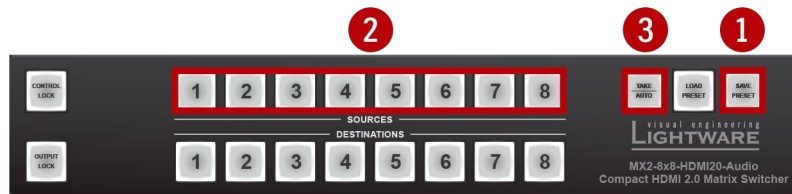

Step 1. Press and release **Save Preset** button.

Step 2. Press and release the desired **source (memory address) button** (source 1 to 8).

Step 3. Press and release the **Take** button. Now the current configuration is stored in the selected memory.

ATTENTION! Preset save action always stores the current configuration for all outputs.

Loading a Preset in Take Mode

Step 1. Press and release the **Load preset** button.

Step 2. Press and release the desired **source (memory address) button** (source 1 to 8).

Step 3. Press and release the **Take** button. Now the selected preset is loaded.

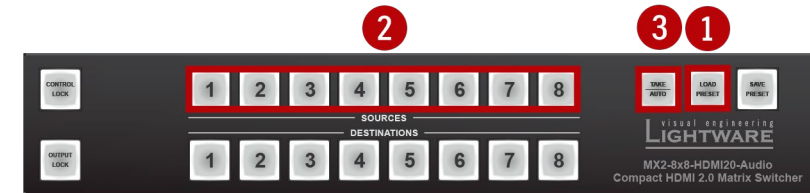

Saving a Preset in Autotake Mode

Step 1. Press and release the **Save Preset** button.

Step 2. Press and release the desired source (memory address) button (source 1 to 8). Now the current configuration is stored in the selected memory.

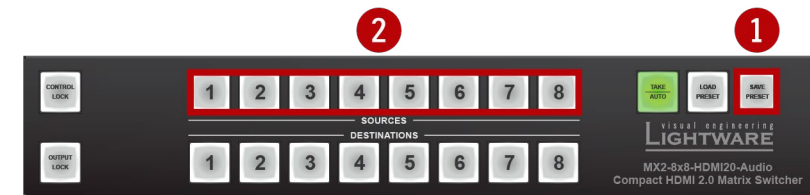

ATTENTION! Preset save action always stores the current configuration for all outputs.

Loading a Preset in Autotake Mode

Step 1. Press and release **Load Preset** button.

Step 2. Press and release the desired source (memory address) button (source 1 to 8). Now the selected preset is loaded.

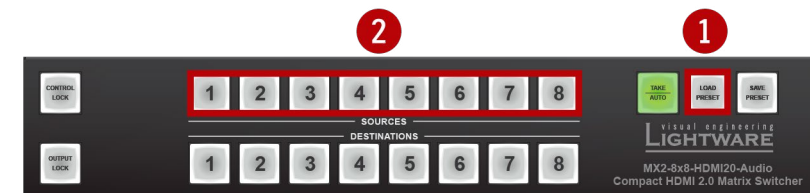

3.2. Front Panel LCD Menu Operations

The company logo is displayed on the screen during the boot-up. The main menu is displayed after about 30 seconds, and the device is ready to use.

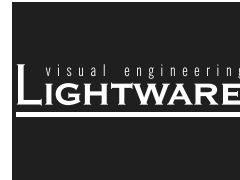

Menu Structure

The front panel has a color LCD that shows the most important settings and parameters structured in a menu. The jog dial control knob can be used to navigate between the menu items or change the value of a parameter. The knob can be pressed to enter a menu or edit/set a parameter.

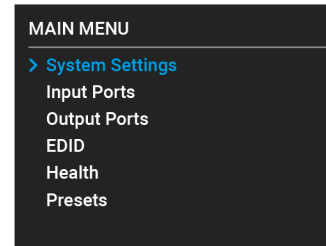
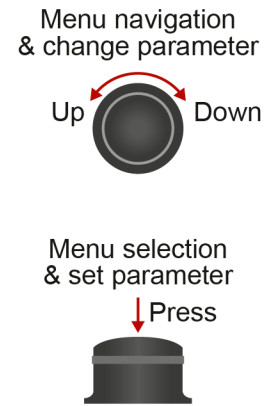
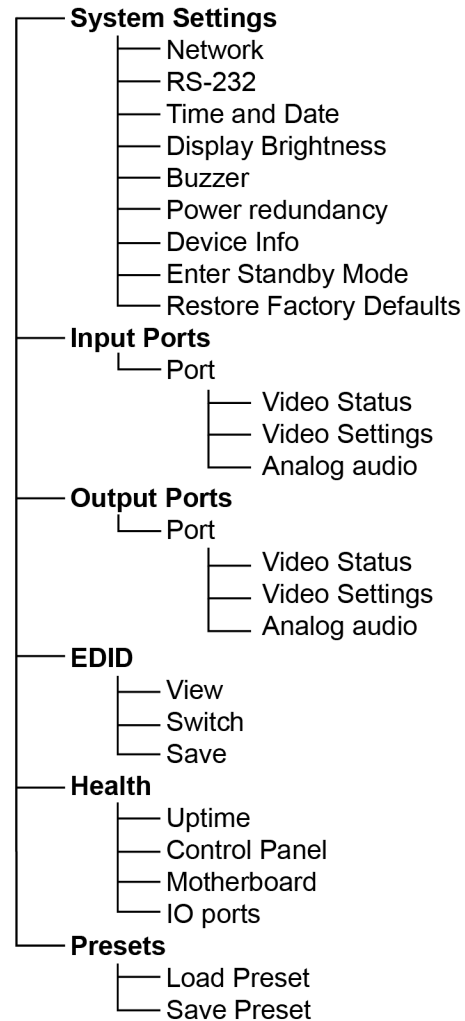

Parameter Selection

The **blue** colored line means the selected menu/parameter, the **green** one means the current setting.

TIPS AND TRICKS: The faster you rotate the jog dial, the faster the parameter list is scrolled.

Enter the menu/ submenu

> Icon before the line indicates the additional submenus. Click with the rotary to enter.

Blue dot shows that there is no submenu or setting possibility.

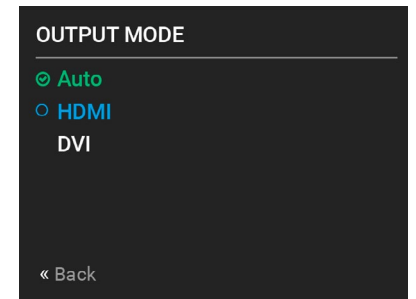
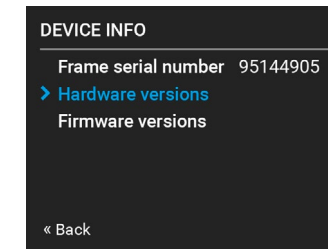
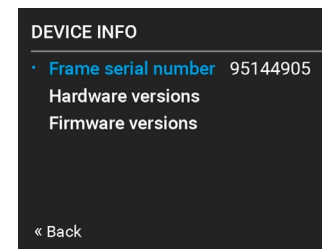

3.2.1. System Settings Menu

Network Submenu

The parameters of the network connection can be set in this submenu. The first three lines (IP, Subnet, and Gateway parameters) show the current settings. If the DHCP option is disabled, three more parameters are listed that can be set for a static IP address:

- **Static IP,**
- **Static Subnet,**
- **Static Gateway.**

ATTENTION! If you change the network settings, always press the Save option under Network menu (not only in the submenu of the parameter) to apply the new settings. `#network #ipaddress #dhcp`

Network security feature can be enabled or disabled in this submenu.

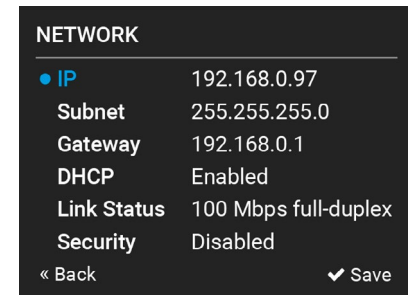

RS-232 Submenu

Adjustable parameters of the port:

- **Control** (enable/disable the device control),
- **Baud Rate** (9600, 19200, 38400, 57600, 115200),
- **Protocol** (LW2, LW3 or P#2 protocol). `#rs232 #rs-232 #serial`

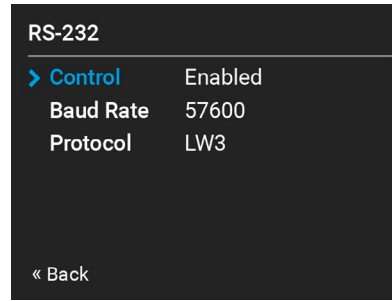

Time and Date

The internal clock and date can be set in this submenu, which is used for logging events. `#time #date`

Display Brightness

The brightness of the LCD can be set from 1 to 10 on a scale.

ATTENTION! The lowest value of the brightness parameter is 1 when setting via the front panel. The setting is available in Lightware Device Controller software as well, but in that case the lowest value is 0, which means the display is switched off; see the [Front Panel Tab](#) section.

INFO: When the matrix is in Standby mode, the display is switched off.

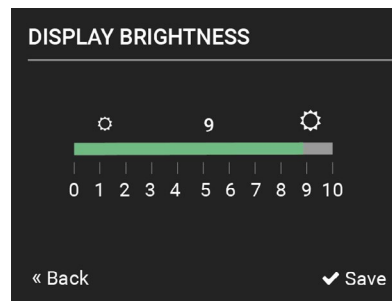

Buzzer

There is a buzzer (beeper) in the matrix that gives off a sound in certain cases (during booting, network or parameter change, etc.). It can be enabled/disabled in this submenu.

Power Redundancy `#power #redundancy`

DIFFERENCE: This submenu appears when the model has a redundant power supply (-R suffix in the model name shows this feature).

- PSU1: running / stopped
- PSU2: running / stopped

Device Info

The following information is available in the submenu:

- **Frame Serial Number**,
- **Hardware Versions** of the PCB components,
- **Firmware Versions** of the installed boards.

Enter Standby Mode `#standby`

The device can be switched to standby mode. In this case the video transmission is disabled and the LCD is switched off. Remote connections (LAN, RS-232) remain enabled. Press the jog dial button on the front panel to wake up the matrix (or see the related settings in LDC, see the [Grid View](#) section).

Restore Factory Defaults `#factory`

The default settings can be reloaded in this submenu, for details see [Factory Default Settings](#).

3.2.2. Input Ports Menu

When entering the menu, the available video input ports are listed. The icons display information about the port and the incoming signal (see the table below). Select the desired input port and enter to see the submenu.

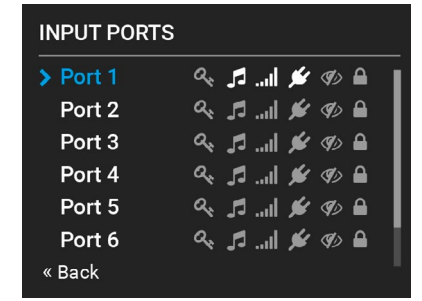

Icon	Icon is grey	Icon is white
	Signal is not encrypted with HDCP	Signal is encrypted with HDCP
	No audio signal in the video stream	Audio is embedded in the video stream
	Signal is not present	Signal is present
	Source is not connected	Source is connected
	The port is unmuted	The port is muted
	The port is unlocked	The port is locked

DisplayPort Status Submenu (Input)

DIFFERENCE: This submenu appears only when the selected port is DisplayPort. See the [Model Comparison](#) table on which model has DP input.

The most important properties of the incoming signal can be checked in this submenu:

Link Status

- 5V present
- Signal present
- Signal type
- Bandwidth
- Lane counts
- HDCP

Video Status

- Resolution
- Color depth
- Color space

Embedded audio status

- Audio type
- Sampling frequency

Advanced

- Pixel clock
- Total resolution

PORT 1 STATUS	
Link Status	
• 5V present	present
Signal present	present
Signal type	DP
Bandwidth	HBR2
Lane counts	4
« Back	

DisplayPort Settings Submenu (Input)

DIFFERENCE: This submenu appears only when the selected port is DisplayPort. See the [Model Comparison](#) table on which model has DP input.

HDCP *#hdcp*

The encryption towards the source can be set as follows:

- **Disable HDCP on input:** The connected source will detect that the sink is not HDCP-compliant and turn off authentication if the content allows it.
- **HDCP 1.4 only:** The signal is encrypted with HDCP v1.4
- **Allow HDCP 2.2 or HDCP 1.4:** The connected source will detect that the sink is compliant with HDCP 2.2 (factory default setting).
- **High Value mode:** If the highest level of protection is not justified by the source content, the level may be decreased. (e.g. the signal is encrypted with HDCP 2.2, but can be converted to be encrypted with HDCP v1.4)

See more information about HDCP in the [HDCP Management](#) section.

Other Settings

- **Max Lane Count** (1, 2, 4): One lane is able to transmit 5.4 Gbps data and four lanes are available (a maximum of 21.6 Gbps data rate). The maximum number of lanes can be set here.
- **Max Bandwidth** (RBR, HBR, HBR2): This defines the data speed per lane: RBR uses 1.62Gbps; HBR uses 2.70 Gbps; HBR2 uses 5.40 Gbps.
- **Power enable** (enable / disable): DisplayPort can supply 1.5 W (500 mA, 3.3V) towards the source.
- **Testpattern** (off / on): When the testpattern is enabled, it sends a yellow picture to the output (independently of the active video signal on the selected port). *#nosyncscreen #testpattern*

TIPS AND TRICKS: Enabling the testpattern makes it possible to transmit the analog audio without any active video signal on the DP input port beside it (only in the **-A** or **-Audio** suffixed models).

- **Conversion** (Off / RGB to YUV422 / RGB to YUV420):

Off means that the video signal is transmitted without changing anything; in case of **YUV422**, the video converter subsamples the 4:4:4 signal to 4:2:2; **YUV420** means that the video converter subsamples the 4:4:4 signal to 4:2:0. *#colorspace*

- **Audio source** (Disable / Video / Analog input *): The de-embedded audio can be turned on and off. *#audio #analogaudio #volume #balance #gain*

* Analog input option appears when there is an analog audio input beside the chosen video port. **-A** or **-Audio** suffix in the model name refers to the analog audio feature.

HDMI Status Submenu (Input)**Link Status**

- 5V present
- Signal present
- Signal type
- Bandwidth
- HDCP

Video Status

- Resolution
- Color depth
- Color space

PORT 13 STATUS	
Link Status	
• 5V present	present
Signal present	present
Signal type	HDMI
Bandwidth	4.45 Gbps
HDCP	no HDCP
« Back	

Embedded audio status

- Audio type
- Sampling frequency

Advanced

- Pixel clock
- Total resolution
- Scrambling

HDMI Settings Submenu (Input)

HDCP #hdcp

The encryption towards the source can be set as follows:

- **Disable HDCP on input:** The connected source will detect that the sink is not HDCP-compliant and turn off authentication if the content allows it.
- **Allow HDCP 1.4 only *:** The connected source will detect that the matrix is compliant with HDCP 1.4 but not compliant with HDCP 2.2.
- **Allow HDCP 2.2 or HDCP 1.4:** The connected source will detect that the sink is compliant with HDCP 2.2 (factory default setting).
- **High Value mode:** Any version of HDCP is allowed on the input but the incoming signal is converted to HDCP 2.2 level encryption, thus, it cannot be switched to HDCP 1.4 sinks.

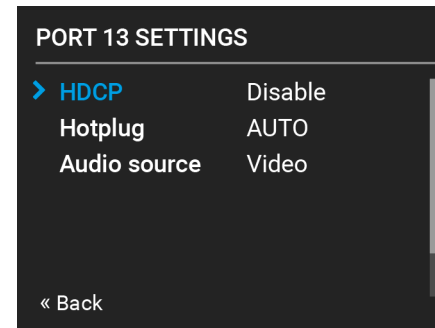

See more information about HDCP in the [HDCP Management](#) section.

*The availability of this setting depends on the hardware version of the input board (V1x_) only in MX2-8x8-HDMI20 model. The hardware version can be found in the [Status Tab](#) in the LDC or in the [System Settings Menu](#), [Device Info](#) submenu in the LCD.

Hotplug

The hotplug signal towards the source can be set to **Auto** or **Forced Off**.

Audio Source

The source of the embedded audio can be set in this menu:

Disable/ Video /Analog input *

* Analog option appears when there is an analog audio input beside the chosen video port. **-A** or **-Audio** suffix in the model name refers to the analog audio feature.

Analog Audio Submenu

DIFFERENCE: Analog Audio submenu appears when there is an analog audio input beside the chosen video port. **-A** or **-Audio** suffix in the model name refers to the analog audio feature (see the [Model Comparison](#) table about the analog audio availability).

Information about the Analog Audio input and the (HDMI) embedded audio signal is displayed in this submenu.

- **Audio Source:** Disable/ Video/ Analog Input
- **Audio Gain:** adjustable from -12 dB to +35 dB,
- **Analog Volume:** adjustable from 0 (-95dB) to 100% (0dB),
- **Analog Balance:** adjustable from -100 % (Left) to + 100% (Right), 0 means the center.

#audio #analogaudio #volume #balance #gain

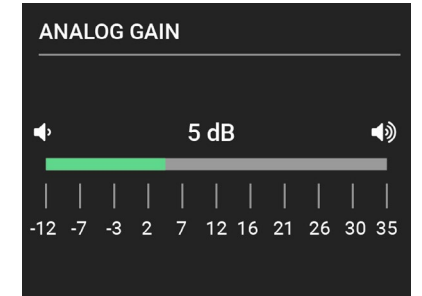

3.2.3. Output Ports Menu

When entering the menu, the available video output ports are listed. The icons display information about the port and the outgoing signal (see the table below). Select the desired output port and enter to see the submenu.

Icon	Icon is grey	Icon is white
	Signal is not encrypted with HDCP	Signal is encrypted with HDCP
	No audio signal in the video stream	Audio is embedded in the video stream
	Signal is not present	Signal is present
	Sink is not connected	Sink is connected
	The port is unmuted	The port is muted
	The port is unlocked	The port is locked

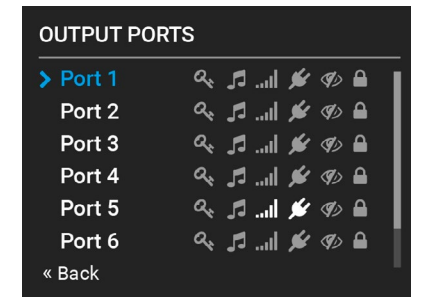

Displayport Status Submenu (Output)

The most important properties of the outgoing signal can be checked in this submenu:

Link Status

- HPD present
- Signal present
- Signal type
- Bandwidth
- Lane counts
- HDCP

Video Status

- Resolution
- Color depth
- Color space

Embedded audio status

- Audio type
- Sampling frequency

Advanced

- Pixel clock
- Total resolution

DP Settings Submenu (Output)

- **Power enable:** DisplayPort is able to provide 1.5 W (500 mA @ 3.3V) power towards the sink. For more details about it, see the [DisplayPort Output Settings](#) section.

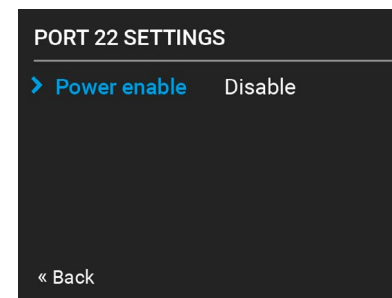
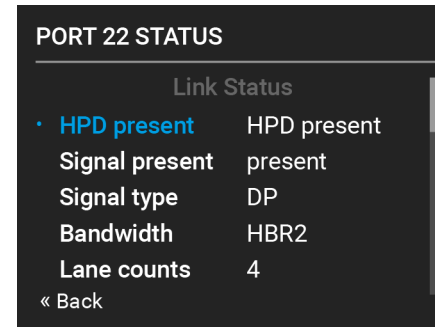

HDMI Status Submenu (Output)

The most important properties of the outgoing signal can be checked in this submenu:

Link Status

- HPD present
- Signal present
- Signal type
- Bandwidth
- HDCP

Video Status

- Resolution
- Color depth
- Color space

Embedded audio status

- Audio type
- Sampling frequency

Advanced

- Pixel clock
- Total resolution
- Scrambling

HDMI Settings Submenu (Output)

DIFFERENCE: Only the MX2-8X8-HDMI20-AUDIO-L model is able the **4:4:4 to 4:2:0 conversion** and the split function. The availability of this setting depends on the hardware version of the output board (V1x_), only in the MX2-8x8-HDMI20 model. The hardware version can be found in the [Status Tab](#) in the LDC or in the [System Settings Menu, Device Info](#) submenu in the LCD.

Conversion #colorspace

DIFFERENCE: The availability of **4:4:4 to 4:2:2 conversion** depends on the hardware version of the output board (V2x_). The matrix switcher accepts video signals in 8, 10 and 12 bit color depth, but the sampling pattern conversion is always made in 8 bit. The hardware version can be checked in the [Status Tab](#) in the LDC or in the [System Settings Menu, Device Info](#) submenu in the LCD.

The outgoing signal can be routed to the outputs with or without conversion as follows:

- **Passthrough:** no signal conversion.
- **4:4:4 to 4:2:0:** the signal is converted to the indicated color depth (RGB to YUV).
- **4:4:4 to 4:2:2:** the signal is converted to the indicated color depth. This feature is supported in case of HDMI 2.0 signals.

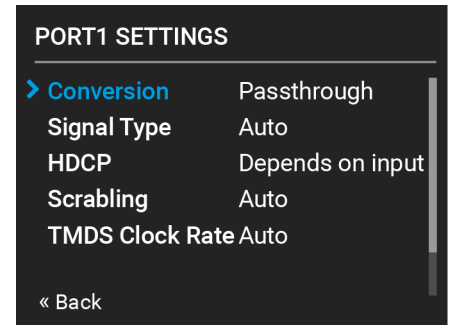
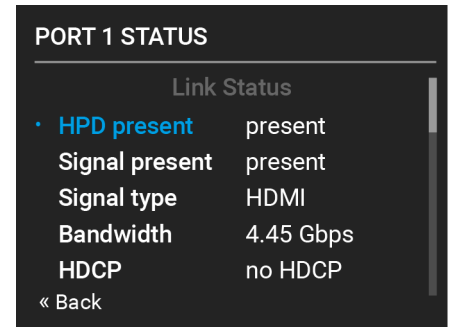

ATTENTION! 10 bit 4:4:4- video signal is converted to 12 bit 4:2:2.

- **Left part and Right part:** The device supports vertical splitting of an HDMI 2.0 4k@60Hz 4:4:4 input signal to left and right halves, allowing the transmission of an 18Gbps HDMI2.0 signal over two HDMI1.4 compliant links. The two halves can then be recombined at the signal destination. To apply the feature, route the same input signal to 2 output ports. Set the conversion to **Left part** on one output port and **Right part** on the other output port. See the [Typical Application](#) section.

Signal Type

- **Auto:** the outgoing signal format is set automatically according to the audio presence in the video stream: if audio is present, the signal format is HDMI.
- **HDMI:** the outgoing signal format is forced to be HDMI.
- **DVI:** the outgoing signal format is forced to be DVI.

HDCP #hdcp

- **Depends on input:** the encryption level is determined according to the settings on the input port and the source content/device. If the incoming signal is not encrypted, then the outgoing signal will not be encrypted either.
- **Max. possible:** the highest supported level of encryption (between the matrix and the sink) is applied (up to HDCP v2.2).

See more information about HDCP in the [HDCP Management](#) section.

Scrambling #scrambling

HDMI 2.0 standard introduced the **Scrambling** to the TMDS encoding, which helps to decrease the energy peaks and hence, the Electro Magnetic Interference (EMI). To maintain backward compatibility, HDMI 2.0 only requires the use of scrambling with data rates of above 3.4 Gbps per lane. The feature can be set on the output ports to **Auto** / **Forced On** / **Forced Off**.

INFO: The **Auto** setting (recommended) allows the pseudo-random conversion at frequencies above the threshold. **Forced on** and **Forced off** settings override this operation.

TMDS Clock Rate

However, the clock rate can be set to **1/10** or **1/40** if necessary, using the **Auto** setting is recommended.

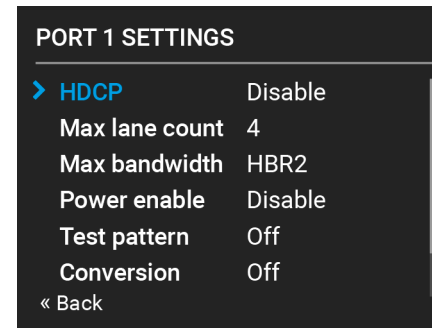

Analog Audio Submenu

DIFFERENCE: Analog Audio submenu appears when there is an analog audio output beside the chosen video port. **-A** or **-Audio** suffix in the model name refers to the analog audio feature (see the [Model Comparison](#) table about the analog audio availability).

Information about the Analog and the Embedded Audio signal are displayed in this submenu.

- **Audio Present** and **Audio Type** (signal info),
- **Audio Mode:** Off / DP or HDMI Only / Analog Only / DP or HDMI and Analog.
- **Analog Mute**
- **Analog Volume:** adjustable from 0 (-96dB) to 100% (0dB),
- **Analog Balance:** adjustable from -100% to + 100% (0 = center).

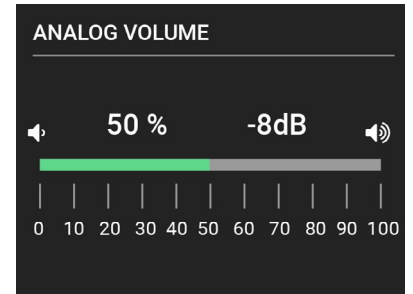

3.2.4. EDID Menu

Advanced EDID Management is available in the front panel LCD menu, which allows to view an EDID, switch, or save it to the User EDID memory. See more information about EDID technology in [EDID Management](#). The EDID memory structure of the device can be found in the [Sources and Destinations](#) section.

View Submenu #edid

Select the desired EDID memory block: **Factory EDIDs**, **Last Attached EDIDs**, **User EDIDs**, or **Emulated EDIDs**. Select the **Name** item and press the knob. Use the jog dial to step between the EDIDs. The following information can be checked:

- **Preferred Resolution**
- **Monitor Name**
- **Audio Info**

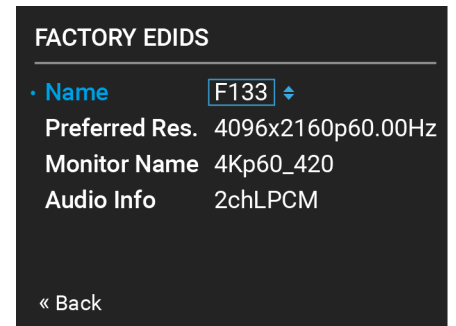

Switch Submenu *#edid*

The submenu looks similar to the View submenu, but in this case the Destination is also listed. To change an EDID, do the following:

Step 1. Navigate to the **EDID/Switch** submenu.

Step 2. Select the **Name** item and press the knob. Use the jog dial to select the desired **EDID** (F1-F144, U1-U100, or D1-D8) and press the knob.

Step 3. Select the **Destination** item and press the knob. Use the jog dial to select the desired **EDID memory** (E1-E8, All) and press the knob.

Step 4. Navigate to the **Switch** option and press the knob.

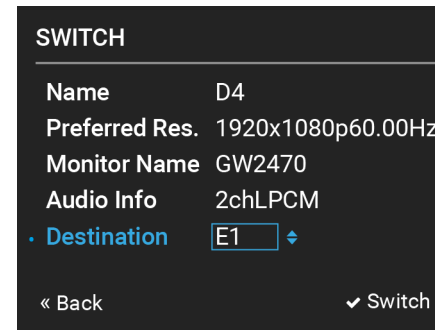

Save Submenu *#edid*

The EDID of a connected sink can be saved to the User EDID memory as follows:

Step 1. Navigate to the **EDID/Save** submenu.

Step 2. Select the **Name** item and press the knob. Use the jog dial to select the desired **EDID** (D1-D8) and press the knob.

Step 3. Select the **Destination** item and press the knob. Use the jog dial to select the desired **EDID memory** (U1-U100) and press the knob.

Step 4. Navigate to the **Save** option and press the knob.

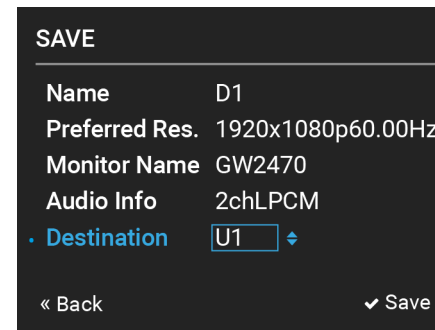

3.2.5. Health Menu

The following information is displayed about the matrix in this menu:

- **Uptime:** the elapsed time since the last booting.
- **Control Panel:** Internal Voltage and temperature values about the front panel board.
- **Motherboard:** Internal Voltage and temperature values about the motherboard.
- **IO ports:** Internal Voltage and temperature values about the Input/Output ports.

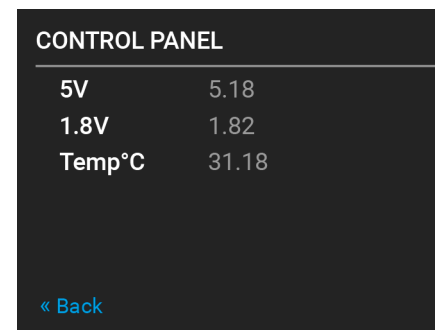

3.2.6. Presets Menu

The router can store presets, and the following are stored in each slot: Input/output crosspoint state, muted/unmuted states.

ATTENTION! When factory default settings are restored, presets are deleted. *#preset*

Load a Preset

ATTENTION! The Preset loading has an effect on all ports, except the locked ones.

Step 1. Navigate to the **Presets / Load Preset** submenu and press the knob.

Step 2. The previously saved presets are listed. Button1..8 mean the presets, which are also available by the front panel **Source buttons**. Select the desired **memory slot** and press the knob. If any other preset had been saved previously, they would be also listed.

Step 3. Confirm your selection by pressing the **Yes**.

INFO: Eight memory slots are available by the front panel buttons, see the [Save or Load a Preset](#) section.

Save a Preset

Step 1. Create the desired I/O layout.

Step 2. Navigate to the **Presets / Save Preset** submenu and press the knob.

Step 3. Select the desired **memory slot** (Button1..Button8 mean the eight **Source buttons**) and press the knob. If any other preset had been saved previously, they would be also listed. See the corresponding [Presets](#) section.

Step 4. Confirm your selection by pressing **Yes**.

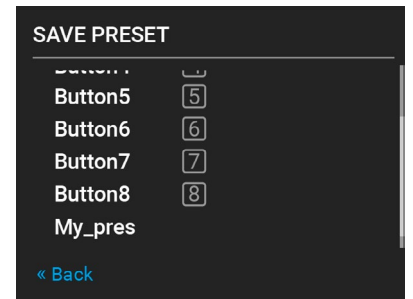

4

Installation

This chapter is about the installation of the device and connecting to other appliances, presenting also the mounting options and further assembly steps.

- ▶ [MOUNTING OPTIONS](#)
- ▶ [ELECTRICAL CONNECTIONS](#)
- ▶ [CONNECTING STEPS](#)

4.1. Mounting Options

The matrix can be mounted in several ways by the supplied two rack ears. Allen head screws fix them to the housing:

WARNING! M4x8 size is the longest allowed screw for fixing the ears to the housing. A longer screw may touch internal parts.

INFO: The method is the same when the matrix would be mounted to a wall.

INFO: More details about the accessories and the mounting can be found in the [Mounting Assembly Guide](#).

Standard Rack Installation (Default)

INFO: All models can be mounted into the rack cabinet.

Two rack ears are supplied with the product, which are fixed on left and right side as shown in the picture. The default position allows the mounting of the device as a standard rack unit installation.

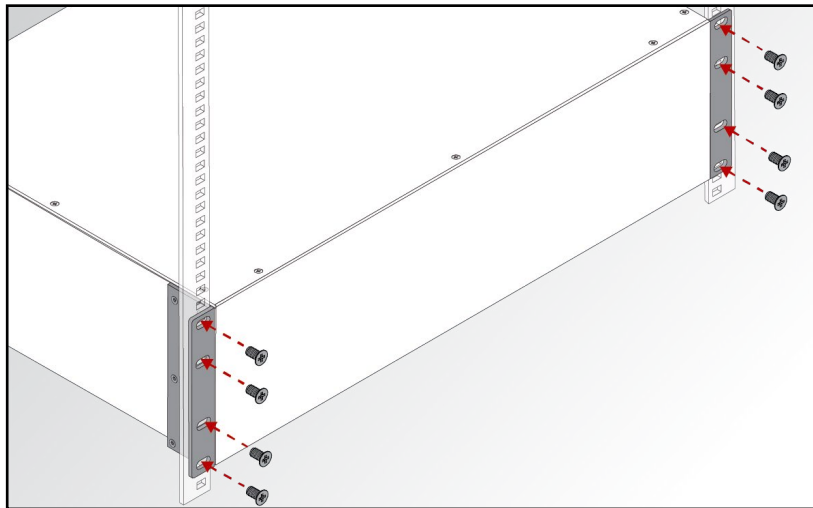

ATTENTION! Always use all four screws for fixing the rack shelf ears to the rack rail. Choose properly sized screws for mounting. Keep a minimum of two threads left after the nut screw.

Mounting with Front and Rear Rack Ears

DIFFERENCE: Under-desk mounting is available for the 1U-high models.

ATTENTION! Two rack ears are assembled on the matrix as default, thus you will need two more rack ears for this kind of installation, which can be purchased separately.

The matrix can be easily mounted under the desk by rack ears. This mounting option means **the top of the matrix is parallel with the base surface**. Please do the following steps:

Step 1. Release and remove the fixing screws of the rack ears on the matrix (both sides).

Step 2. Rotate the rack ears by 90° to the desired direction.

Step 3. Insert the screws into the holes and fix the front ears to the matrix.

Step 4. Fix the two additional rear ears (not supplied with the product) by the screws on both sides of the matrix.

Step 5. Fix the matrix through the holes of the rack ears to the desired surface (screws are not supplied).

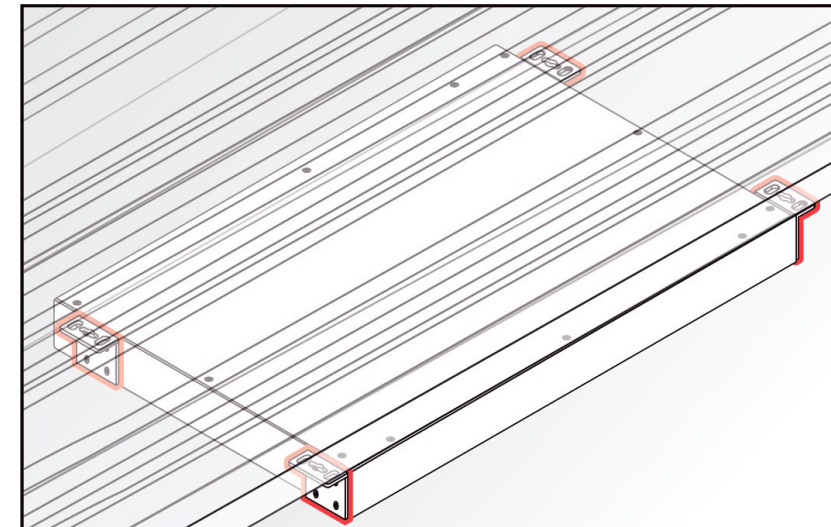

Fixing the Handles

DIFFERENCE: The handles are available for MX2-32x32-HDMI20-A-R, MX2-32x32-DH-16DPi-A-R, and MX2-48x48-HDMI20-A-R models.

Two handles can be mounted on the rack ears of the matrix. Fasten the 2 x 2 pcs of fixing screws to fix the handles to the rack ears.

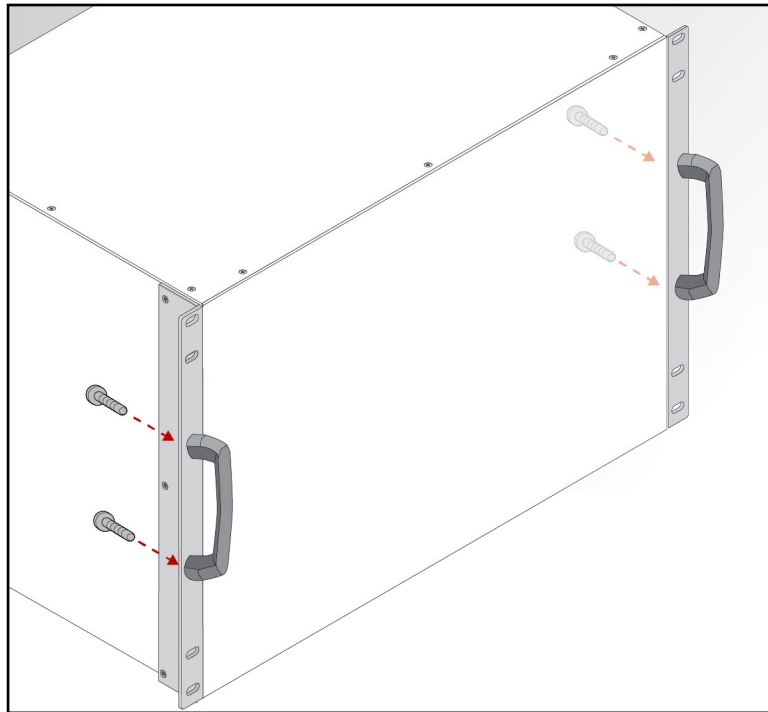

4.2. Electrical Connections

4.2.1. HDMI Connector

The matrix switchers are assembled with standard 19-pole HDMI connector for input or output. The outputs are able to supply 500 mA current on DDC +5V output (pin 18) which is sufficient to supply power to certain devices (e.g. DA2-HDMI-4K-Plus-A).



4.2.2. DisplayPort Connector

DIFFERENCE: Certain models provide standard 20-pole DisplayPort connector for input or output. See the details in the [Model Comparison](#) table.

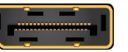

ATTENTION! The DisplayPort output ports cannot transmit embedded audio stream with more than 2 channels due to a bandwidth limitation. Accepted audio signals are 2-channel PCM between 48 and 192 kHz.

DisplayPort ports are capable of providing about 1.5 W (500 mA @ 3.3V) power on the DP_PWR pin. Always use high quality DP cable for connecting DisplayPort devices!

4.2.3. Symmetrical Analog Stereo Audio

DIFFERENCE: Certain models use this connector as an analog audio input or output. See the details about it in the [Model Comparison](#) table.

5-pole Phoenix connector is used for balanced analog audio (line in/out). Unbalanced audio signals can be connected as well. For asymmetrical output, connect only + and ground. For asymmetrical input connect + and ground to the source and connect - to the ground.



Pin nr.	Signal
1	Left+
2	Left-
3	Ground
4	Right-
5	Right+

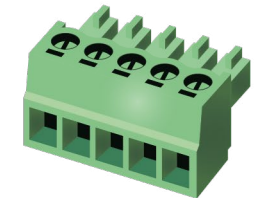

Compatible Plug Type

Phoenix® Combicon series (3.5mm pitch), type: MC 1.5/5-ST-3.5.

See more information about the most common audio cable wiring modes in the [Cable Wiring Guide](#) section.

4.2.4. RS-232 Port

3-pole Phoenix Connector

DIFFERENCE: Certain models are supplied with 3-pole Phoenix connector for RS-232 communication.

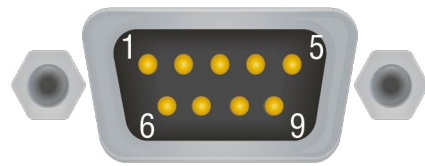

Pin nr.	Signal
1	NC (not connected)
2	RX data receive (input)
3	TX data transmit (output)
4	DTR (internally connected to pin6)
5	GND signal ground (shield)
6	DSR (internally connected to pin4)
7	RTS (internally connected to pin8)
8	CTS (internally connected to pin7)
9	NC (not connected)

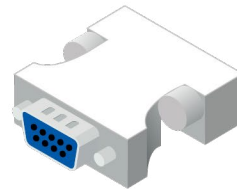

Compatible Plug Type

Phoenix® Combicon series (3.5mm pitch, 3-pole), type: MC 1.5/3-ST-3.5.

D-SUB Connector

DIFFERENCE: The -R suffixed models have female D-SUB connector for RS-232 data communication.

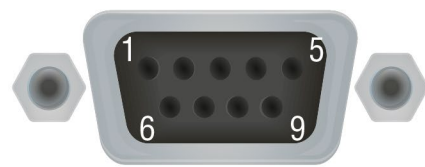

Pin nr.	Signal
1	NC (not connected)
2	RX data receive (input)
3	TX data transmit (output)
4	DTR (internally connected to pin6)
5	GND signal ground (shield)
6	DSR (internally connected to pin4)
7	RTS (internally connected to pin8)
8	CTS (internally connected to pin7)
9	NC (not connected)

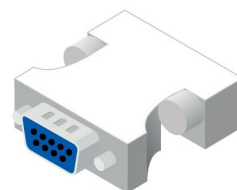

INFO: MX2-HDMI20 series matrix switchers are DCE units according to their pin-out. For more information, see the [Serial Management](#) section.

Factory default settings of the serial port: RS-232 enabled; 57600 Baud, Protocol: LW3.

4.2.5. Ethernet (LAN) Port

The matrix can be controlled by Ethernet/LAN connection. The Ethernet port can be connected to a LAN hub, switch or router by a CATx cable. While both cable types (straight or cross) are supported and handled by the device, the pin assingment below is recommended.

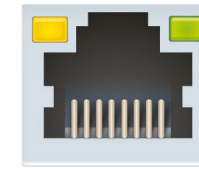

Pin	TIA/EIA T568A	TIA/EIA T568B
1	white/green	white/orange
2	green	orange
3	white/orange	white/green
4	blue	blue
5	white/blue	white/blue
6	orange	green
7	white/brown	white/brown
8	brown	brown

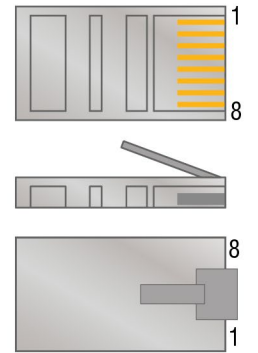

RJ-45 Connector

DIFFERENCE: Certain models are supplied with RJ45 connector for Ethernet communication. See the details in the [Model Comparison](#) table.

	LED 1, Amber	LED 2, Green
OFF	10 Mbps	No link
Blinking	N/A	Activity
ON	100 Mbps	Link is active

Neutrik EtherCON Connector

DIFFERENCE: The -R suffixed models have EtherCON connector for Ethernet communication.

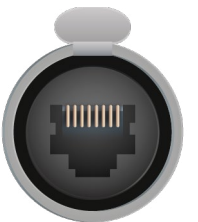

4.2.6. USB Connector

MX2-HDMI20 series matrix switchers have standard USB mini-B receptacle.



4.3. Connecting Steps

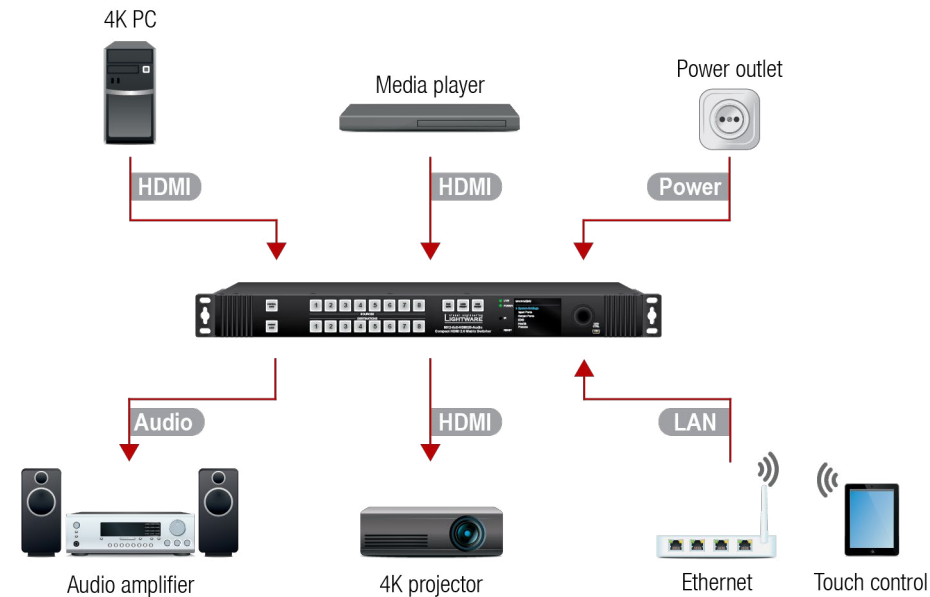

- HDMI** Connect the desired sources to the **HDMI input ports**. Always use high-quality HDMI cables. Maximum cable lengths for inputs: 1920x1080@60Hz 4:4:4 - 40m; 3840x2160@30Hz 4:4:4 - 15m; 3840x2160@60Hz 4:4:4 - 5m
- Audio** Optionally connect an audio source to the **Audio input port**, which is located next to the connected HDMI input port.
- HDMI** Connect the sink devices to the **HDMI output ports**.
- Audio** Optionally connect an audio device (e.g. audio amplifier) to the **Phoenix Audio output port**, which is located next to the connected HDMI output port.
- LAN** In order to control the matrix via Ethernet, connect the device to a LAN switch/router, and connect a controller (e.g. a Touch panel).
- Power** Connect the power cord to the AC power socket, and to the matrix.

4.3.1. Powering On

Connect the power cords to the AC input of the Power Supply Units (PSU).

INFO: The router has an internal emergency memory that stores all current settings and tie configurations. This memory is independent from presets and invisible for the user. This built-in feature helps the system to be ready immediately in case of a power failure or an accidental power down.

1 RU-high models

The 1 RU-high models are immediately powered on. After the self-test (about 20 seconds), the router reloads its last configuration and it is ready to use.



Other models

Certain models are assembled with a power button (see the details in the [Model Comparison](#) table).

After switching the power switch to the **ON** position, the router starts up. If the mains' switch is in the **ON** position, then the matrix starts up immediately when the power cord is connected to the AC source. During the initial self-test and loading of the latest settings, **The matrix is about to start** appears on the LCD screen and the router reloads its last configuration.



INFO: After switching ON, the router reloads the latest settings that were used before it was switched off. The router has an internal emergency memory that stores all current settings and tie configurations.

Redundant Power Supplies

The **-R** suffix in the model name shows that the model has redundant PSUs, which can be switched on and off without interrupting the video transmission. Using only one or both the PSUs at the same time is also possible.

Double PSU allows connection to two different AC power lines to ensure the continuous power for the matrix.



5

Device Concept

The following chapter describes the features of the device with a few real-life examples.

- ▶ [PORT DIAGRAM](#)
- ▶ [HDMI VIDEO OPTIONS](#)
- ▶ [DISPLAYPORT VIDEO OPTIONS](#)
- ▶ [ANALOG AUDIO OPTIONS](#)

5.1. Port Diagram

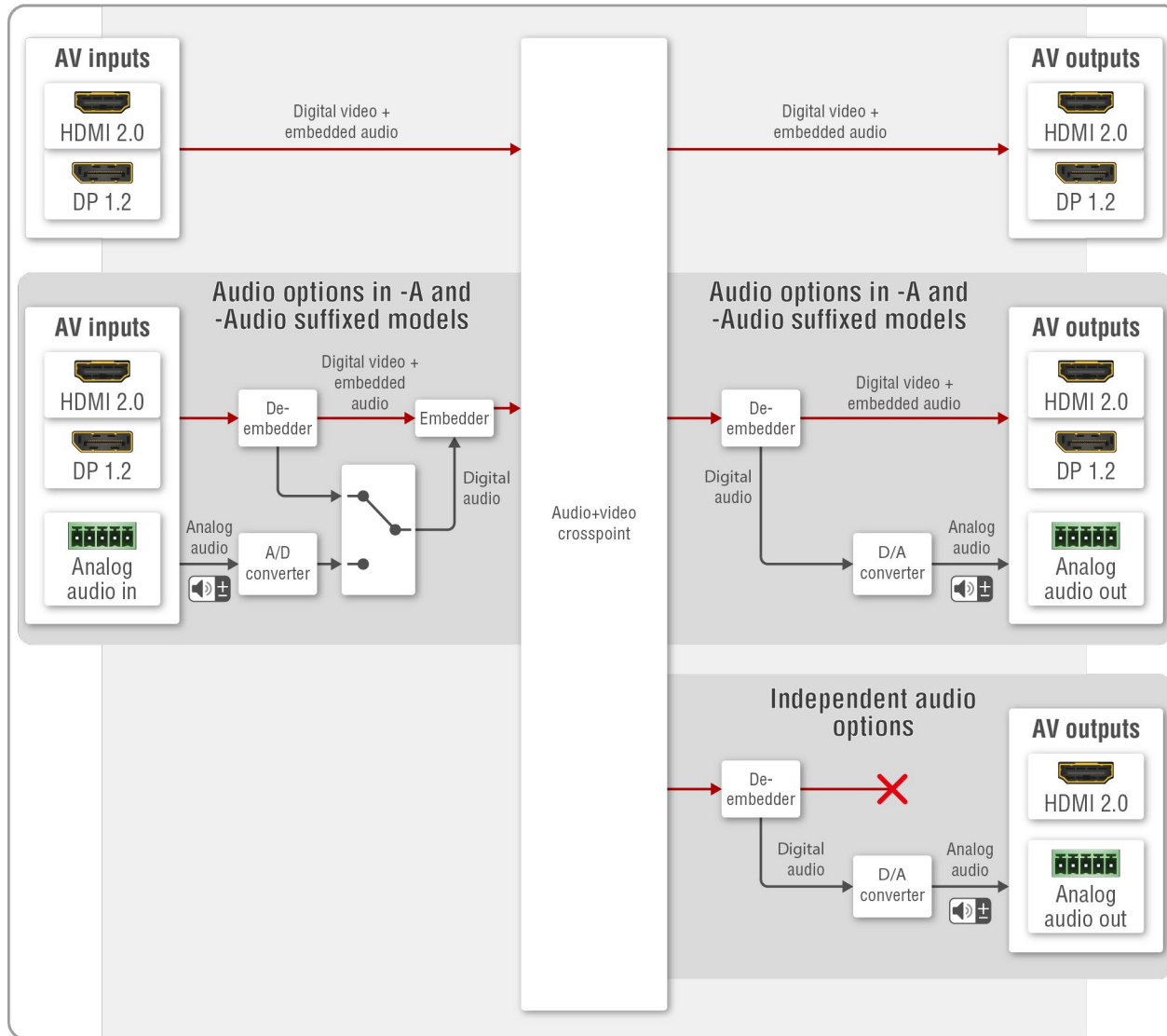

AV port diagram for the MX2 standalone matrix switcher series

ATTENTION! Please note there is no independent audio layer in the matrix. It means the same embedded audio can be switched to a HDMI/DP video port and an Analog audio output port when switching an AV stream in the crosspoint.

ATTENTION! If you select an **Independent audio output** as an audio destination, the embedded audio and the video signal is switched together to the related HDMI and Independent audio output port and in this case the HDMI output port **does not transmit AV signal**.

5.2. HDMI Video Options

ATTENTION! The matrix switcher accepts video signals in 8, 10 and 12 bit color depth, but the sampling pattern conversion is always made in 8 bit with the result of 12 bit.

Color Space	HDMI Input		Output color conversion	Color Space	HDMI OUT			
	Sampling method	Color depth			Sampling method	Color depth		
YCbCr	4:4:4	8	4:4:4 to 4:2:2	YCbCr	4:2:2	12		
		10				12		
		12				12		
		16				12		
RGB	4:4:4	8		4:4:4 to 4:2:2		RGB	4:2:2	12
		10						12
		12						12
		16						12

DIFFERENCE: Only the MX2-8X8-HDMI20-AUDIO-L model is capable of the **4:4:4 to 4:2:0 conversion** and the split function. The availability of this setting depends on the hardware version of the output board (V1x_), only in the MX2-8x8-HDMI20 model. **4:4:4 to 4:2:2 conversion** is available from V2x_ hardware version of the output board. The hardware version can be checked in the [Status Tab](#) in the LDC or in the [System Settings Menu, Device Info](#) submenu in the LCD.

5.3. DisplayPort Video Options

DIFFERENCE: DisplayPort inputs are available in certain models, **-D** letter in the model name refers to that (see the [Model Comparison](#) table).

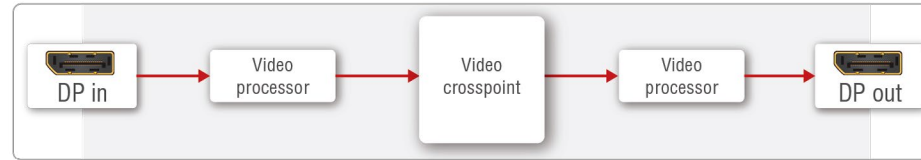

Port Diagram of the Displayport input and Displayport output matrix

- If the emulated EDID does not support the deep color signal (10, 12-bit), and the incoming video is deep colored, then the video processor converts the signal to 8-bit automatically. The compatible color depths can be checked in the [EDID Menu](#) in [Software Control - Lightware Device Controller](#) software.
- The factory default EDID (F49 - 1920x1080p60.00Hz) has deep color support up to the full HD resolution. When the resolution of the incoming video signal is more than the full HD with deep color (e.g. 4K@30Hz with 10-bit or 12-bit), the color depth is reduced to 8-bit.
- If the signal is 4K@30Hz with 10-bit or 12-bit, using F146 EDID (3840x2160@60Hz with deep color support) is highly recommended.
- DisplayPort signals over 18Gbps will be converted down by either truncating bit depth or by converting RGB signal to YCbCr 4:2:2 12-bit signal based on user selection. The second option will not reduce the color depth, instead it results in loss of chroma information.
- The video processor converts the DisplayPort video signal to HDMI in all models.

5.3.1. Color Conversion

The table below gives an overview about the automatic color conversion of the video signal. This conversion happens without any user intervention, in color conversion setting (4:4:4 to 4:2:2); in the DP output port this is not available.

Color Space	HDMI Input		Color conversion	DP Output	
	Sampling method	Color depth		Sampling method	Color depth
YCbCr	4:4:4	8	→	4:4:4	8
		10	→		10
		12	↻		10
		16	↻		10
	4:2:2	8	→	4:2:2	8
		10	↻		8
		12	↻		8
		16	↻		8
	4:2:0	8	→	4:4:4	8
		10	→		10
		12	↻		10
		16	↻		10
RGB	8	→		8	
	10	→		10	
	12	↻		10	
	16	↻		10	

→ No color conversion

↻ Color conversion

5.3.2. Limitations of the DisplayPort Video Options

- DP Multi-Stream (MST) is not supported.
- The matrix is recognized as a DP-to-HDMI converter by the connected DisplayPort source.
- The video input signal of 3840x2160 4:4:4 RGB 10 bit is converted to 3840x2160 4:2:2 YCbCr 10 bit or 3840x2160 4:4:4 RGB 8 bit on the DisplayPort input.
- Dual-mode DisplayPort (DP++) is not supported.
- Adaptive-Sync and FreeSync™ are not supported.
- HDR is not supported on the DisplayPort outputs.

ATTENTION! The DisplayPort output ports cannot transmit embedded audio stream with more than 2 channels due to a bandwidth limitation. Accepted audio signals are 2-channel PCM between 48 and 192 kHz.

5.4. Analog Audio Options

DIFFERENCE: The -A suffix in the model name refers to the analog audio option (for more information about the models, see the [Model Comparison](#) table).

- An external audio signal can be embedded in the HDMI stream by the Analog Audio input port. In this case the audio from the analog input port is converted and embedded in the HDMI stream. Furthermore, the Analog audio output ports allow to de-embed the audio of the HDMI output stream. Please note that only stereo LPCM can be de-embedded from the HDMI signal.

The test pattern generator feature makes it possible to transmit the analog audio without any video signal.

6

Software Control - Using the Built-in Web

The built-in website of the matrix allows connection and control of the matrix via a web browser. Built-in web and Lightware Device Controller Software has the same look and functionality.

- ▶ [ESTABLISHING THE CONNECTION](#)
- ▶ [THE LAYOUT OF THE BUILT-IN WEB](#)

System Requirements #web #builtinweb

Operating System: Microsoft Windows XP, Windows Vista, Windows 7, Windows 10, macOS, Linux.

Web Browser: Mozilla Firefox, Google Chrome, Apple Safari.

ATTENTION! The EDID export function works only in Windows and macOS operating systems, under Mozilla Firefox or Google Chrome web browsers.

6.1. Establishing the Connection

ATTENTION! Please be sure that the computer is in the same network as the matrix. If the computer has multiple Ethernet connections (for example Wi-Fi and LAN connections are used simultaneously), you will have to know the IP address for the one that is used for controlling the matrix.

Step 1. Connect the matrix and the computer either via

- Ethernet, with LAN patch cable (to a Hub, Switch or Router), or
- Ethernet, with LAN cross cable (directly to Computer).

Step 2. Change to the desired IP settings if it is needed.

Step 3. Type the IP address to the address bar of the web browser and press enter (factory default address is dynamic).

6.2. The Layout of the Built-in Web

The built-in web page allows almost the same controlling functions that are available via the Lightware Device Controller. Select a menu item on the left side; the default screen is the Crosspoint menu with Grid view. One of the differences: the web page can be reloaded by clicking on the information ribbon.

ATTENTION! Please enable the pop-up windows in your browser; certain contents are displayed in a new window.



***Tile View of the Crosspoint Menu of the Built-in Webpage
(Displayed in a mobile device)***

7

Software Control - Lightware Device Controller

The matrix can be controlled by a computer through the LAN or USB ports using Lightware Device Controller (LDC). The software can be installed on a Windows PC or macOS. The application can be downloaded from www.lightware.com. The Windows and the Mac versions have the same look and functionality.

- ▶ INSTALL AND UPDATE
- ▶ RUNNING THE LDC
- ▶ DEVICE DISCOVERY WINDOW
- ▶ CROSSPOINT MENU
- ▶ INPUT PORT PROPERTIES
- ▶ OUTPUT PORT PROPERTIES
- ▶ PRESETS
- ▶ EDID MENU
- ▶ SETTINGS MENU
- ▶ ADVANCED VIEW

7.1. Install and Update

Minimum System Requirement

RAM: 1 GB

Minimum display resolution: 1280x720

Installation for Windows OS

Step 1. Run the installer. If the User Account Control drops a pop-up message, click **Yes**.

Step 2. During the installation you will be prompted to select the type of the installation: **normal** and the **snapshot** install:

Normal install	Snapshot install
Available for Windows and macOS	Available for Windows
The installer can update only this instance	Cannot be updated
Only one updateable instance can exist for all users	Different versions can be installed for all users

Comparison of the Installation Types

ATTENTION! Using the Normal install as the default value is highly recommended.

Installation for macOS

INFO: After the installation, the Windows and the Mac application has the same look and functionality. This type of the installer is equal with the Normal install in the case of Windows and results an updateable version with the same attributes.

Mount the DMG file by double clicking on it and drag the LDC icon over the Applications icon to copy the program into the Applications folder. If you want to copy the LDC into another location, just drag the icon over the desired folder.

ATTENTION! Please check the **firewall settings** on the macOS device. LDC needs to be added to the exceptions of the blocked software for the proper operation.

The Updating of the LDC

Step 1. Run the application.

The Device Discovery window appears automatically and the program checks the available updates on Lightware's website and opens the update window if LDC updates are found.

The current and the update version numbers can be seen at the top of the window, and they are shown in this window even with the snapshot install.

The **Update** window can be opened manually by clicking on the **question mark** and the **Update** button.

Step 2. Set the desired update setting in the **Options** section.

- When the **Check for updates automatically** option is marked, the LDC tries to find a new version after startup.
- If you want to postpone the update, set the reminder from the **drop down list**.
- If necessary, the proxy settings are available by clicking on the **Setup** button.

Step 3. Click the **Download update** button to start the updating.

Step 4. When the download process finished, the **Download Update** button changes to **Launch update**. Click on it to install the new version.

7.2. Running the LDC

The common way to start the software is to double-click on the LDC icon. But the LDC can be run by command line parameters as follows:

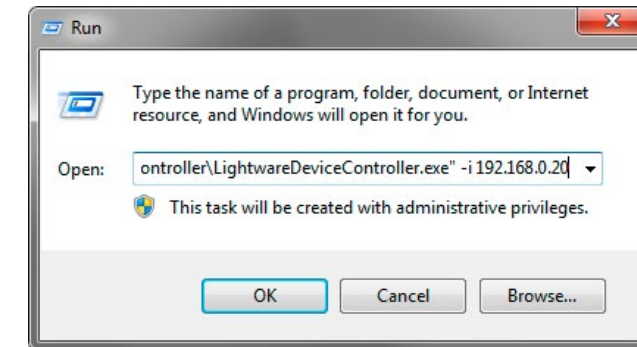

Launching of LDC in a Run window in Windows operating system

Connecting to a Device with Static IP Address

Format: LightwareDeviceController -i <IP_address>:<port>

Example: LightwareDeviceController -i 192.168.0.20:6107

The LDC is connected to a device with the indicated static IP address directly; the Device Discovery window is not displayed. When the port number is not set, the default port is used: 10001 (LW2 protocol). For LW3 devices, use the **6107** port number.

Adjusting the Zoom

The window can be zoomed to a specific value to fit to the resolution of the desktop (higher/lower). '1' is the default value (100%).

Format: LightwareDeviceController -z <magnifying_value>

Example: LightwareDeviceController -z 1.2

ATTENTION! The last set value is stored and applied when LDC is started without a parameter.

7.3. Device Discovery Window

There are three tabs for the different type of interfaces, select the Ethernet or USB tab.

The screenshot shows the 'Device Discovery' window with the 'Ethernet Devices' tab selected. It displays two lists of discovered devices.

Favorite Devices (fix IP)

N.	IP	Port	Product name	Device label	Local alias	Serial number
1	127.0.0.1	6107	MMX8x8-HDMI-4K-A	MMX8x8-HDMI-4K-A	EMULÁLT ESZKÖZ	00005482
2	192.168.0.110	6107	MX2-24x24-DH-12DP+R	MX2-24x24-DH-12DP+R	Add local alias	95144905
3	192.168.0.90	6107	MMX6x2-HT220	MMX6x2-HT220	Add local alias	00003326

All Devices (Devices found: 12)

IP	Port	Product name	Device label	Serial number
192.168.0.110	6107	MX2-24x24-DH-12DP+R	MX2-24x24-DH-12DP+R	95144905
192.168.4.117	6107	UBEX-MMU-X200	UBEX-MMU-X200	00005746
192.168.4.123	10001	N/A	N/A	N/A
192.168.4.131	6107	UBEX-PRO20-HDMI-F110	REMOTE	00005569
192.168.4.199	6107	UBEX-PRO20-HDMI-F110	PRIMARY	87654321
192.168.4.214	6107	MX2-4x4-HDMI20-CA	MX2-8X8-HDMI20-AUDIO	MX2regression
192.168.4.229	6107	UBEX-MMU-X200	UBEX-MMU-X200	00005475
192.168.4.236	6107	MX2-24x24-DH-12DP+A	FUKU	MX2regression
192.168.4.252	6107	UBEX-PRO20-HDMI-F100	UBEX-PRO20-HDMI-F100	7C110511
192.168.4.255	6107	UBEX-MMU-X200	UBEX-MMU-X200	86122867
192.168.4.83	6107	MMX4x2-HT200	MMX4x2-HT200	00005037

Device Discovery Window

The **Ethernet** tab consists of two lists:

- **Favorite Devices:** You can add any Lightware device that is connected via Ethernet, and there is no need to browse all the available devices. Devices can be added by pressing the **Add** button or marking the desired device by the ★ symbol in the **All Devices** list.
- **All Devices:** The Lightware devices are listed that are available in the connected network.

Establishing the Connection

Select the unit from the discovered Ethernet devices; double click on the device, or select it and click on the green **Connect** button.

Changing the IP Address

To modify IP address settings quickly, it is not necessary to enter the device's settings/network menu, you can set them by clicking the pencil icon next to the IP address.

You can see the new settings only in this window.

`#network #ipaddress #dhcp #mac`

Identifying the Device

Clicking on the icon makes the four front panel LEDs blink in green for 10 seconds. The feature helps to identify the device itself in the rack shelf. `#identifyme`

Import/Export the List of Favorite Devices

DIFFERENCE: This feature is available only from LDC version v2.5.5.

The list of favorite devices can be exported/imported with the dedicated buttons (saved as *.JSON file). The list can be imported later (in another computer, too), but please note that the current list will be overwritten by the imported list.

Further Tools

The **Tools** menu contains the following options:

- **Log Viewer:** The tool can be used for reviewing log files which have been saved previously.
- **Create EDID:** This tool opens the Easy EDID Creator wizard, which can be used for creating unique EDIDs in a few simple steps. Functionality is the same as the Easy EDID Creator; for the detailed information, see the [Creating an EDID](#) section.
- **Demo Mode:** This is a virtual MX-FR17 matrix router with full functionality built into the LDC. Functions and options are the same as a real MX-FR17 device.

The **Terminal** window is also available by pressing its button on the bottom.

7.4. Crosspoint Menu

7.4.1. Grid View

Grid view is a user-friendly graphical interface displaying the crosspoint state of the matrix router. This is an easy way to change between the input sources and output sinks. `#crosspoint #switch #gridview`

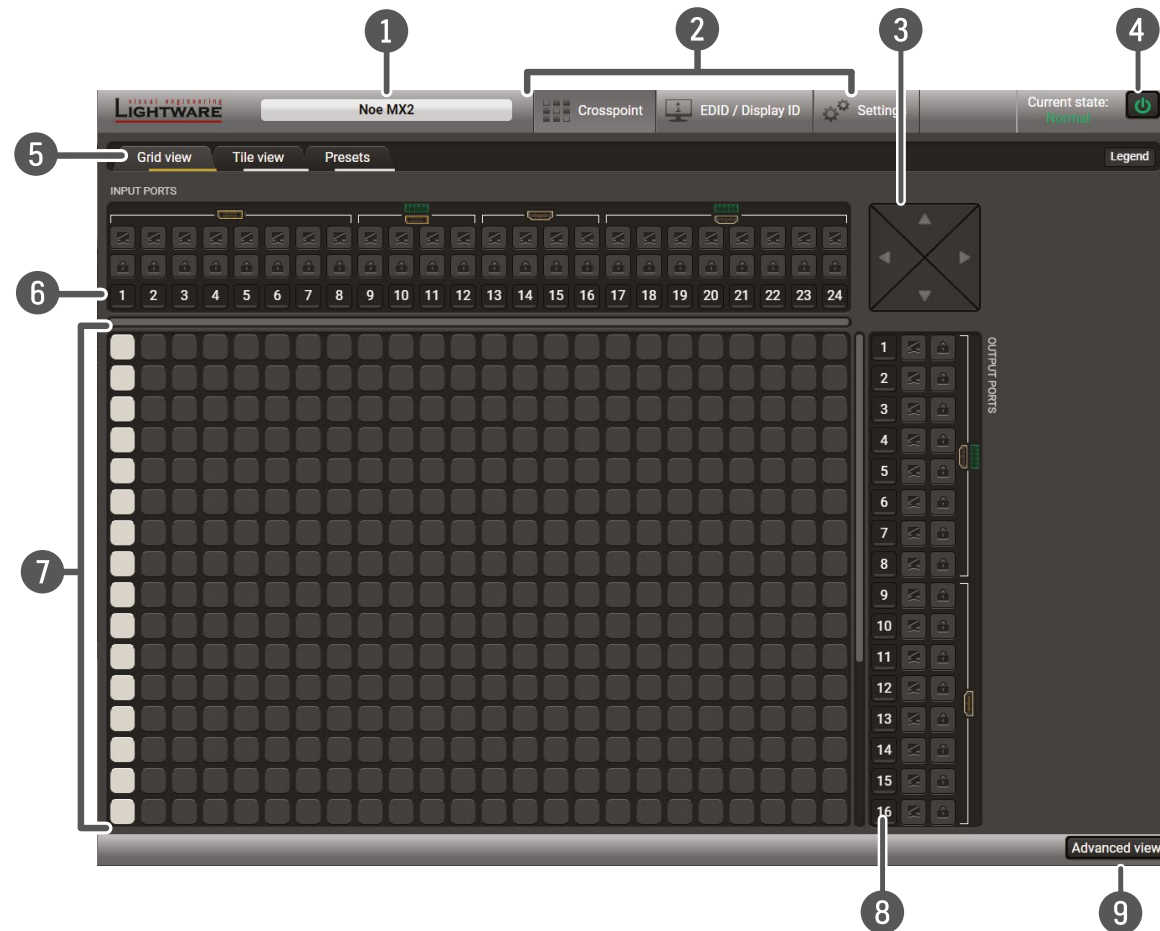

Crosspoint menu of the MX2-24x24-DH-12DPi-R model

- 1 Device Label** The **Device Discovery** window can be opened by clicking on this ribbon. The Device Label is displayed, which is not the same as the Product Name. The Product name is displayed in a hint box when the mouse cursor is above the box. See more information in the [Status Tab](#) section, and the [Setting the Device Label](#) section.
- 2 Main Menu** The available menu items are displayed. The active one is highlighted with a dark grey background color
- 3 Navigation Panel** When the matrix size is too big to display all inputs and outputs, click on the navigation bars that can be moved up and down or left and right to reach the other ports.
- 4 Standby Switch** The device can be switched to **Standby Mode** or wake up from this mode by the button. When the matrix is in standby mode, the video transmission is disabled and the LCD is switched off. Remote connections (LAN, RS-232) remain enabled.
- 5 Tab Selector Ribbon** Select the desired **Grid View**, **Tile View** or **Presets** tab.
- 6 Input Ports** Each number represents an input port. Click on the port to display the **Port Properties** window.
- 7 Connections** **Grey** square means the port is available, but there is no connection. **White** square means there is a connection between the input and the output port.
- 8 Output Ports** Each number represents an output port. Click on the port to display the **Port Properties** window.
- 9 Advanced View** Displaying the **Advanced view** page, showing the Terminal window and the LW3 protocol tree.

Crosspoint Operations

Switching

For making a connection, click on the desired square. If there is no connection between the desired input and output (the square is dark grey), the mouse pointer becomes a hand (link pointer) before the clicking. If the output port is not locked, the connection is made, the square becomes white and the cursor changes back to a pointer.

For example, Input 8 is not connected to Output 2 as shown on the first picture. If the connection is established, the square becomes white. Input and output ports can be disconnected when clicking on a white square.



Muting Outputs *#mute #unmute*

Outputs can be easily muted by clicking on the button represented by a crossed monitor beside the output. That means no signal is present on the given output. If mute is active, the color of the button’s background changes to white.



Locking Outputs *#lock #unlock*

Outputs can be locked to any input. After locking an output to an input, no switching is permitted to this output unless it is unlocked again. If output lock is active, the color of the button’s background changes to white.

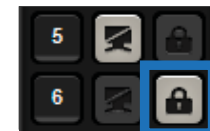

INFO: Loading a preset does not change either the lock state or the switch state of a locked output. If an output is locked to an input before preset loading, it will also be locked to that input after preset loading, so locked outputs ignore the preset.

7.4.2. Tile View

The tiles represent input or output ports and additionally show the most important port and signal information. Thus, the user can check the status of many ports at the same time. *#crosspoint #switch #tileview*

Control Buttons

	Mute or unmute selected output port(s)		Open port properties window
	Lock or unlock selected output port(s)		Select all ports (only in output switch mode)
	Activate View mode		Deselect all ports (only in output switch mode)
	Activate Input switch mode		Toggle Autotake mode ON/OFF
	Activate Output switch mode		Execute crosspoint changes in Take mode

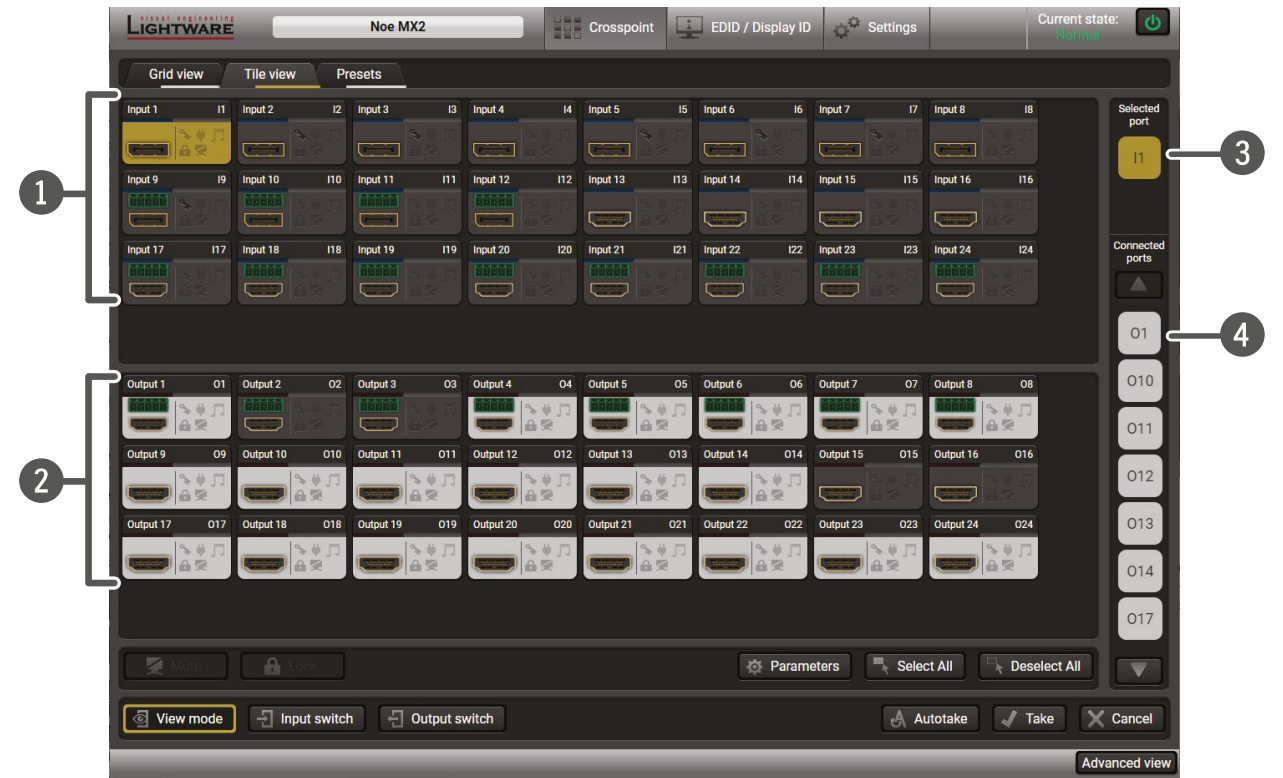

- 1 Input Ports** Each tile represents an input port.
- 2 Output Ports** Each tile represents an output port.
- 3 Selected Port** Last selected port is displayed with a yellow background on the port bar. Press the button to open the port settings window.
- 4 Connected Port(s)** The ports with white background are currently connected to the selected port. Press the button to open the port settings window.

Port Tiles

The colors of the port tiles and the displayed icons represent different states and information about the selected port:

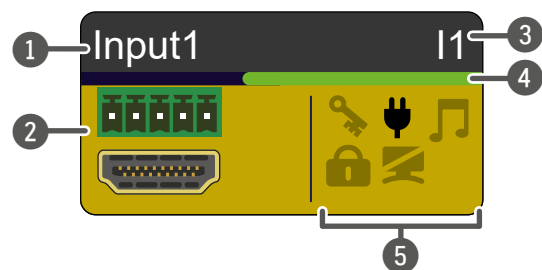

- 1 Port name
- 2 Background color:
 - grey: not connected
 - yellow: selected
 - white: connected
- 3 Port number
- 4 Signal present indicator
 - green: present
 - grey: not present
- 5 State indicators

State Indicators

Following icons display different states of the input/output ports/signal:

Icon	Icon is grey	Icon is black
	Signal is not encrypted with HDCP	Signal is encrypted with HDCP
	Source/sink is not connected	Source/sink is connected (+5V / Hotplug detected)
	Audio is not embedded in the video stream	Audio is embedded in the video stream
	Port is unlocked	Port is locked
	Port is unmuted	Port is muted

Display Modes

View Mode

This mode was designed to display the crosspoint state of a selected port and its connected port(s). Crosspoint settings cannot be changed in View mode, but port settings are available.



Input Switch Mode

The mode can also be named as 'Input priority-mode': an input port has to be selected at first, then the connected output ports are shown. Thus, the output ports connected to the input port can be changed.



Output Switch Mode

This mode can also be named as 'Output priority-mode': an output port has to be selected at first, then connected input port is shown. Thus, the output port connected to the input port can be changed.



Switching Operations

Take Mode

If the Autotake button is outlined with black color, Take mode is active. In Take mode any crosspoint change – (dis)connecting ports to/from the previously selected port – is executed only after pressing the Take button. The following steps describe the process of the switching:



- Step 1.** Press the desired **Input switch** or **Output switch** button to select the switching mode.
- Step 2.** Select the desired port; it will be highlighted with yellow color and displayed also on the port bar on the right.
- Step 3.** Connected ports are highlighted with white color and displayed also on the port bar on the right.
- Step 4.** Create the desired crosspoint settings by (de)selecting the ports; they will start to blink.
- Step 5.** Press the **Take** button to execute changes, or **Cancel** to discard.

INFO: Take mode remains active until it is switched off. Selecting another view mode or menu item does not change the Take/Autotake mode state.

Autotake Mode

If the Autotake button is outlined with yellow color, Autotake mode is active. In this mode, any crosspoint change – (dis)connecting ports to/from the previously selected port – is executed immediately after pressing the port button. The following steps describe the process of the switching:



- Step 1.** Press the desired **Input switch** or **Output switch** button to select switching mode.
- Step 2.** Select the desired port; it will be highlighted with yellow color and displayed also on the port bar on the right.
- Step 3.** Connected ports are highlighted with white color and displayed also on the port bar on the right.
- Step 4.** Create the desired crosspoint settings by (de)selecting the ports; the changes are executed immediately.

INFO: Autotake mode remains active until it is switched off. Selecting another view mode or menu item does not change the Take/Autotake mode state. `#take #autotake`

7.5. Input Port Properties

7.5.1. HDMI Inputs

Click on a port to display its properties; Signal status information and the most important parameters are displayed.

General Tab - General

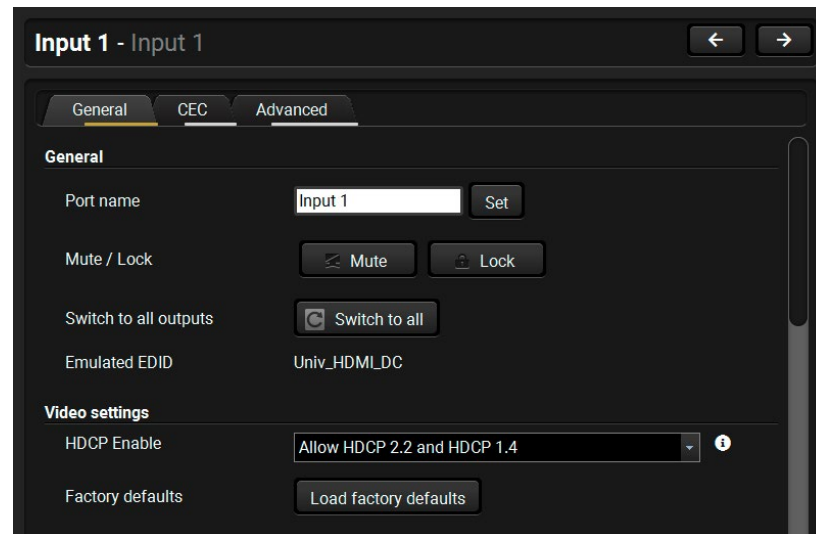

General tab in the input port properties window

Port name

The name of a port can be changed by typing the new name and clicking on the **Set** button. The following characters are allowed when naming: Letters (A-Z) and (a-z), hyphen (-), underscore (_), numbers (0-9), and dot (.). Max length: 63 characters.

Mute *#mute #unmute*

The incoming signal can be muted/unmuted by pressing the button. If the port is muted, button text is **Unmute**. In this case, no signal is transmitted from the input port.

Lock *#lock #unlock*

The port can be locked to the currently connected output ports by the button. If the port is locked, button text is **Unlock**. In this case the mute state and the crosspoint cannot be changed.

Switch to all

The input port will be switched to all output ports.

Emulated EDID

The name of the currently emulated EDID (displays the **Monitor Name** in the EDID menu).

General Tab - Video Settings

HDCP Enable *#hdcp*

- **Disable HDCP on input:** The connected source will detect that the matrix is not HDCP-compliant and turn off authentication if the content allows it.
- **Allow HDCP 1.4 only*:** The connected source will detect that the matrix is compliant with HDCP 1.4, but not compliant with HDCP 2.2.
- **Allow HDCP 2.2 and HDCP 1.4:** The connected source will detect that the matrix is compliant with HDCP 2.2.
- **High Value mode (limit switching to HDCP 2.2 sinks):** Any version of HDCP is allowed on the input, but the incoming signal is always internally upconverted to HDCP 2.2 content and thus cannot be switched to HDCP 1.4 sinks.

*The availability of this setting depends on the hardware version of the input board (V1x_) and the port type (HDMI), only in MX2-8x8-HDMI20 model. The hardware version can be found in the [Status Tab](#) in the LDC or in the [System Settings Menu, Device Info](#) submenu in the LCD.

Resetting the default values: **HDCP = HDCP 2.2 and HDCP 1.4.**

General Tab - Audio Settings

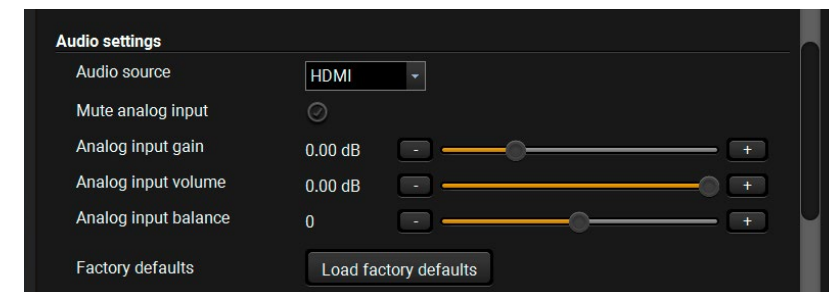

Analog audio settings in the output port properties window

Audio source *#audio #analogaudio*

- **Off:** audio is not embedded in the video stream.
- **HDMI:** the audio of the incoming video stream is embedded in the video.
- **Analog input :** the analog audio input signal is embedded in the video.

DIFFERENCE: Analog audio properties appear only in **-Audio or -A** suffixed models, where there is an analog audio port beside the video port.

Mute analog input

The analog audio input signal can be muted by this option.

Analog input gain

Setting the value between -12 dB and +35 dB.

Analog input volume

Setting the value between -95.62 dB and 0 dB.

Analog input balance

Setting the value between -100 and +100 (0 = center).

Video status

The signal format and the detected parameters are described in these sections.

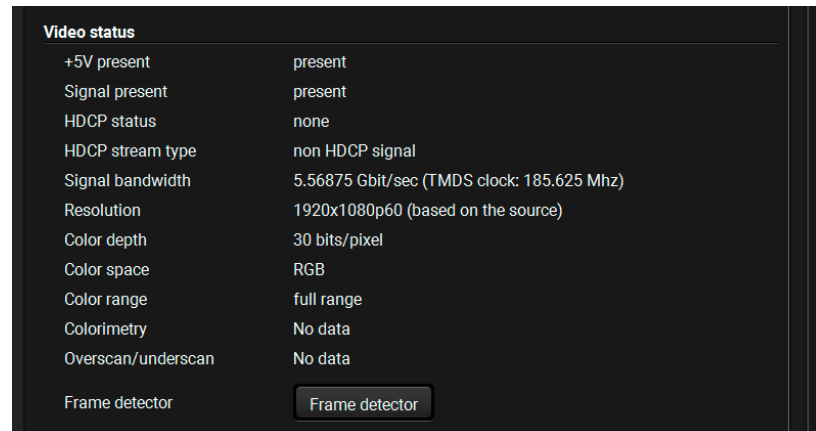

Video status	
+5V present	present
Signal present	present
HDCP status	none
HDCP stream type	non HDCP signal
Signal bandwidth	5.56875 Gbit/sec (TMDS clock: 185.625 Mhz)
Resolution	1920x1080p60 (based on the source)
Color depth	30 bits/pixel
Color space	RGB
Color range	full range
Colorimetry	No data
Overscan/underscan	No data
Frame detector	<input type="button" value="Frame detector"/>

Video status information in the input port properties window

The following signal status information is displayed in this section:

+ 5V present, Signal present, [HDCP status](#), HDCP stream type, Signal bandwidth, Resolution, Color depth, Color space, Color range, Colorimetry, Overscan/underscan, [Frame Detector](#).

HDCP status

The currently applied HDCP encryption level on the input (e.g. HDCP 1.4).

- **non HDCP signal:** the signal is not encrypted.
- **HDCP 1.4 stream:** the signal is encrypted with HDCP v1.4
- **HDCP 2.2 stream (HDCP 1.4 convertible):** the signal is encrypted with HDCP 2.2, but can be converted to be encrypted with HDCP v1.4. See the corresponding section in the [HDCP v2.2](#) section (the first figure).
- **HDCP 2.2 stream (non HDCP 1.4 convertible):** the signal is encrypted with HDCP 2.2, and is not allowed to be converted and encrypted with HDCP v1.4. In this case the signal can be displayed only on a HDCP v2.2-compliant sink device.

General Tab - Embedded audio

Presence of the embedded audio and the sampling frequency are displayed in Embedded audio section.

CEC Tab

The MX2-HDMI20 series is able to send and receive Consumer Electronic Control (CEC) commands. This feature is for remote control of the source or sink device. CEC is a bi-directional communication via HDMI or DP cable, in this case between the source and the input port of the matrix switcher. #cec

ATTENTION! Make sure that the controlled unit is CEC-capable and that this function is enabled.



Layout of CEC panel in Lightware Device Controller

- 1 **Tab selector** Select the **CEC** tab for managing CEC commands.
- 2 **Drop-down command list** This list contains the basic CEC commands, most of them are displayed on the graphical interface, too (on the left side). Click on the **Send** button to execute sending the command.
- 3 **Custom command textbox** The text field is for sending hexadecimal commands to the source. The maximum length of the message could be 30 characters long (15 bytes). Click on the **Send** button to confirm.
- 4 **OSD string textbox** A max. 14 character-long text can be shown on the source device. The send OSD (On-screen display) command textbox is the input field of the string. Alphanumeric characters, glyphs and space are accepted. Click on the **Send** button to execute the command.
- 5 **Received Command box** This window displays all the sent (in red) CEC commands and the received answers (in blue) with a timestamp.
Legend of the received message:
 < [10:33:17] ACK
 Answer for the acknowledged command.
 < [10:35:01] NACK
 Answer for the not acknowledged command.
 < [10:33:17] IN PROGRESS
 The command is in progress at the moment.
 < [10:33:17] FAILED
 Answer for other failure.
 < [10:35:40] feature_abort_<*>
 This is the most common answer from the third-party devices when the command is delivered, but the execution is refused. The cause of the refuse stands after 'feature_abort' expression.
- 6 **Clear button** Click on the **Clear** button to erase the content of the terminal window.
- 7 **CEC command button panel** This panel provides the quick and easy management of CEC commands. The buttons are pre-programmed with basic functions and send commands towards the source. The communication is displayed in the Received Command box. For the list of commands, see the [Sending CEC Commands Towards the Source](#) section. Both the layout and functionality are similar to the design of a remote control.

INFO: The first 2x2 bit are the source and destination address. In this case that is always 04.

INFO: According to the standard, the CEC feature works only at HDMI ports.

Advanced Tab

AVI Infoframe, Audio InfoFrame, Vendor Specific Infoframe

Advanced signal information can be displayed on this tab if the video signal contains them. It could be used for cable diagnostic purpose.

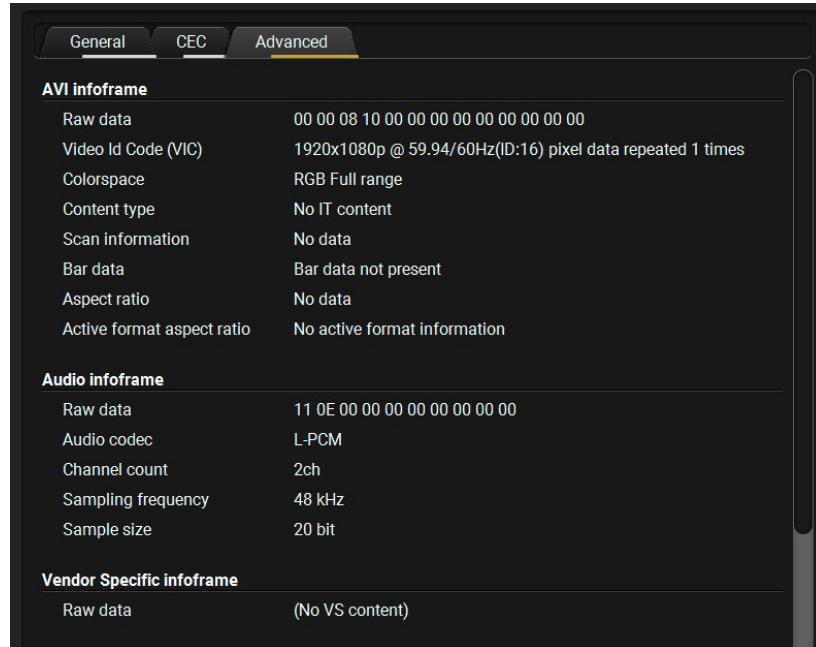

Advanced tab in the input port properties window

High Dynamic Range (HDR) Infoframe

This layout supports the HDR signal analysis by converting the raw infoframe data to a human-readable format. When the video signal is HDR and its infoframe contains metadata, then it will be displayed in this tab. #hdr

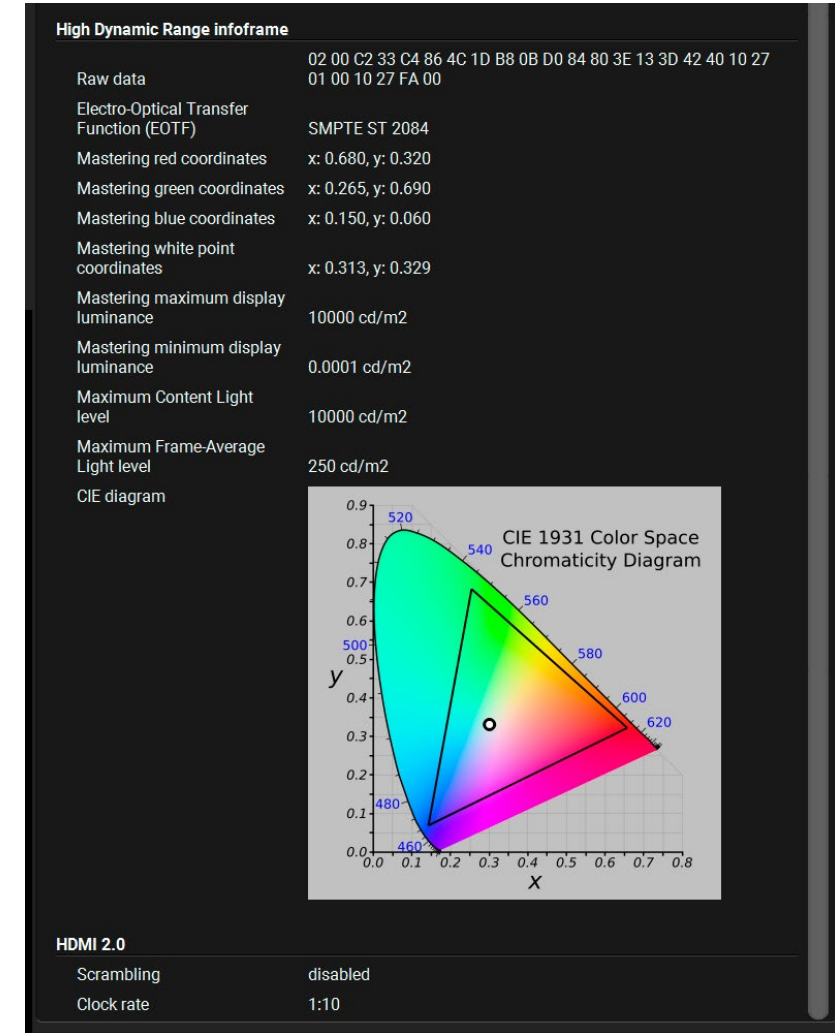

Advanced tab in the input port properties window

HDMI 2.0

- HDMI 2.0 related information: Scrambling / Clock rate

7.5.2. DisplayPort Inputs

INFO: This window appears only when the selected port is DisplayPort. See the [Model Comparison](#) table on which model has DP input.

Click on a port to display its properties; Signal status information and the most important parameters.

General Tab- General

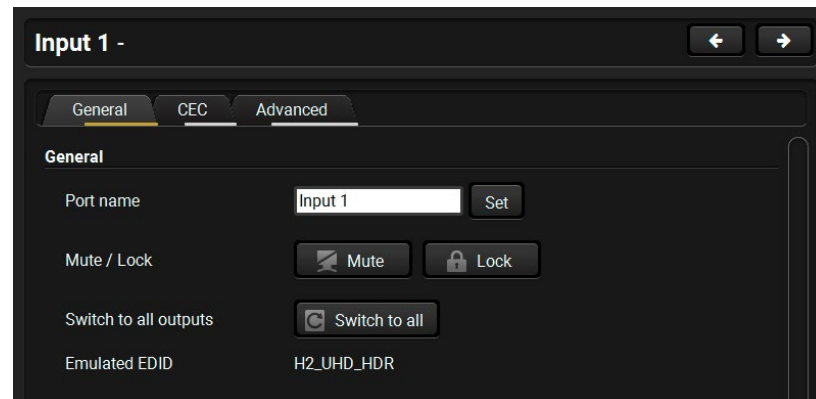

General tab in the input port properties window

Port name

The name of a port can be changed by typing the new name and clicking on the **Set** button. The following characters are allowed when naming: Letters (A-Z) and (a-z), hyphen (-), underscore (_), numbers (0-9), and dot (.). Max length: 63 characters.

Mute *#mute #unmute*

The incoming signal can be muted/unmuted by pressing the button. If the port is muted, button text is **Unmute**. In this case no signal is transmitted from the input port.

Lock *#lock #unlock*

The port can be locked to the currently connected output ports by the button. If the port is locked, button text is **Unlock**. In this case the mute state and the crosspoint state of this port cannot be changed.

Switch to all

The input port will be switched to all output ports.

Emulated EDID

The name of the currently emulated EDID (displays the **Monitor Name** in the EDID menu).

General Tab - Displayport Link

This section has a built-in help in the LDC. Click on the **i** icon to open the related info textbox in a pop-up window.

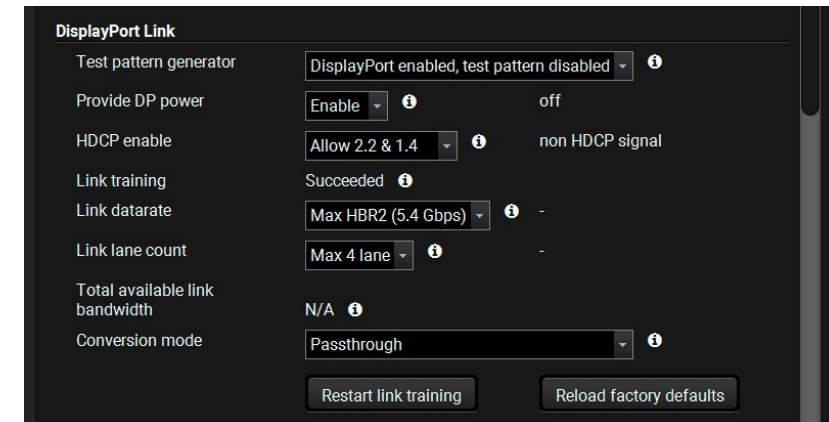

DisplayPort settings in the input port properties window

Test pattern generator * *#testpattern #nosyncscreen*

- **DisplayPort enabled, test pattern disabled:** default value for DP video transmission.
- **DisplayPort disabled, test pattern enabled:** This function makes it possible to route the analog audio towards the output without any video transmission. Enabling testpattern will disable the DisplayPort connector.

* Test pattern generator option appears only in **-A or -Audio** suffixed models, where there is an analog audio port beside the DP port.

Provide DP Power *#testpattern #nosyncscreen*

- **Enable /Disable:** DisplayPort input ports are capable of providing about 1.5 W (500 mA @ 3.3V) power on the DP_PWR pin. As in DisplayPort copper cables this pin is not connected, the setting has no effect when a PC or a media player is attached to the respective port. Typically, this feature can be used for powering DisplayPort dongles, adapters and active optical cables that do not have external power supplies. The matrix is also capable of detecting and displaying short circuit conditions where the current exceeds the 500 mA limit. Adjusting these settings may help restarting or powering down the connected device.

HDCP enable *#hdcpc*

- **Disable HDCP on input:** The connected source will detect that the matrix is not HDCP-compliant and turn off authentication if the content allows it.
- **Allow HDCP 1.4 only*:** The connected source will detect that the matrix is compliant with HDCP 1.4, but not compliant with HDCP 2.2.
- **Allow HDCP 2.2 and HDCP 1.4:** The connected source will detect that the matrix is compliant with HDCP 2.2.
- **High Value mode (limit switching to HDCP 2.2 sinks):** Any version of HDCP is allowed on the input, but the incoming signal is always internally upconverted to HDCP 2.2 content, and thus cannot be switched to HDCP 1.4 sinks.

*The availability of this setting depends on the hardware version of the input board (V1x_) and the port type (HDMI), only in MX2-8x8-HDMI20 model. The hardware version can be found in the [Status Tab](#) in the LDC or in the [System Settings Menu](#), [Device Info](#) submenu in the LCD.

Link training *#linktraining*

This is a status information about the success of the link training. The result of the connection can be succeeded or not ready.

Link training is a process where the source (PC, laptop, media server) and the sink (matrix) agree on a data rate, lane count and electrical parameters. The successful link training is a pre-requisite of the video transmission. If the quality of the DisplayPort cable is insufficient to reliably handle higher data rates, link training will result in a lower data rate where stable connection between the source and the matrix can be maintained.

Clicking on the **Restart Link Training** button starts to build up the connection again between the matrix switcher and the source (it happens automatically when the source is connected). It is equal to unplugging the DP connector and reconnecting it.

Link datarate

The DisplayPort 1.2 standard uses fix data rates on the high-speed lanes. With this setting, it is possible to limit the maximum data rate. Please note that the source can use lower data rate if the quality of the cable is low.

- **Max RBR:** Reduced Bit Rate uses 1.62 Gbps bandwidth per lane
- **Max. HBR:** High Bit Rate (HBR) uses 2.70 Gbps
- **Max. HBR2:** HBR2 is the fastest mode with a data rate of 5.40 Gbps per lane

INFO: RBR and HBR are defined in the DisplayPort 1.0-1.1a standards, while HBR2 was introduced in DisplayPort 1.2.

Link lane count

DisplayPort cables have four high-speed lanes, each of them are capable of transmitting data at a rate of 5.40 Gbps.

The following parameters can be set:

- **Max. 1 lane:** Transmits data at a rate of 5.40 Gbps.
- **Max. 2 lane:** Transmits data at a rate of 10.80 Gbps.
- **Max. 4 lane:** Transmits data at a rate of 21.60 Gbps.

The source and the sink agree on the link lane count during the link training process. Fewer link lanes result in lower power consumption at the transmitter side. With this setting, it is possible to limit the number of link lanes used.

INFO: Please note that the source can still use fewer lanes if there is no need for high data rates.

Total available link bandwidth

Displays the maximum available bandwidth.

The total available link bandwidth is the actual [Link datarate](#) multiplied by the [Link lane count](#). If the bandwidth of the video stream is higher than the total available link bandwidth, then it is not possible to transmit the video stream over the link.

Conversion mode *#colorspace*

The following settings are available:

- **Passthrough:** the video signal is transmitted to the output without any changing.
- **RGB 4:4:4 to YCbCr 4:2:2 12 bit:** the video converter subsamples the 4:4:4 signal to 4:2:2.
- **RGB 4:4:4 to YCbCr 4:2:0 8 bit:** the video converter subsamples the 4:4:4 signal to 4:2:0.

INFO: When the DisplayPort source sends RGB 4:4:4 10-bit HDR signal, then it will be converted to 8-bit HDMI signal, **if the AV signal exceeds the bandwidth limitation of the HDMI 2.0 standard**, else the original content is transmitted. Enabling YCbCr 4:2:2 conversion will save bandwidth by chroma subsampling and preserve the color depth.

Below the Displayport Link section, the summary of the DP-related settings and status information of the selected port can be seen.



Status information of the active signal

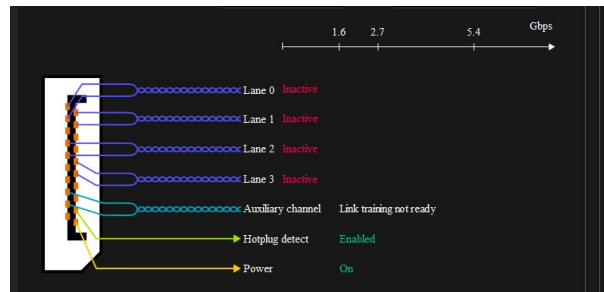

Status information of the disconnected port

The audio setting possibilities are the same with the HDMI port's. For more details see the [General Tab - Audio Settings](#) section.

#status

Video status

The signal format and the detected parameters are described in these sections.

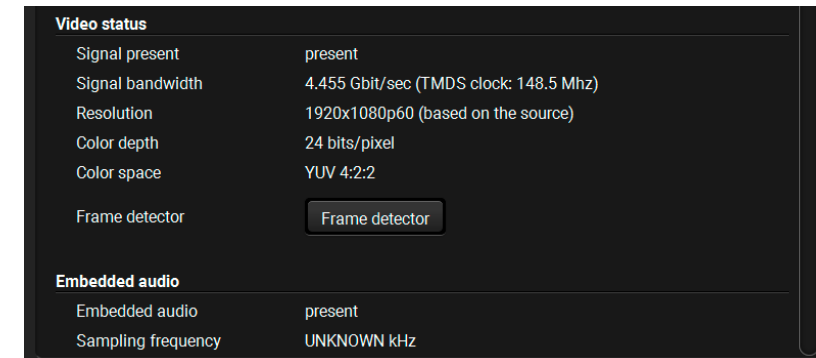

Video status information in the input port properties window

The following signal status information is displayed in this section:

- **Signal present**
- **Signal bandwidth**
- **Resolution**
- **Color depth**

INFO: Make sure the emulated EDID supports deep color in case of 10-bit or 12-bit color depth video signal. For more information about it, see [DisplayPort Video Options](#).

- **Color space**
- **Frame Detector**

Embedded audio

The embedded audio's presence and the sampling frequency are displayed in the Embedded audio section.

CEC Tab *#cec*

The DisplayPort CEC-capability is similar to the HDMI, for more details about the CEC command sending, see the [CEC Tab](#) section.

Advanced Tab

See more details about the advanced signal information in the [Advanced Tab](#) section.

7.6. Output Port Properties

7.6.1. HDMI Outputs

Click on a port to display its properties.

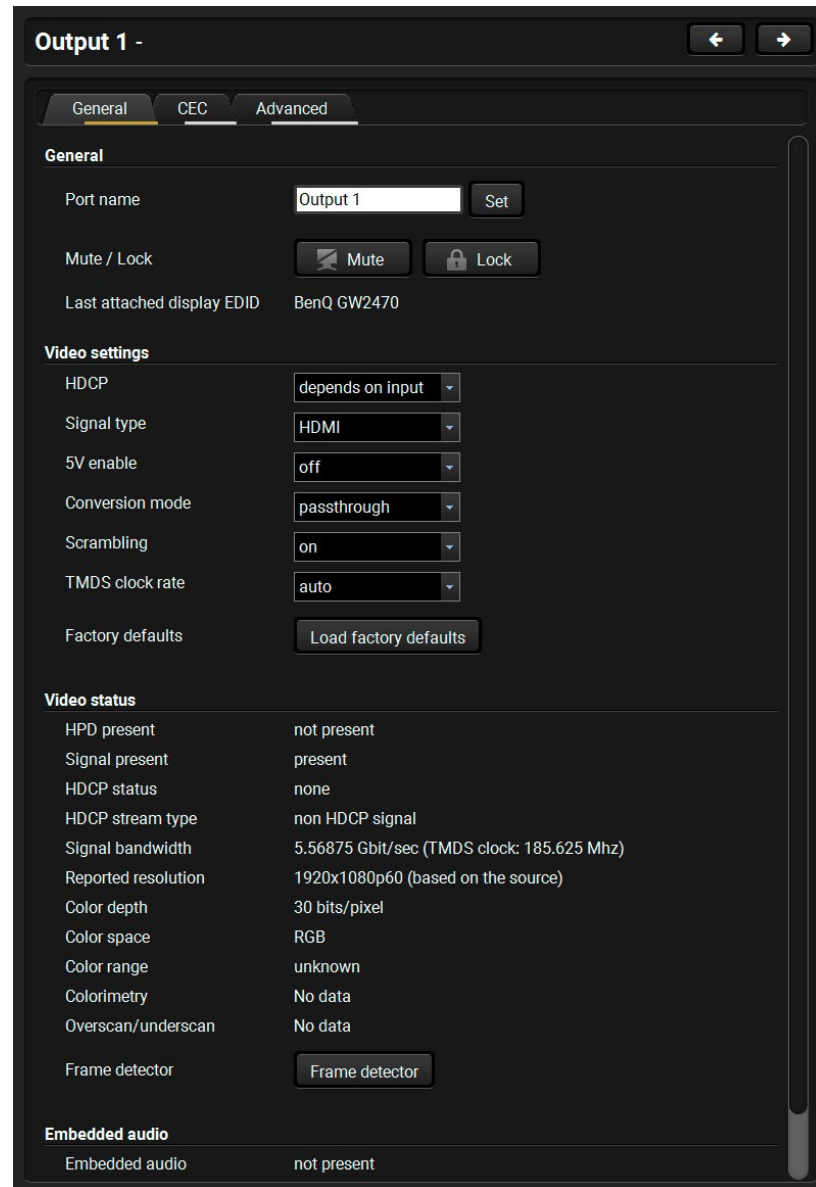

Output port properties window

General Tab - General

Port name

The name of a port can be changed by typing the new name and clicking on the **Set** button. The following characters are allowed when naming: Letters (A-Z) and (a-z), hyphen (-), underscore (_), numbers (0-9), and dot (.). Max length: 63 characters.

Mute #mute #unmute

The incoming signal can be muted/unmuted by pressing the button. If the port is muted, button text is **Unmute**. In this case, no signal is transmitted to the output port.

Lock #lock #unlock

The output port can be locked to the currently connected input port via the button. If the port is locked, button text is **Unlock**. In this case the mute state and the crosspoint state of the port cannot be changed.

Last attached display EDID

The name of the last attached monitor's EDID is displayed (shown as **Monitor Name** in the EDID menu).

General Tab - Video settings

HDCP #hdcp

- **Depends on input:** the encryption level depends on the settings of the input port and the source content/device. If the incoming signal is not encrypted, then the outgoing signal will not be encrypted either.
- **Maximum possible:** the highest supported level of encryption (between the matrix and the sink) is applied (up to HDCP v2.2).

Signal type

The outgoing signal format can be selected from a drop-down list:
Auto, HDMI, DVI.

5V enable #power5v

- **On:** +5V power is always sent, thus the sink and the port are always connected.
- **Off:** +5V power is not sent towards the sink, thus the sink does not sense the connection.

Conversion mode *#colorspace*

DIFFERENCE: Only the MX2-8X8-HDMI20-AUDIO-L model is capable of 4:4:4 to 4:2:0 conversion and the split function. The availability of this setting depends on the hardware version of the output board (V1x_), only in MX2-8x8-HDMI20 model. The hardware version can be found in the [Status Tab](#) in the LDC or in the [System Settings Menu, Device Info](#) submenu in the LCD.

- **Passthrough:** no signal conversion.
- **4:4:4 to 4:2:0 :** the signal is converted to the indicated color depth.
- **4:4:4 to 4:2:2:** the signal is converted to the indicated color depth.

ATTENTION! 10 bit 4:4:4- video signal is converted to 12 bit 4:2:2.

- **LEFT part/RIGHT part :** The device supports vertical splitting of an HDMI 2.0 4k@60Hz 4:4:4 input signal to left and right halves, allowing the transmission of an 18Gbps HDMI2.0 signal over two HDMI1.4 compliant links. The two halves can then be recombined at the signal destination. To apply the feature, route the same input signal to 2 output ports. Set the conversion to **Left** on one output port and **Right** on the other output port. See the application diagram in the [Typical Application](#) chapter.

Scrambling *#scrambling*

HDMI 2.0 standard introduced scrambling to the TMDS encoding, which helps to decrease the energy peaks, and hence the Electro Magnetic Interference (EMI). To maintain backwards compatibility, HDMI 2.0 only requires the use of scrambling with data rates of above 3.4 Gbps per lane. The feature can be set on the output ports to **On / Off** or **Auto** (recommended).

TMDS clock rate

Setting the value to **1:10**, **1:40** or **Auto** (recommended).

Factory defaults

Resetting the default values:

- **HDCP** = depends on input; **Signal type** = auto; **Conversion mode** = passthrough; **Scrambling** = auto; **TMDS clock rate** = auto.

General Tab - Audio settings *#audio #analogaudio #mute #unmute*

INFO: Analog audio properties appear only in **-A** or **-Audio** suffixed models, where there is an analog audio port beside the HDMI port.

Mute analog output

The analog audio output signal can be muted by this option.

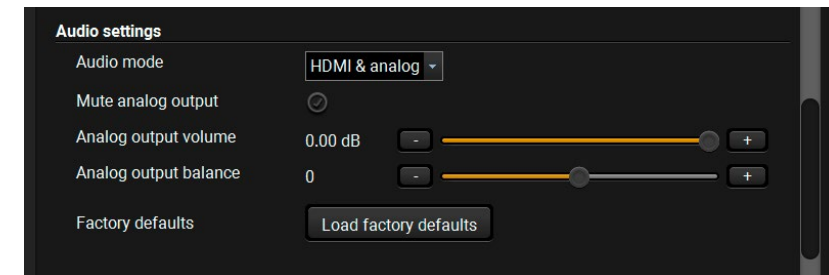

Analog audio settings in the output port properties window

Analog output volume

Setting the value between -95.62 dB and 0 dB.

Analog output balance

Setting the value between -100 and +100 (0 = center).

Factory defaults

Resetting the default values:

- **Analog output** = unmuted,
- **Analog output volume** = 0,
- **Analog output balance** = 0 (center).

General Tab - Video status

The signal format and the detected parameters are described in these sections.

Video status	
HPD present	not present
Signal present	present
HDCP status	none
HDCP stream type	non HDCP signal
Signal bandwidth	5.56875 Gbit/sec (TMDS clock: 185.625 Mhz)
Reported resolution	1920x1080p60 (based on the source)
Color depth	30 bits/pixel
Color space	RGB
Color range	unknown
Colorimetry	No data
Overscan/underscan	No data
Frame detector	<input type="button" value="Frame detector"/>

Video status information in the output port properties window

The following signal status information is displayed in this section:

HPD present, Signal present, [HDCP status](#), [HDCP stream type](#), Signal bandwidth, Reported resolution, Color depth, Color space, Color range, Colorimetry, Overscan/underscan, [Frame Detector](#).

HDCP status *#hdcp*

The currently applied HDCP encryption level (e.g. HDCP 1.4)

HDCP stream type

- **non HDCP signal:** the signal is not encrypted.
- **HDCP 1.4 stream:** the signal is encrypted with HDCP v1.4
- **HDCP 2.2 stream (HDCP 1.4 convertible):** the signal is encrypted with HDCP 2.2, but can be converted to be encrypted with HDCP v1.4. See the corresponding section in [HDCP v2.2](#) (the first figure).
- **HDCP 2.2 stream (non HDCP 1.4 convertible):** the signal is encrypted with HDCP 2.2 and is not allowed to be converted and encrypted with HDCP v1.4. In this case the signal can be displayed only on a HDCP v2.2 compliant sink device.

Advanced tab

General		CEC		Advanced		
Signal quality						
Signal error rate	TMDS Data 0	0	TMDS Data 1	0	TMDS Data 2	0
<p>These counters show the number of received TMDS error codes per second. The measurement requires an HDMI 2.0 compliant receiver and the exact results may depend on the implementation of the used receiver.</p>						
AVI infoframe						
Raw data	10 A8 00 10 00 00 00 00 00 00 00 00					
Video Id Code (VIC)	1920x1080p @ 59.94/60Hz(ID:16) pixel data repeated 1 times					
Colorspace	invalid (may be RGB)					
Content type	No IT content					
Scan information	No data					
Bar data	Bar data not present					
Aspect ratio	16:9					
Active format aspect ratio	Same as picture					
Audio infoframe						
Raw data	-					
Audio codec	-					
Channel count	-					
Sampling frequency	-					
Sample size	-					

Advanced tab in the output port properties window

Signal quality

Signal information is available on this tab, which can be used for cable diagnostic purpose. The following information is displayed:

- Signal error rate: number of the faulty characters per second
- INFO: If the signal error rate is zero, it refers to the perfect data transmission. However, some sources send character errors consciously during their regular operation.
- BCH ECC errors: Bose–Chaudhuri–Hocquenghem Error Correction Codes errors mean the error rate of the data packages.

See more details about the advanced signal information in [section](#).

7.6.2. Frame Detector

The ports can show detailed information about the signal like full size and active video resolution. This feature is a good troubleshooter if compatibility problems occur during system installation. To access this function, open the port properties window and click on the **Frame detector** button. #framedetector

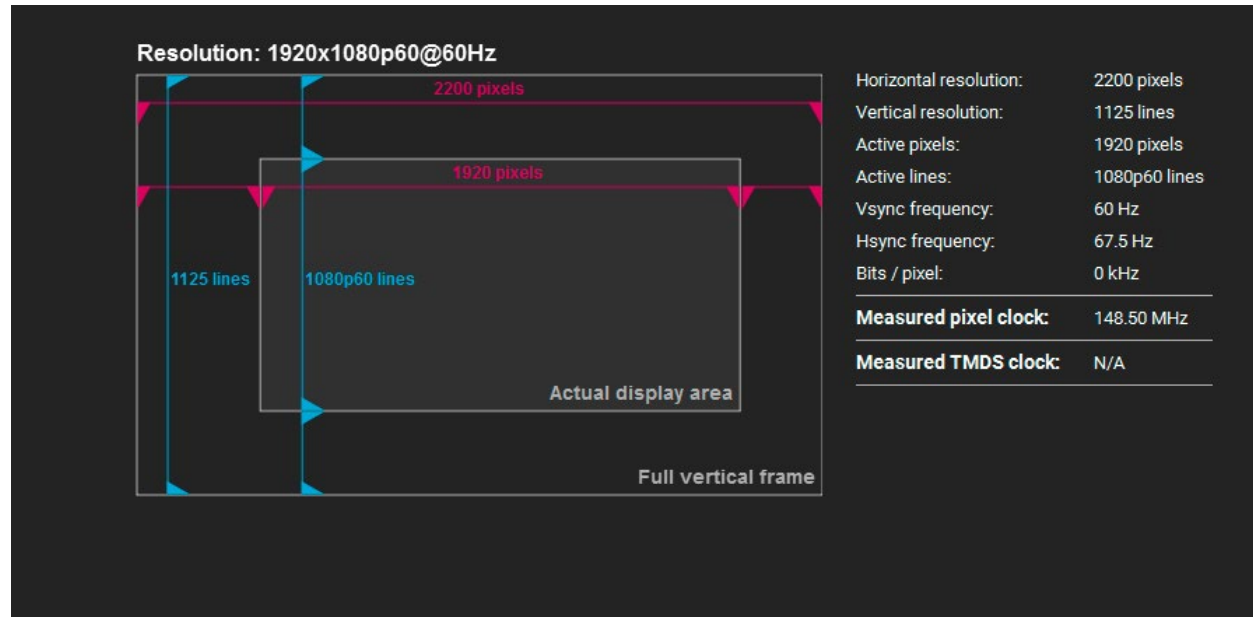

Frame Detector Window

Lightware's Frame Detector function works like a signal analyzer and makes it possible to determine the exact video format that is present on the port, thus helps to identify many problems. E.g. actual timing parameters may differ from the expected, and this may cause some displays to drop the picture.

Frame Detector measures detailed timings on the video signals just like a built-in oscilloscope, but it is much more easy to use. Actual display area shows the active video size (light grey). Dark grey area of the full frame is the blanking interval, which can contain the info frames and embedded audio data for HDMI signals. Shown values are measured directly on the signal and not retrieved only from the HDMI info frames.

7.6.3. DisplayPort Outputs

Click on a port to display its properties.

Output 7 -

General

Port name: Output 7 [Set]

Mute / Lock: [Mute] [Lock]

Last attached display EDID: S277HK

DisplayPort Link

Provide DP power: [Enable] on

Hotplug: present

HDCP: [Auto] none

Link training: [Automatic] successful

Link data rate: [HBR2 (5.4 Gbps)] HBR2 (5.4 Gbps)

Link lane count: [4 lanes] 4 lanes

Swing / pre-emphasis: [400 mV / 0 dB] 800 mV / 0 dB

Clock recovery: Lane 0: [On] Lane 1: [On] Lane 2: [On] Lane 3: [On]

Symbol lock: Lane 0: [On] Lane 1: [On] Lane 2: [On] Lane 3: [On]

[Restart link training] [Reload factory defaults]

Speed: 5.4 Gbps, 2.7 Gbps, 1.6 Gbps

Link training succeeded: [On]

Auxiliary channel: [On]

Hotplug detect: [On]

Power: [On]

The window also features a diagram of the DisplayPort connector with four lanes (Lane 0-3) and an auxiliary channel, each showing a signal strength of 5.4 Gbps.

Output port properties window

General Tab - General

Port name

The name of a port can be changed by typing the new name and clicking on the **Set** button. The following characters are allowed when naming: Letters (A-Z) and (a-z), hyphen (-), underscore (_), numbers (0-9), and dot (.). Max length: 63 characters.

Mute *#mute #unmute*

The incoming signal can be muted/unmuted by pressing the button. If the port is muted, button text is **Unmute**. In this case, no signal is transmitted to the output port.

Lock *#lock #unlock*

The output port can be locked to the currently connected input port by the button. If the port is locked, button text is **Unlock**. In this case the mute state and the crosspoint state of the port cannot be changed.

Last attached display EDID

The name of the last attached monitor's EDID is displayed (shown as **Monitor Name** in the EDID menu).

General Tab - Displayport Link

This section has a built-in help in the LDC. Click on the **i** icon to open the related info textbox in a pop-up window.

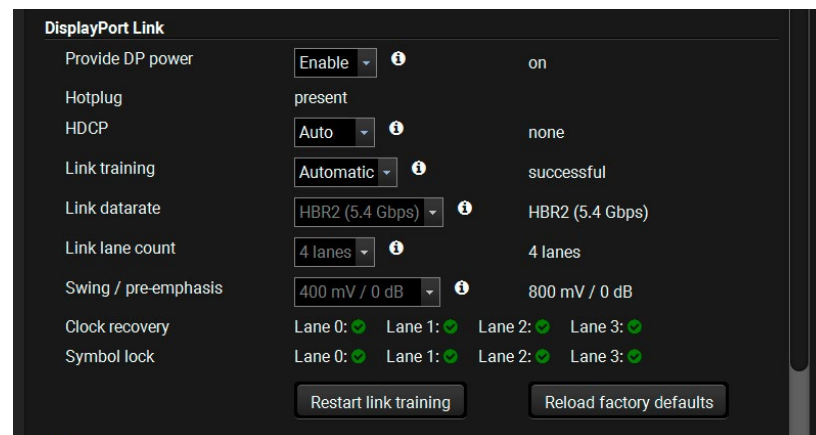

DisplayPort settings in the input port properties window

Provide DP Power *#dppower*

- **Enable /Disable:** DisplayPort output ports are capable of providing about 1.5 W (500 mA @ 3.3V) power on the DP_PWR pin. As in DisplayPort copper cables this pin is not connected, the setting has no effect when a PC or a media player is attached to the respective port. Typically, this feature can be used for powering DisplayPort dongles, adapters and active optical cables that do not have external power supplies. The matrix is also capable of detecting and displaying short circuit conditions where the current exceeds the 500 mA limit. Adjusting these settings may help restarting or powering down the connected device.

HDCP enable *#hdcp*

- **Auto:** The matrix forces the source to send the signal without encryption if the content allows.
- **Always:** The matrix forces the source to send the signal with encryption.

Link training *#linktraining*

- **Automatic:** The link training process starts without any user interruption, parameters are set automatically. Using this setting is highly recommended!
- **Forced:** This mode means that the link training process is skipped, the signal sending is based on the configured values of [Link datarate](#), [Link lane count](#), . Only for advanced users for special troubleshooting cases!

INFO: Certain displays require the standard link training process and will not display the video without it.

Link datarate

INFO: This drop-down menu becomes active when the **Link training** is set to **Forced**.

The DisplayPort 1.2 standard uses fix data rates on the high-speed lanes. This setting defines the fix datarate. If the quality of the cable is low, lower data rate setting is recommended.

- **RBR:** Reduced Bit Rate uses 1.62 Gbps bandwidth per lane.
- **HBR:** High Bit Rate (HBR) uses 2.70 Gbps.
- **HBR2:** HBR2 is the fastest mode with a data rate of 5.40 Gbps per lane.

INFO: RBR and HBR are defined in the DisplayPort 1.0-1.1a standards, while HBR2 was introduced in DisplayPort 1.2.

Link lane count

INFO: This drop-down menu becomes active when the **Link training** is set to **Forced**.

DisplayPort cables have four high-speed lanes, each of them are capable of transmitting data at a rate of 5.40 Gbps.

The following parameters can be set:

- **1 lane:** Transmits data at a rate of 5.40 Gbps.
- **2 lane:** Transmits data at a rate of 10.80 Gbps.
- **4 lane:** Transmits data at a rate of 21.60 Gbps.

Fewer link lanes result in lower power consumption at the transmitter side. With this setting, it is possible to declare the used number of link lanes.

Swing / pre-emphasis

INFO: The drop-down menu becomes active when the **Link training** is set to **Forced**.

In case of low cable quality or unstable signal transmission, the forced voltage level and pre-emphasis level can be changed on main link lanes. This setting is valid for all lanes.

The following values can be chosen from the drop-down menu:

- 400mV / 0 dB
- 400mV / 3.5 dB
- 400mV / 6 dB
- 600mV / 0 dB
- 600mV / 3.5 dB
- 600mV / 6 dB
- 600mV / 9.5 dB
- 800mV / 0 dB
- 800mV / 3.5 dB

Clock recovery and symbol lock

The clock recovery and symbol lock status information appear on each lines. It gives a feedback about the successful link training.

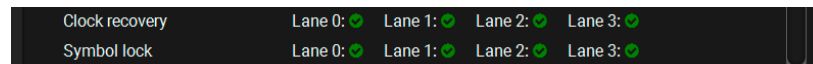

Successful clock recovery and symbol lock on every lane

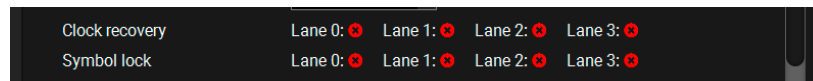

The clock recovery and symbol lock were not successful

INFO: This status information comes from self-test of the link training process. When the link training is set to forced, the matrix does not perform the link training, so the clock recovery and symbol lock is always unsuccessful.

Restart link training

Clicking on the **Restart Link Training** button starts to build up the connection again between the matrix switcher and the sink (it happens automatically when the sink is connected). It is equal to unplugging the DP connector and reconnecting it.

Reload factory defaults

Resetting the default values for Displayport Link section.

General tab- Audio settings

ATTENTION! The DisplayPort output ports cannot transmit embedded audio stream with more than 2 channels due to a bandwidth limitation. Accepted audio signals are 2-channel PCM between 48 and 192 kHz.

See more details about this tab in the [General Tab - Audio Settings](#) section.

General tab - Video status

See more details about this tab in the [Video status](#) section.

General tab - Embedded audio

The embedded audio's presence and the sampling frequency are displayed in the [General Tab - Embedded audio](#) section.

Advanced Tab

See more details about the advanced signal information in the [Advanced Tab](#) section.

7.7. Presets

The router can store presets and the following are stored in each slot: input/output crosspoint state, muted/unmuted states. Preset loading has an effect on all ports, except the locked ones. #preset

ATTENTION! When factory default settings are restored, presets are deleted.

ATTENTION! The Preset loading has an effect on all ports, except the locked ones.

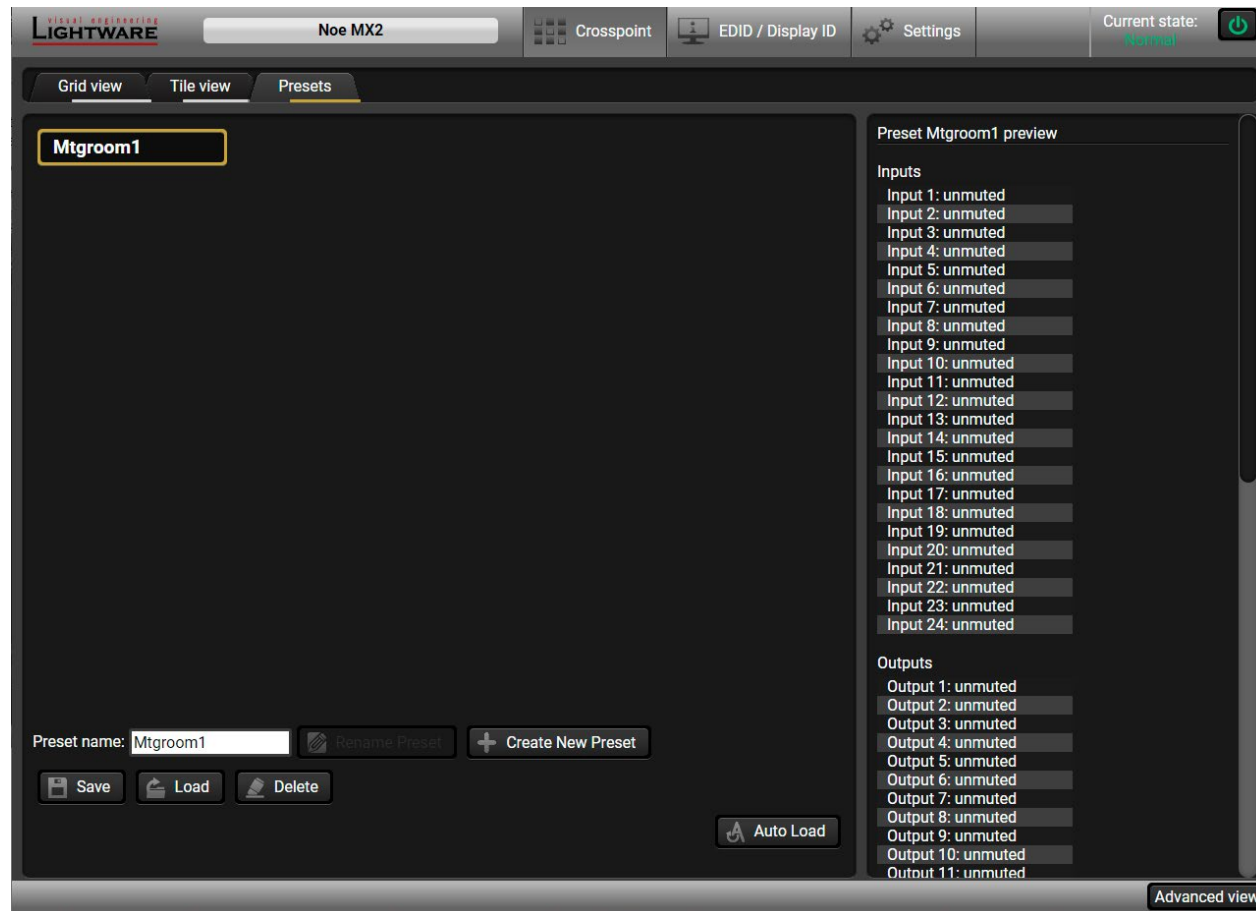

Presets Tab

Loading a Preset

Step 1. Select the **Presets** tab from the **Crosspoint** menu.

Step 2. Select the desired preset; check the **Preview** panel and press the **Load** button. Press **Yes** in the confirmation window.

INFO: Presets that were saved by the front panel buttons previously are listed with names Button1.. Button8 as default. See the corresponding [Save or Load a Preset](#) section.

Auto load mode

When the **Auto load** button is highlighted with green, the mode is active. In this case, confirmation is **not** required: the selected preset is loaded immediately when the button is pressed.



Saving a Preset to an Empty Slot

Step 1. Arrange the desired crosspoint connections in **Tile view** or **Grid view**.

Step 2. Select the **Presets** tab from the **Crosspoint** menu and type the desired **Preset name** in the indicated text field, its length can up to 16 characters. The following are allowed when naming: letters (A-Z and a-z), hyphen (-), underscore (_), and numbers (0-9).

Step 3. Press the **Create New Preset** button to store the configuration.

Overwriting an Existing Preset

Step 1. Arrange the desired crosspoint connections in **Tile view** or **Grid view**.

Step 2. Select an existing preset, press the **Save** button and **Yes** to confirm.

Renaming a Preset

Step 1. Select the desired preset you want to rename.

Step 2. Type the desired name and press the **Rename Preset** button.

Deleting a Preset

Step 1. Select the desired preset you want to delete.

Step 2. Press the **Delete** button and **Yes** to confirm.

7.8. EDID Menu









Advanced EDID Management can be accessed by selecting the EDID menu. There are two panels: left one contains **Source EDIDs**, right one contains **Destination** slots where the EDIDs can be emulated or copied.

Me...	Manufa...	Resolution	Audio	Monitor Name
F131	LWR	4096x2160p25.00...	2chLPCM	H4096x2160p25
F132	LWR	4096x2160p30.00...	2chLPCM	H4096x2160p30
F133	LWR	4096x2160p60.00...	2chLPCM	4Kp60_420
F134	LWR	3440x1440p23.99...	2chLPCM	H3440x1440p24
F135	LWR	4096x2160p24.00...	2chLPCM	H4096x2160p24
F136	LWR	3840x2400p29.99...	2chLPCM	H3840x2400p30
F137	LWR	3840x2160p60.00...	2chLPCM	HUHDp60_444
F138	LWR	3840x2160p50.00...	2chLPCM	HUHDp50_444
F139	LWR	3840x2160p60.00...	2chLPCM	H2_UHD_PCM
F140	LWR	3840x2160p60.00...	2chLPCM,8ch...	H2_UHD_ALL
F141	LWR	4096x2160p60.00...	2chLPCM	H4Kp60_444
F142	LWR	4096x2160p50.00...	2chLPCM	H4Kp50_444
F143	LWR	4096x2160p60.00...	2chLPCM	H2_4K_PCM
F144	LWR	4096x2160p60.00...	2chLPCM,8ch...	H2_4K_ALL
F146	LWR	3840x2160p60.00...	2chLPCM	H2_UHD_HDR
F147	LWR	3840x2160p60.00...	2chLPCM	H2_UHD_RB_PCM
F148	LWR	3840x2160p60.00...	2chLPCM,8ch...	H2_UHD_RB_ALL
F150	LWR	5120x1440p29.97...	2chLPCM,8ch...	H5120x1440p30
F151	LWR	5120x2160p29.97...	2chLPCM,8ch...	H5120x2160p30
F152	LWR	5120x2880p29.97...	2chLPCM,8ch...	H5120x2880p30
F153	LWR	7680x1080p59.94...	2chLPCM,8ch...	H7680x1080p60

Memory	M...	Resolution	Audio	Monitor Name	So...
E4	LWR	1920x1080p60.00...	2chLPCM...	Univ_HDMI_DC	F49
E5	LWR	1920x1080p60.00...	2chLPCM...	Univ_HDMI_DC	F49
E6	LWR	1920x1080p60.00...	2chLPCM...	Univ_HDMI_DC	F49
E7	LWR	1920x1080p60.00...	2chLPCM...	Univ_HDMI_DC	F49
E8	LWR	1920x1080p60.00...	2chLPCM...	Univ_HDMI_DC	F49
E9	LWR	1920x1080p60.00...	2chLPCM...	Univ_HDMI_DC	F49
E10	LWR	1920x1080p60.00...	2chLPCM...	Univ_HDMI_DC	F49
E11	LWR	1920x1080p60.00...	2chLPCM...	Univ_HDMI_DC	F49
E12	LWR	1920x1080p60.00...	2chLPCM...	Univ_HDMI_DC	F49
E13	LWR	1920x1080p60.00...	2chLPCM...	Univ_HDMI_DC	F49
E14	LWR	1920x1080p60.00...	2chLPCM...	Univ_HDMI_DC	F49
E15	LWR	1920x1080p60.00...	2chLPCM...	Univ_HDMI_DC	F49
E16	LWR	1920x1080p60.00...	2chLPCM...	Univ_HDMI_DC	F49
E17	LWR	1920x1080p60.00...	2chLPCM...	Univ_HDMI_DC	F49
E18	LWR	1920x1080p60.00...	2chLPCM...	Univ_HDMI_DC	F49
E19	LWR	1920x1080p60.00...	2chLPCM...	Univ_HDMI_DC	F49
E20	LWR	1920x1080p60.00...	2chLPCM...	Univ_HDMI_DC	F49
E21	LWR	1920x1080p60.00...	2chLPCM...	Univ_HDMI_DC	F49
E22	LWR	1920x1080p60.00...	2chLPCM...	Univ_HDMI_DC	F49
E23	LWR	1920x1080p60.00...	2chLPCM...	Univ_HDMI_DC	F49
E24	LWR	1920x1080p60.00...	2chLPCM...	Univ_HDMI_DC	F49

#edid

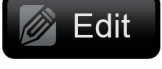
Control buttons

	Export Exporting an EDID (save to a file)		Executing EDID emulation or copying (Transfer button)
	Import Importing an EDID (load from a file)		Deleting EDID (from User memory)
	Info Display EDID Summary window		Selecting all memory places in the right panel
	Edit Opening Advanced EDID Editor with the selected EDID		Selecting none of the memory places in the right panel
	Create Opening Easy EDID Creator		

7.8.1. Sources and Destinations

The EDID memory consists of four parts:

- **Factory EDID list (F1-F148)** the pre-programmed EDIDs, see the [Factory EDID List](#) in the Appendix section.
- **Dynamic EDID list (D1-D8)**: the EDID of the last attached display device. The matrix stores the last EDID from the previously connected sink on each output port. Thus, an EDID can be shown even if there is no device is connected to the output port at that moment.
- **User memory locations (U1 – U100)**: they can be used to save custom EDIDs. Any EDID from the User/Factory/Dynamic EDID lists can be copied to the user memory.
- **Emulated EDID list (E1-E8)**: the currently emulated EDID for the input. The source column displays the memory location that the current EDID was routed from. The source reads the EDID from the Emulated EDID memory on the input port.

There are two types of emulation: **static** and **dynamic**.

- **Static EDID emulation**: an EDID from the Factory or User EDID list is selected. Thus, the Emulated EDID remains the same until the user emulates another EDID.
- **Dynamic EDID emulation**: it can be enabled by selecting D1-D8 EDID memory. The attached monitor's EDID is copied to the input; if a new monitor is attached to the output, the emulated EDID is changed automatically.

7.8.2. EDID Operations

Changing the Emulated EDID

- Step 1.** Choose the desired tab (**Factory**, **Dynamic**, or **User** EDID list) on the left panel and select an **EDID**.
- Step 2.** Select the **Emulated** tab on the right panel.
- Step 3.** Select the **target port** on the right panel (one or more ports can be selected); the EDID(s) will be highlighted with a yellow cursor.
- Step 4.** Press the **Transfer** button to change the emulated EDID.

Learning an EDID

The process is the same as changing the emulated EDID; the only difference is the **Destination** panel: press the **User** button. Thus, one or more EDIDs can be copied into the user memory either from the factory memory or from a connected sink (Dynamic).

Exporting an EDID

Source EDID can be downloaded as a file (*.bin, *.dat or *.edid) to the computer.

- Step 1.** Select the desired **EDID** from the **left panel** (the line will be highlighted with yellow).
- Step 2.** Press the **Export** button to open the dialog box and **save** the file to the computer.

Importing an EDID

Previously saved EDID (*.bin, *.dat or *.edid file) can be uploaded to the **user memory**:

- Step 1.** Select the **User** tab in the left panel and select a memory slot.
- Step 2.** Press the **Import** button below the Source panel.
- Step 3.** Browse the file in the opening window, then press the **Open** button. Browsed EDID is imported into the selected User memory.

ATTENTION! The imported EDID overwrites the selected memory place even if it is not empty.

Deleting EDID(s)

The EDID(s) from User memory can be deleted as follows:

- Step 1.** Select the **User** tab in the left panel.
- Step 2.** Select the desired memory slot(s); one or more can be selected (**Select all** and **Select None** buttons can be used). The EDID(s) will be highlighted with yellow.
- Step 3.** Press the **Clear selected** button to delete the EDID(s).

7.8.3. EDID Summary Window

Select an EDID from Source panel and press the **Info** button to display EDID summary.

The screenshot shows the EDID Summary Window interface. On the left, there is a vertical list of tabs: General, Power Management, Gamma / Colors, Established Timings, Standard Timings, Preferred Timing Mode, 2nd Descriptor Field, 3rd Descriptor Field, 4th Descriptor Field, CEA General, CEA Video, CEA Audio, CEA Speaker Allocation, CEA HDMI VSDB, CEA HDMI Forum VSDB, CEA YCbCr 4:2:0 VDB, CEA YCbCr 4:2:0 Capability Map, CEA Colorimetry, CEA High Dynamic Range, CEA Detailed Timing Descriptors, DisplayID General, DisplayID Product ID, DisplayID Type I Timing #1, DisplayID Type I Timing #2, DisplayID Type I Timing #3, DisplayID Tiled Display Topology, and DisplayID Unknown Blocks. The 'General' tab is selected and highlighted. On the right, the 'General' tab content is displayed, showing the following EDID details:

General	
EDID version:	1
EDID revision:	4
Manufacturer ID:	LWR (Lightware Visual Engineering)
Product ID:	0000
Monitor serial number:	Not present
Year of manufacture:	2010
Week of manufacture:	Not Used
Signal interface:	Digital
Separate Sync H&V:	-
Composite sync on H:	-
Sync on green:	-
Serration on VS:	-
Color depth:	Undefined
Interface standard:	HDMI-a is supported
Color spaces:	RGB 4:4:4 & YCrCb 4:4:4
Aspect ratio:	0
Display size:	0 cm X 0 cm

INFO: Make sure the emulated EDID supports deep color in case of 10-bit or 12-bit color depth video signal. For more information about it, see more information in the [DisplayPort Video Options](#) section. The compatible color depths can be checked in CEA HDMI VSDB tab.

7.8.4. Editing an EDID

Select an EDID from the left panel and press the **Edit** button to display Advanced EDID Editor window. The editor can read and write all descriptors that are defined in the standards, including the additional CEA extension. Any EDID from the device's memory or a saved EDID file can be loaded into the editor. The software resolves the raw EDID and displays it as readable information to the user. All descriptors can be edited, and saved in an EDID file, or uploaded to the User memory. For more details about EDID Editor, please visit our website (https://lightware.com/pub/media/lightware/filedownloader/file/Application-Note/EDID_Editor_Application_Notes.pdf) and download the EDID Editor user's manual.

Basic EDID

- Vendor / Product Information
- Display Parameters
- Power Management and Features
- Gamma / Color and Established Timings
- Standard Timings
- Preferred Timing Mode
- 2nd Descriptor Field
- 3rd Descriptor Field
- 4th Descriptor Field
- CEA Extension
 - General
 - Video Data
 - Audio Data
 - Speaker Allocation Data
 - HDMI VSDB
 - HDMI Forum VSDB
 - YCbCr 4:2:0 VDB
 - YCbCr 4:2:0 Capability Map
 - Colorimetry
 - High Dynamic Range
 - Detailed Timing Descriptor #1
 - Detailed Timing Descriptor #2
 - Detailed Timing Descriptor #3
 - Detailed Timing Descriptor #4
 - Detailed Timing Descriptor #5
 - Detailed Timing Descriptor #6
- Display ID Extension
- Product ID
- Type I Timing Descriptor #1
- Type I Timing Descriptor #2
- Type I Timing Descriptor #3
- Tiled Display Topology
- Unknown DisplayID Data

EDID Byte Editor

	0	1	2	3	4	5	6	7	8	9
0	00	FF	FF	FF	FF	FF	FF	00	32	F2
10	00	00	00	00	00	00	00	14	01	04
20	82	00	00	78	0F	EE	91	A3	54	4C
30	99	26	0F	50	54	FF	FF	80	61	40
40	81	C0	81	00	81	80	81	8F	A9	40
50	D1	C0	D1	00	D8	09	80	A0	20	E0
60	2D	10	08	60	22	01	80	E0	21	00
70	00	18	00	00	00	10	00	00	00	00
80	00	00	00	00	00	00	00	00	00	00
90	00	00	00	FD	00	0F	78	0F	FF	3C
100	04	11	60	00	F8	38	F0	3C	00	00
110	00	FC	00	48	32	5F	34	4B	5F	50
120	43	4D	0A	20	20	20	02	3F		

EDID Editor Window

7.8.5. Creating an EDID

Since the Advanced EDID Editor mentioned above needs more complex knowledge about EDID, Lightware introduced a wizard-like interface for fast and easy EDID creation. With Easy EDID Creator, it is possible to create custom EDIDs in four simple steps. By clicking on the **Create** button below the left panel, Easy EDID Creator is opened in a new window.

Select Resolution & Interface

Welcome to the Easy EDID Creator!

With this software you are able to create a unique EDID according to your demands. Details can be added or changed in the Advanced EDID Editor later if needed.

Please select the format type and the preferred resolution. If you don't find the proper mode in the list, use the Custom format type setting, enter the resolution and the program will estimate the best blanking times.

Important notes:

- If you want to send audio then you must select HDMI or DisplayPort. DVI and VGA do not support audio transmission.
- Most DVI displays are not able to process HDMI signals. If you have a DVI display, please check its specifications.
- The supported color depth will be 24bits/pixel by default.

Format type:

Resolution:

Interface type: VGA DVI HDMI DisplayPort

Easy EDID Creator Wizard

7.8.6. Display ID Extension

The Display ID is defined by a VESA standard as part of the EDID structure. The Advanced EDID editor gets a Display ID section where additional metadata is stored for the video sources about the display capabilities.

INFO: EDID has only 11 bit for active resolution dimensions, it means that the maximum pixel number is 4095.

DisplayID extension supports high resolution displays and tile mode. This interface provides easy and user-friendly input of the Display ID information. `#displayid`

The screenshot shows the EDID Editor Window with a sidebar on the left containing a list of descriptor fields. The 'Tiled Display Topology' block is selected and expanded in the main area. The block title is 'Tiled Display Topology Block' with a 'Delete Block' button. The configuration options are as follows:

Single Physical Device	<input checked="" type="radio"/>
Bezel Information Available	<input type="radio"/>
General Behaviour	Can not be described
Specific Behaviour	Can not be described
Total number of Horizontal Tiles	1
Total number of Vertical Tiles	1
Horizontal Tile Location	1
Vertical Tile Location	1
Horizontal Size (pixel)	640
Vertical Size (line)	480
Pixel Multiplier	0
Top Bezel Size (pixel)	0
Bottom Bezel Size (pixel)	0
Right Bezel Size (pixel)	0
Left Bezel Size (pixel)	0
Tiled Display Vendor	LWR
Tiled Display Product Code	0
Tiled Display Serial Number	0

EDID Editor Window

7.9. Settings Menu

7.9.1. Status Tab

General information about the product is displayed in this tab: `#status #firmwareversion #label #deviceid`

- **Device name** (read-only), **Device label** (editable), **Part number** and **Serial number**,
- **Firmware versions**;
- **Hardware versions**,
- **Temperature** values, **Voltages**, **Operation** time.
- In **-R** suffixed models: PSU status can be seen in this tab (PSU1/PSU2: running / failed)

General	
Device name	MX2-24x24-DH-12DPI-A-R
MAC address	12:34:56:78:9a:bc
Device label	Noe MX2 <input type="button" value="Set"/>
Part number	91310064
Serial number	00006947
Firmware versions	
Firmware package	1.7.0b0
Core	1.7.0b3
Front panel	1.7.0b1
V10 I/O port	0.0.0b0
Control Panel	1.0.8b1
Built-in web	1.25.0b3
Filesystem	1.7.0b1
U-Boot	1.4.0b1
V20 I/O port	0.0.0b0
VPP RX	0.0.0b0
VPP TX	0.0.0b0
Hardware versions	
Motherboard	V11_AAA0
Temperatures	
Summary	All temperatures are OK.
CPU temperature	26.14 °C (25.19 °C min, 27.06 °C max)
Crosspoint #1 temperature	55 °C (55 °C min, 55 °C max)
Crosspoint #2 temperature	70 °C (70 °C min, 70 °C max)
Motherboard DCDC temperature	35 °C (33 °C min, 36 °C max)
Motherboard main temperature	42 °C (41 °C min, 44 °C max)
Voltages	
Summary	All voltages are OK.
CPU 5V	5.15 V (5.14 V min, 5.17 V max)
CPU 1.2V	1.2 V (1.19 V min, 1.2 V max)
Motherboard 3.3V	3.27 V (3.27 V min, 3.28 V max)
Main 12V	11.84 V (11.84 V min, 11.89 V max)
Operation	
Uptime	24 days 03:20:18
Power redundancy	
PSU 1	failed
PSU 2	running

Status Tab in the Settings Menu

7.9.2. Network Tab

Network-related settings are available on the tab. `#network #ipaddress #dhcp`

General	
Current IP address	172.24.5.21
Current subnet mask	255.255.0.0
Current gateway address	172.24.0.1
Obtain IP address automatically (DHCP, AutoIP)	<input checked="" type="checkbox"/>
Static IP address	192.168.0.101
Static subnet mask	255.255.255.0
Static gateway address	192.168.0.1
Enable LW2 protocol	<input checked="" type="checkbox"/>
Enable P#2 protocol	<input checked="" type="checkbox"/>
Apply changes	<input type="button" value="Apply changes"/> <input type="button" value="Cancel"/> <input type="button" value="Load factory defaults"/>

Network Tab in the Settings Menu

When dynamic IP address is used, the DHCP option is ticked; the IP settings of the matrix is shown in the first three lines. When static IP address is used, the DHCP option shall be unticked and the next three lines can be used to define the IP settings. The device can be controlled by LW3, LW2 protocols, or P#2 protocol.

ATTENTION! Connecting to the matrix via Ethernet and using LW2 port no. (default is 10001), the device accepts LW2 protocol commands. Using LW3 port no. (default is 6107) the device accepts LW3 protocol commands.

7.9.3. RS-232 Tab

The local RS-232 port settings are available on this tab. `#serial #rs-232 #rs232`

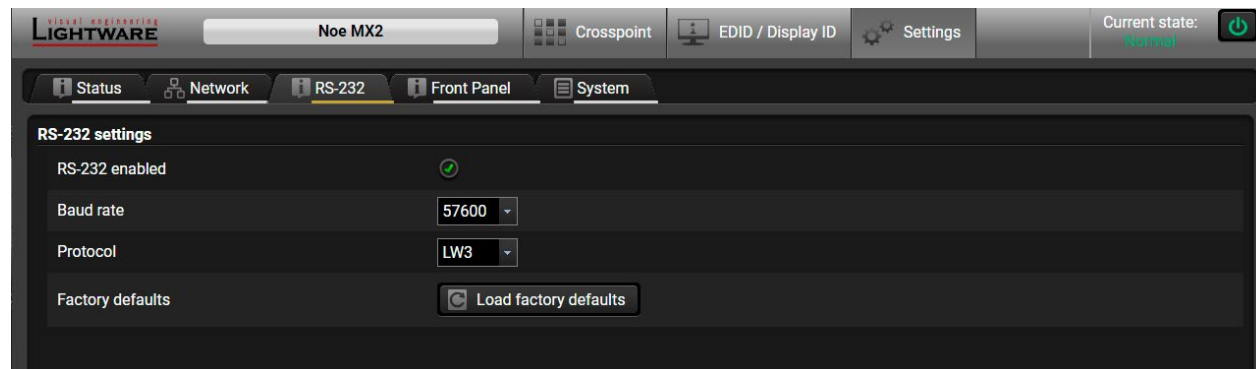

RS-232 Tab in the Settings Menu

7.9.4. Front Panel Tab

Certain settings in connection with the front panel LCD are available in the LDC as well.

- **LCD brightness:** the slider can be set to 0 contrary to the front panel menu. When the value is 0, the LCD is totally dark.
- **Lock front panel:** the same as the Control lock button on the front panel.
- **Enable buzzer:** enable/disable the built-in beeper.
- **Find my device:** the matrix buzzer beeps shortly three times.

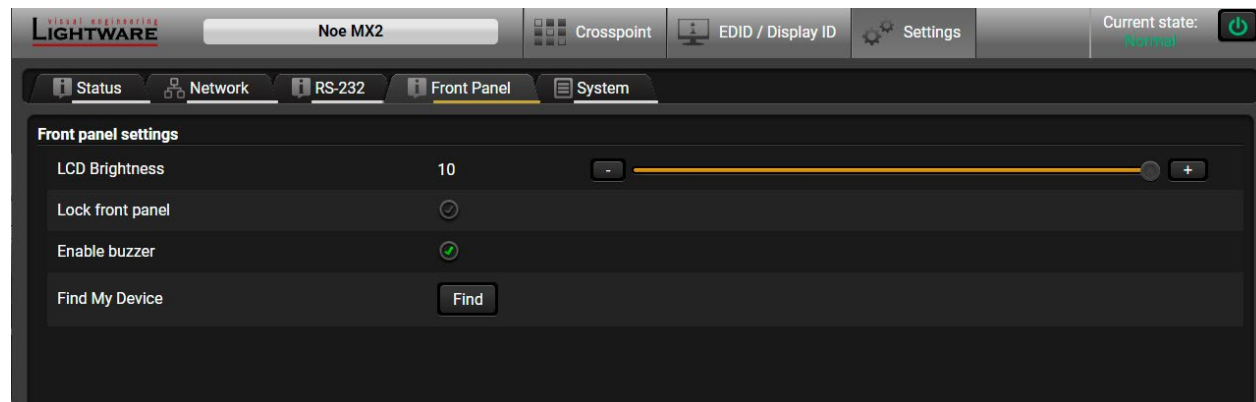

Front Panel Tab in the Settings Menu

7.9.5. System Tab

The following settings are available on this tab: `#factory #reset #reboot #restart #date #time`

- **Load factory default settings,**
- **Reboot the device,**
- **Set the time** (internal clock) of the matrix, which is used for logging events.

ATTENTION! The internal clock is supplied by a button cell when the device is switched off. If the set time is changed unintentionally or you met any weird behavior in connection with the internal clock, please contact support@lightware.com.

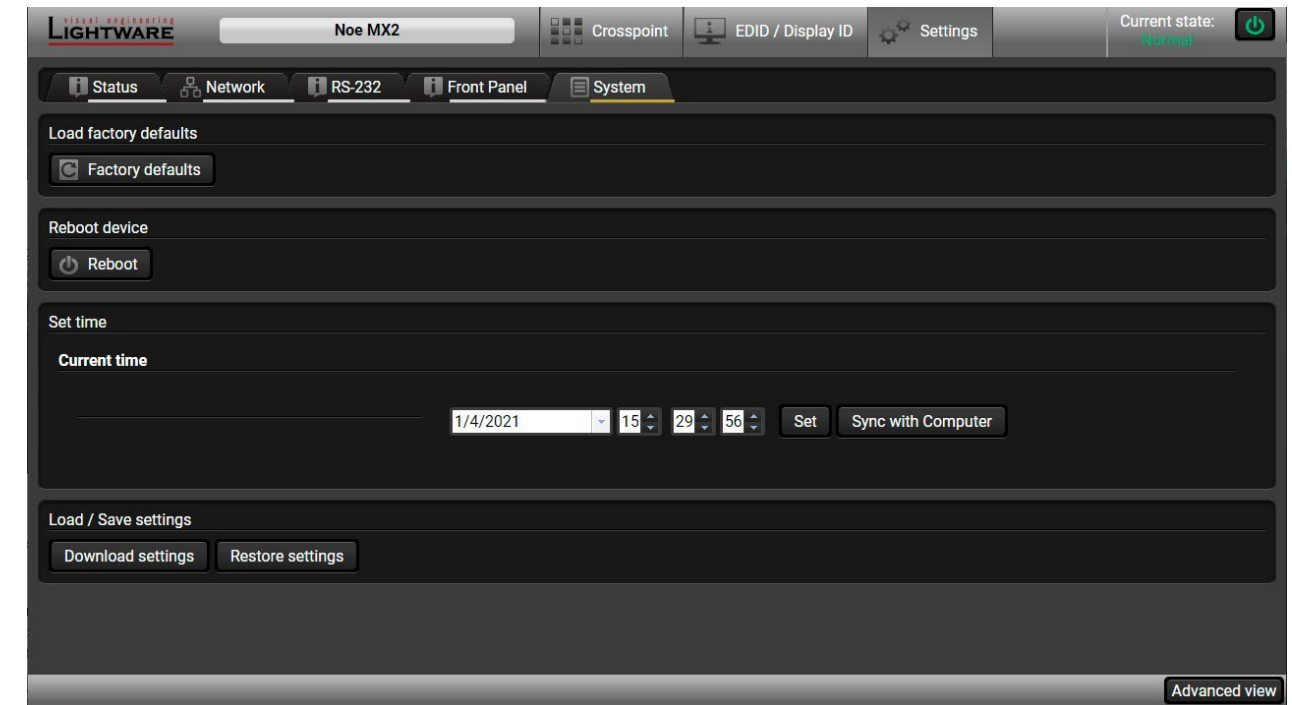

System Tab in the Settings Menu

7.10. Advanced View

Advanced view is the surface for displaying the LW3 protocol tree. Commands and specific parameters (which are not available on the graphical user interface of the LDC) can be run and set by the controlling tools. `#advancedview #terminal`

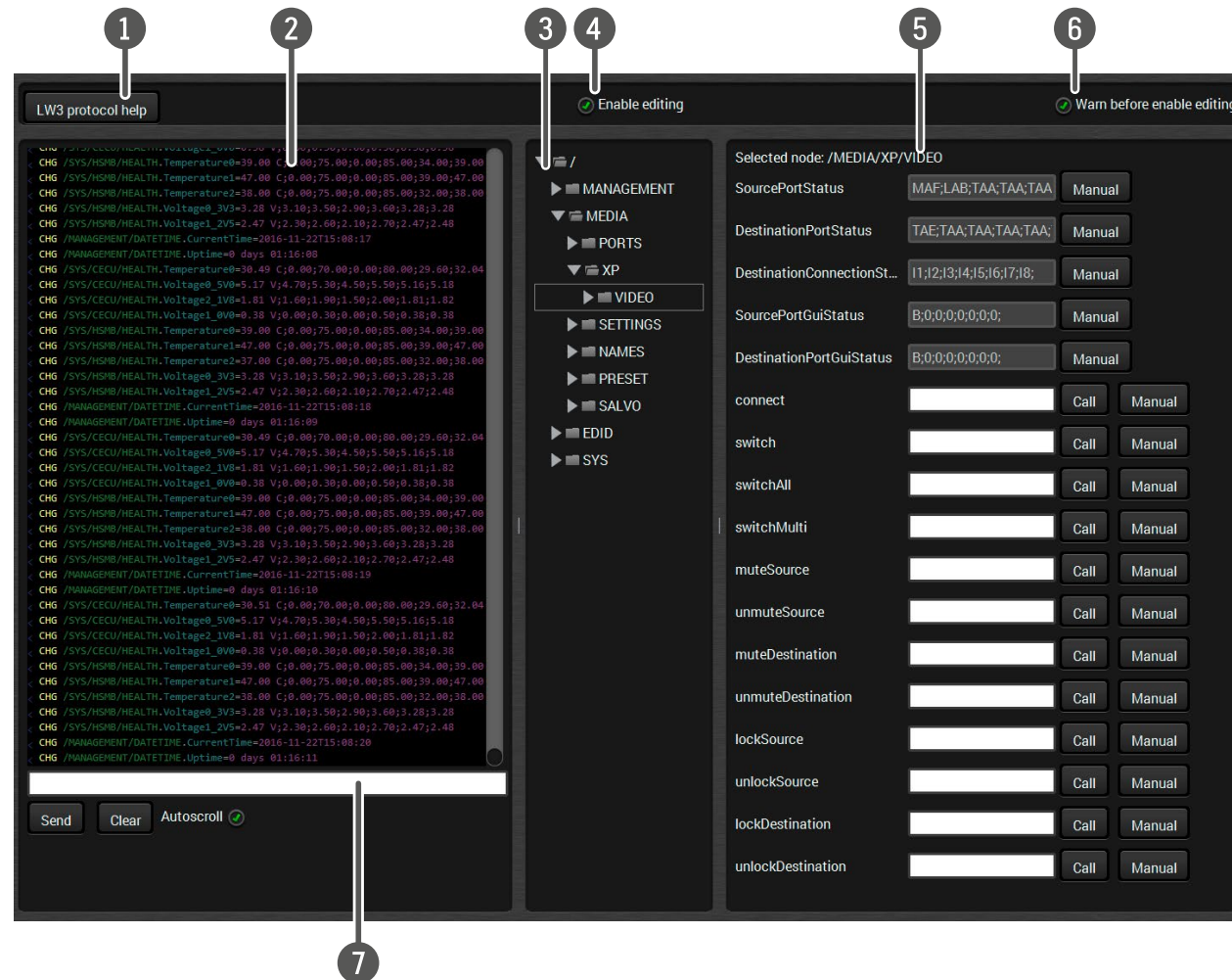

- LW3 protocol help** Pushing the button results in a help window opening, which describes the most important information about LW3 protocol commands in HTML format.
- Terminal window** Commands and responses with time and date are listed in this window. A sent command starts with a '`>`' character, while a received response starts with a '`<`' character. The color of each item depends on the type of the command and the response. The content of the window can be emptied with the **Clear** button. If the **Autoscroll** option is ticked, the list is scrolled automatically when a new line is added.
- Protocol tree** LW3 protocol tree; select an item to see its content.
- Edit mode** The default appearance is the read-only mode. If you want to modify the values or parameters, tick the option. You will be prompted to confirm your selection.
- Node list** Correspondent parameters and nodes are shown that are connected to the selected item in the protocol tree.
Manual button: Manual (short description) of the node can be called and displayed in the terminal window.
Set button: Saves the value/parameter typed in the textbox.
Call button: Calls the method, e.g. reloads factory default settings.
- Warning mode** If this is checked, a warning window pops up when you enable Edit mode.
- Command line** Type the desired command and execute it by the **Send** button. Clear all current commands and responses in the Terminal window with the **Clear** button.

8

LW2 Programmers' Reference

The device can be controlled through a reduced command set of LW2 protocol commands to ensure the compatibility with other Lightware products. The supported LW2 commands are described in this chapter.

- ▶ [PROTOCOL DESCRIPTION](#)
- ▶ [INSTRUCTIONS FOR THE TERMINAL APPLICATION USAGE](#)
- ▶ [ROUTER STATUS COMMANDS](#)
- ▶ [CROSSPOINT OPERATIONS](#)
- ▶ [PRESET HANDLING](#)
- ▶ [LW2 COMMANDS - QUICK SUMMARY](#)

8.1. Protocol Description

The protocol description hereinafter stands for Lightware protocol. The commands can be sent to the device in RAW format via the TCP/IP port no. 10001.

The receiver accepts commands surrounded by curly brackets - { } - and responds data surrounded by round brackets - () - only if a command was successfully executed. All input commands are converted to uppercase, but respond commands can contain upper and lower case letters as well.

Legend for Control Commands

Format	Explanation
<in>	Input number in 1 or 2 digit ASCII format (01, 5, 07, 16, etc.)
<out>	Output number in 1 or 2 digit ASCII format
<in/out>	Input or output port number in 1 or 2 digit ASCII format *
<in2>	Input number in 2 digit ASCII format (01, 02, 10, 12 etc.)
<out2>	Output number in 2 digit ASCII format (01, 02, 10, 12 etc.)
<in2/out2>	Input or output number in 2 digit ASCII format*
<loc>	Location number in 1, 2 or 3 digit ASCII format
<id>	ID number in 1 or 2 digit ASCII format
<id2>	ID number in 2 digit ASCII format
CrLf	Carriage return, Line feed (0x0D, 0x0A)
.	Space character (0x20)
→	Each command issued by the controller
←	Each response received from the router

* The command has the same arguments on the input ports and the output port, as well.

8.2. Instructions for the Terminal Application Usage

Terminal Application

The LW2 protocol commands can be applied to the receiver using a terminal application. You need to install one of them on your control device, for example **Putty** or **CLI**. *#terminal*

Establishing Connection

Follow the steps for establishing connection to the receiver:

- Step 1.** Connect the receiver to a LAN over Ethernet.
- Step 2.** Open the terminal application (e.g. Putty).
- Step 3.** Add the **IP address** of the device (default: 192.168.0.100) and the **port number (10001)**.
- Step 4.** Select the **Raw** connection type, and open the connection.

Once the terminal window is opened, you can enter the LW2 protocol commands, which are listed in the following sections.

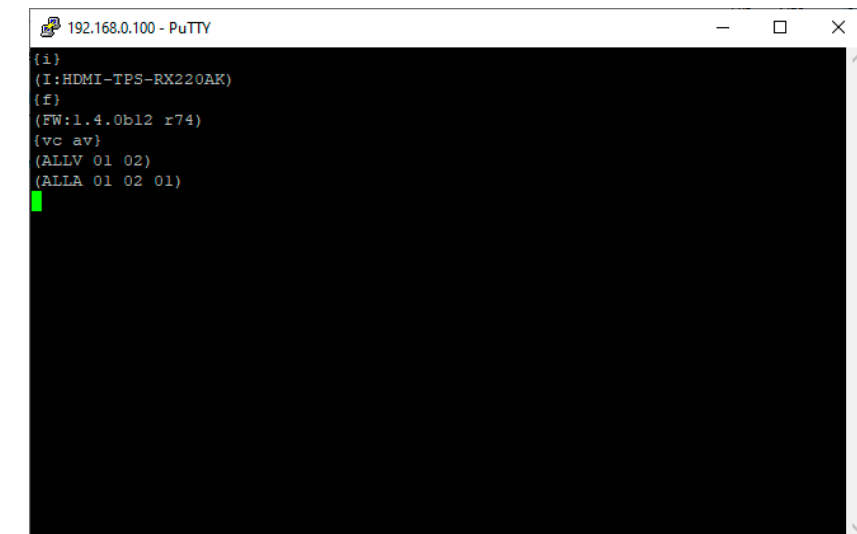
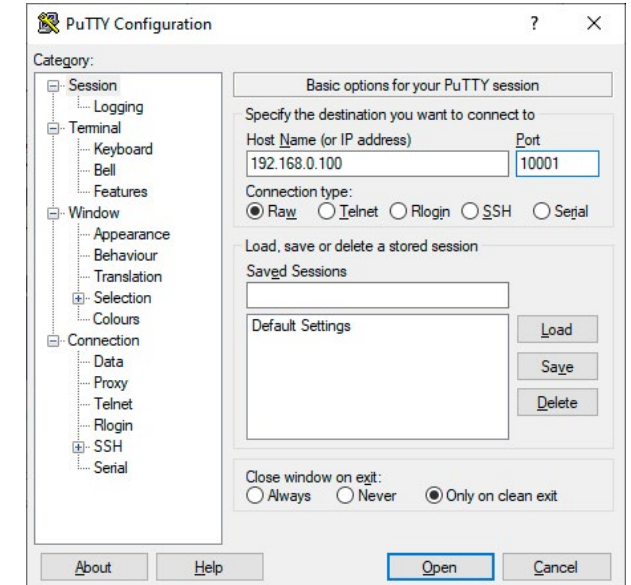

LW2 protocol command communication in a terminal window

8.3. Router Status Commands

8.3.1. List of All Available LW2 Commands

Command and Response

```
→ {lcmd}
← (LCMD# LCMD: List all commands)CrLf
← <LW2_commands>CrLf
← (LCMD END)CrLf
```

Example

```
→ {lcmd}
← (LCMD# LCMD: List all commands)
← (LCMD# PING: Always response PONG)
← (LCMD# CT: Compile time)
← ...
← (LCMD END)
```

8.3.2. Viewing Product Type

The device responds its name.

Command and Response

```
→ {}
← (!:<PRODUCT_TYPE>)CrLf
```

Example

```
→ {}
← (!:MX2-24x24-DH-12DPi-A-R)
```

8.3.3. Viewing Serial Number

The device responds its 8-digit serial number. *#serialnumber*

Command and Response

```
→ {S}
← (SN:<SERIAL_N>)CrLf
```

Example

```
→ {s}
← (SN:00006947)
```

8.3.4. Viewing the Installed Firmware

View the installed firmware package version. To view the firmware version of the controller, see the {FC} command. *#firmwareversion*

Command and Response

```
→ {f}
← (FW:<FW_VER>•<s>)CrLf
```

Parameters

<FW_VER> is the firmware package version. It is followed by <s> string, which may indicate special versions.

Example

```
→ {f}
← (FW:1.7.0b3)
```

8.3.5. Viewing CPU Firmware Compile Time

Returns the date when the microcontroller firmware was compiled.

Command and Response

```
→ {CT}
← (Complied: <DATE&TIME>)CrLf
```

Example

```
→ {ct}
← (Complied: May 11 2016 11:01:27)
```

8.3.6. Viewing Firmware of the Controller

Shows the firmware package versions of all installed controllers.

Command and Response

```
→ {FC}
← (CF•<DESC>)CrLf
← (CF•<DESC>)CrLf
← ...
← (CF•END)CrLf
```

Parameters

<FW_VER> is the firmware version. It is followed by <s> string, which may indicate special versions.

Example

```
→ {fc}
← (MX-CPU2 FW:1.4.1b1 r80)
← (SL END)
```

8.3.7. Viewing Installed Motherboard

Shows the hardware name and revision of the installed card.

Command and Response

```
→ {IS}
← (SL#•0•<MB_DESC>)CrLf
← (SL•END)CrLf
```

Example

```
→ {is}
← (SL# 0 MX2-8X8-HDMI20-AUDIO V11_AAA0)
← (SL END)
```

8.3.8. Viewing Crosspoint Size

Shows the physical crosspoint size.

Command and Response

```
→ {getsize•<layer>}
← (SIZE=<size>•<layer>)CrLf
```

Parameters

Identifier	Parameter description	Parameter values
<size>	Crosspoint size	<number_of_inputs>x<number_of_outputs>
<layer>	Signal type of the layer	See the previous section

Example

```
→ {GETSIZE}
← (SIZE=24x24)
```

The matrix reports that it has an 24x24 crosspoint.

8.3.9. Viewing Router's Health

Internal voltages and measured temperature values are shown.

Command and Response

```
→ {ST}
← (ST•<DESC>)CrLf
```

Example

```
→ {st}
← (ST CPU 3.3V 5.00V 3.00V 5.00V)
```

8.3.10. Querying Control Protocol (RS-232)

The device can be controlled with different control protocols. This command queries the active protocol of the currently used control interface.

Command and Response

```
→ {P_?}
← (CURRENT•PROTOCOL•=#<protocol>)CrLf
```

Parameters

Identifier	Parameter description	Parameter values
<protocol>	Control protocol	1: LW2 protocol 2: P#2 protocol

Example

```
→ {P_?}
← (CURRENT PROTOCOL = #1)
```

The device communicates with LW2 protocol. *#controlprotocol*

ATTENTION! Be aware that different control interfaces can use different protocols. E.g. the Ethernet interface can use the LW3 protocol, while the Serial interface uses P#2 protocol at the same time.

ATTENTION! The response shows only the active protocol for the interface that was used to send the command!

8.4. Crosspoint Operations

8.4.1. Switching an Input to an Output

Switching an input <in> to output <out>. Following commands with A, V, AV parameter value can take effect in multiple layers, according to their parameters. Depending on 'A' or 'V' it can change only the Audio or only the Video layer; or 'AV' changes both. *#crosspoint #switch*

Command and Response

```
→ {<in>@<out>•<layer>}
← (O<out2>•I<in2>•<layer>)CrLf
```

Parameters

Identifier	Parameter description	Parameter values
<layer>	Signal type of the layer	A: audio layer V: video layer AV: audio & video layer
<out>	Output port	01-04 (or 08)
<in>	Input port	I1-I8 0: Using the '0' (zero) value, the input will be disconnected and no signal will appear on the output

INFO: The <layer> parameter usually can be skipped for legacy purposes. In this case, the devices change all (Video & Audio) layers, but using status commands, it displays information about only the Video layer. Please use the AV option when available.

Example 1

```
→ {2@1 AV}
← (001 I02)
```

I2 audio and I2 video input ports are switched to O1 output port.

Example 2

```
→ {0@1}
← (001 I00)
```

ATTENTION! The response of this command does not show if the output is muted. To check the mute status, a separate query has to be used like {VC}. See the [Viewing the Connection of an Output Port](#) section. To achieve multiple switches executed together, see the [Batch Switching Outputs](#) section.

8.4.2. Switching an Input to All Outputs

Switch input <in> to all outputs.

Command and Response

```
→ {<in>@0}
← (I<in2>•ALL)CrLf
```

Example

```
→ {2@0}
← (I02 ALL)
```

8.4.3. Batch Switching Outputs

The device is capable of switching multiple outputs exactly at the same time. To do this, the normal switch commands have to be used. If the switch commands arrive at the device with less than 10 milliseconds delay, the commands are collected and changes the output connections together.

Required circumstances:

- Switch commands have this format: {<in>@<out>}{<in>@<out>}
- The delay between two '}' characters must be below 10 milliseconds
- No other command or junk character is allowed between switch commands
- Affected outputs must not be locked

If any of the above circumstances fail, then the commands will be processed separately and the output connections will change one by one.

ATTENTION! The delay timeout applies for the receiving time of characters. Please note that if LAN connection is used then the network may cause additional delays. This could result in batch switching failing to occur. The example below shows a command that resulted in batch switching:

One by one commands

```
→ {02@01 V}
← (001 I02)CrLf
→ {05@04 V}
← (004 I05)CrLf
```

Batch commands

```
→ {02@01}{05@04}
← (001 I02)CrLf
← (004 I05)CrLf
```

8.4.8. Unmuting Specified Output

Unmute the <out> output. *#unmute*

Command and Response

```
→ {+<out>}
← (OMT<out>)CrLf
```

Example

```
→ {+01}
← (OMT01)
```

INFO: Unmuting an output makes the previous connection active, as the crosspoint state has not been changed by the muting command, only the output was disabled.

8.4.9. Locking Specified Output

Locking an output port. Output's state cannot be changed until unlocking. *#lock*

Command and Response

```
→ {#><out>}
← (1LO<out?>)CrLf
```

Example

```
→ {#>01 A}
← (1L001 A)
```

8.4.10. Unlocking a Specified Output

Unlocking an output port. The connection on output can be changed.

Command and Response

```
→ {+<<out>}
← (OLO<out>)CrLf
```

Example

```
→ {+<01}
← (OLO01)
```

O1 video output port is unlocked.

INFO: The device issues the response above regardless of the previous state of the output (either it was locked or unlocked).

8.5. Preset Handling

8.5.1. Loading a Preset

Recall a saved preset. *#preset*

Command and Response

```
→ {%<preset>}
← (LPR<out>)CrLf
```

Example

```
→ {%Mtgroom1}
← (LPRMtgroom1)
```

Preset called "Mtgroom1" has been loaded and applied.

8.6. LW2 Commands - Quick Summary

Router Status Commands

List of All Available LW2 Commands

→ {lcmd}

Viewing Product Type

→ {i}

Viewing Serial Number

→ {S}

Viewing the Installed Firmware

→ {f}

Viewing CPU Firmware Compile Time

→ {CT}

Viewing Firmware of the Controller

→ {FC}

Viewing Installed Motherboard

→ {IS}

Viewing Crosspoint Size

→ {getsize•<layer>}

Viewing Router's Health

→ {ST}

Querying Control Protocol (RS-232)

→ {P_?}

Crosspoint Operations

Switching an Input to an Output

→ {<in>@<out>•<layer>}

Switching an Input to All Outputs

→ {<in>@0}

Viewing the Connection of an Output Port

→ {?<out>}

Viewing Connections of all Outputs

→ {VC•<layer>}

Viewing Mutes on all Outputs

→ {VM}

Muting Specified Output

→ {#<out>}

Unmuting Specified Output

→ {+<out>}

Locking Specified Output

→ {#><out>}

Unlocking a Specified Output

→ {+<<out>}

Preset Handling

Loading a Preset

→ {%<preset>}

9

LW3 Programmers' Reference

The device can be controlled through Lightware 3 (LW3) protocol commands to ensure the compatibility with other Lightware products. The supported LW3 commands are described in this chapter.

- ▶ [OVERVIEW](#)
- ▶ [INSTRUCTIONS FOR THE TERMINAL APPLICATION USAGE](#)
- ▶ [PROTOCOL RULES](#)
- ▶ [SYSTEM COMMANDS](#)
- ▶ [SWITCHING AND CROSSPOINT SETTINGS](#)
- ▶ [DISPLAYPORT INPUT SETTINGS](#)
- ▶ [AUDIO INPUT PORT SETTINGS](#)
- ▶ [VIDEO OUTPUT PORT SETTINGS \(HDMI AND DISPLAYPORT\)](#)
- ▶ [HDMI OUTPUT SETTINGS](#)
- ▶ [DISPLAYPORT OUTPUT SETTINGS](#)
- ▶ [AUDIO OUTPUT PORT SETTINGS](#)
- ▶ [PRESET HANDLING](#)
- ▶ [NETWORK SETTINGS](#)
- ▶ [EDID MANAGEMENT](#)
- ▶ [RS-232 PORT SETTINGS](#)
- ▶ [LW3 COMMANDS – QUICK SUMMARY](#)

9.1. Overview

The Lightware Protocol #3 (LW3) is implemented in almost all new Lightware devices (matrix switchers, signal extenders and distribution amplifiers) since 2012. The protocol is ASCII-based and all commands are terminated with a carriage return (Cr, '\r') and line feed (Lf, '\n') pair. It is organized as a tree structure that provides outstanding flexibility and user-friendly handling with 'nodes', 'properties' and 'methods'. The **Advanced View** of the Lightware Device Controller software is the perfect tool for browsing and learning how the LW3 protocol can be used in practice.

9.2. Instructions for the Terminal Application Usage

Terminal Application

The LW3 protocol commands can be applied to the switcher using a terminal application. You need to install one of them to your control device, for example **Putty** or **CLI**. `#terminal`

Establishing Connection

Follow the steps for establishing connection to the receiver:

- Step 1.** Connect the receiver to a LAN over Ethernet.
- Step 2.** Open the terminal application (e.g. Putty).
- Step 3.** Add the **IP address** of the device (default: DHCP) and the **port number (6107)**.
- Step 4.** Select the **Raw** connection type, and open the connection.

Once the terminal window is opened, you can enter the LW3 protocol commands, which are listed in the following sections.

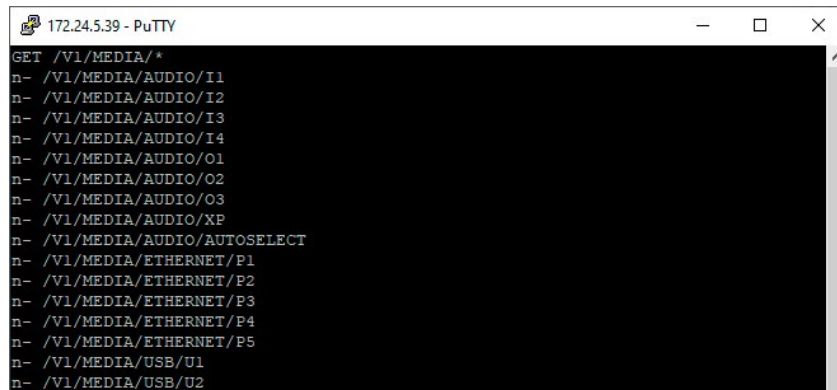
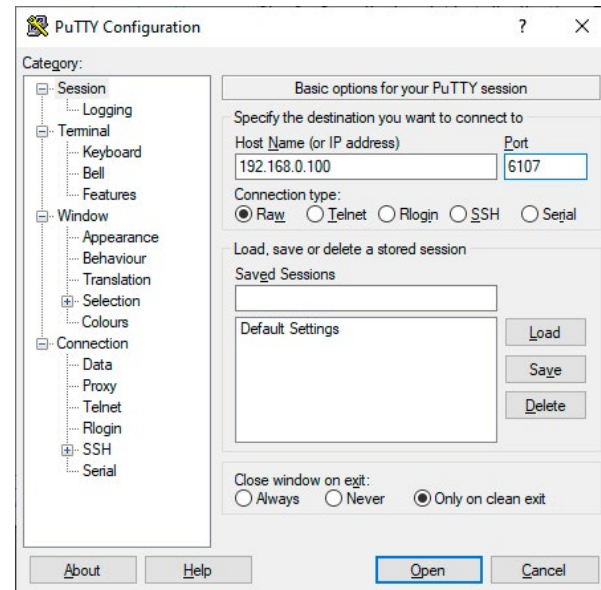

LW3 protocol command communication in a terminal window

9.3. Protocol Rules

9.3.1. LW3 Tree Structure and Command Structure (examples)

9.3.2. General Rules

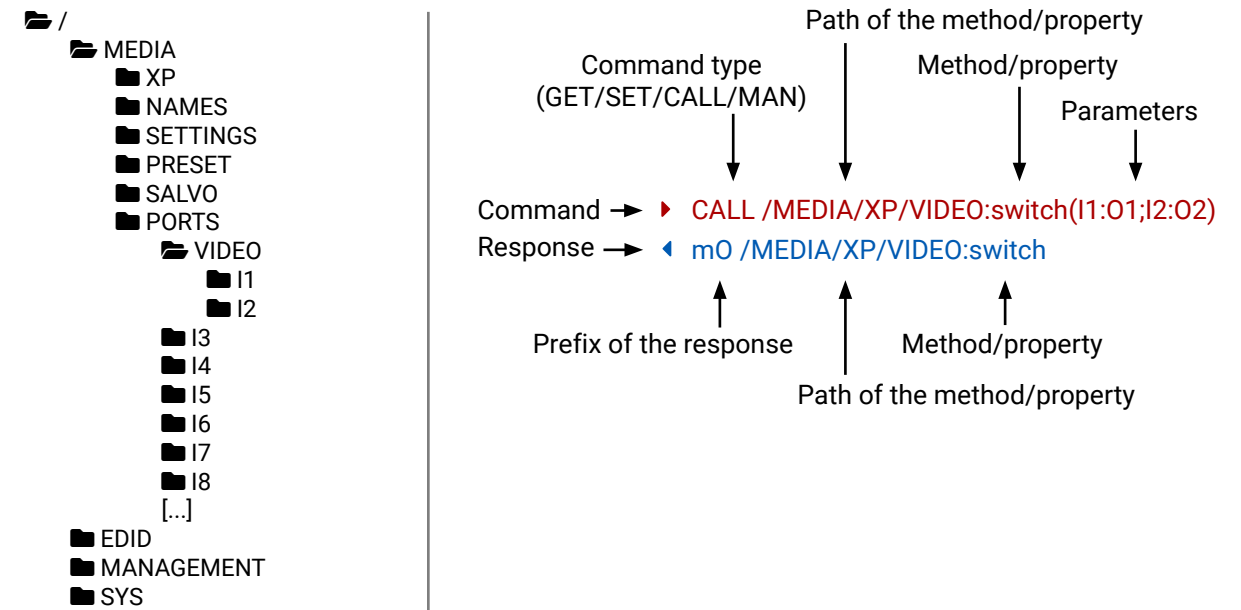

- All names and parameters are case-sensitive.
- The nodes are separated by a slash ('/') character.
- The node name can contain the elements of the English alphabet and numbers.
- Use the TCP port no. 6107 when using LW3 protocol over Ethernet.
- When a command is issued by the device, the received response cannot be processed by the CPU.
- The node paths describe the exact location of the node, listing each parent node up to the root.
- The length of a line (command/response, command type / prefix, path, method/property and parameters together) can be max. 800 bytes.
- The command lines have to be closed by Carriage return and Line Feed (CrLf)

9.3.3. Legend for the Control Commands

Command and Response – Example

- ▶ GET /V1/MEDIA/VIDEO/I2.SignalPresent
- ◀ pr /V1/MEDIA/VIDEO/I2.SignalPresent=<signal_present>

Format	Description
<in>	Input port number
<out>	Output port number
<port>	Input or output port number
<loc>	Location number
<parameter>	Specific property defined and described in the command
<expression>	Batched parameters: the underline means that more expressions or parameters can be placed by using a semicolon, e.g. I2;I4;I5 or F27:E1;F47:E2
▶	Sent command
◀	Received response
.	Space character

Further, not listed <parameters> are defined at each command.

9.3.4. Command Types

GET command

The **GET** command can be used to get the child nodes, properties and methods of a specific node. It can also be used to get the value of a property. Use the dot character (.) when addressing a property:

- ▶ **GET /.SerialNumber**
- ◀ **pr /.SerialNumber=87654321**

GETALL command

The **GETALL** command can be used to get all child nodes, properties and methods of a node with one command.

- ▶ **GETALL /MEDIA/PORTS/VIDEO/I1/CEC**
- ◀ **pr /MEDIA/PORTS/VIDEO/I1/CEC.LastReceivedMessage=**
- ◀ **pr /MEDIA/PORTS/VIDEO/I1/CEC.LastSentCommandResult=ACK**
- ◀ **pw /MEDIA/PORTS/VIDEO/I1/CEC.OsdString=**
- ◀ **pw /MEDIA/PORTS/VIDEO/I1/CEC.Broadcast=false**
- ◀ **m- /MEDIA/PORTS/VIDEO/I1/CEC:factoryDefaults**
- ◀ **m- /MEDIA/PORTS/VIDEO/I1/CEC:send**
- ◀ **m- /MEDIA/PORTS/VIDEO/I1/CEC:sendHex**

SET command

The **SET** command can be used to modify the value of a property. Use the dot character (.) when addressing the property:

- ▶ **SET /MEDIA/PORTS/VIDEO/I1/SETTINGS.Conversion=OFF**
- ◀ **pw /MEDIA/PORTS/VIDEO/I1/SETTINGS.Conversion=OFF**

CALL command

A method can be invoked by the **CALL** command. Use the colon character (:) when addressing the method:

- ▶ **CALL /MEDIA/XP/VIDEO:switch(I1:O1)**
- ◀ **mO /MEDIA/XP/VIDEO:switch**

MAN command

The manual is a human readable text that describes the syntax and provides a hint on how to use the primitives. For every node, property and method in the tree there is a manual, type the **MAN** command to get the manual:

- ▶ **MAN /MEDIA/PORTS/VIDEO/I1/SETTINGS.EnablePower**
- ◀ **pm /MEDIA/PORTS/VIDEO/I1/SETTINGS.EnablePower [true|false] Enables or disables 3v3 powering on DP_PWR pin**

9.3.5. Prefix Summary

DEFINITION: The prefix is a 2-character long code that describes the type of the response.

The following prefixes are defined in the LW3 protocol:

Prefix	Description
n-	a node
nE	an error for a node
nm	a manual for a node
ns	a child node of a node
pr	a read-only property
pw	read-write property
pE	an error for the property
pm	a manual for the property
m-	a method
mO	a response after a successful method execution
mF	a response after a failed method execution
mE	an error for a method
mm	a manual for a method

9.3.6. Error Messages

There are several error messages defined in the LW3 protocol, all of them have a unique error number.

- ▶ `CALL /MEDIA/XP/VIDEO:switch(IA:01)`
- ◀ `mE /MEDIA/XP/VIDEO:switch %E004:Invalid value`

9.3.7. Escaping

DEFINITION: An escape sequence is a sequence of characters that does not represent itself when used inside a character or string literal, but is translated into another character or a sequence of characters.

Property values and method parameters can contain characters that are used as control characters in the protocol. They must be escaped. The escape character is the backslash ('\'), and escaping means injecting a backslash before the character that should be escaped (like in C language).

Control characters are the following: \ { } # % () \r \n \t

The **original** message: `CALL /MEDIA/UART/P1:sendMessage(Set(01))`

The **escaped** message: `CALL /MEDIA/UART/P1:sendMessage(Set\\(01\\))`

9.3.8. Signature

DEFINITION: The signature is a four-digit-long hexadecimal value that can be optionally placed before every command to keep a command and the corresponding responses together as a group.

Each line is terminated with carriage return (Cr, '\r') and line feed (Lf, '\n') characters. In several cases the number of the lines in the response cannot be determined in advance, e.g. the client intends to wait for the whole response, and also wants to be sure that the received lines belong together and to the same command. For this purpose a special feature, the 'signature', can be used. In these cases, the response to that particular command will also be preceded by the signature, and the corresponding lines will be between brackets:

```
▶ 1700#GET /EDID.*
◀ {1700
◀ pr /EDID.EdidStatus=F89:E1;D1:E2;D1:E3;D1:E4;F89:E5
◀ pr /EDID.Features=DisplayID;
◀ m- /EDID:copy
◀ m- /EDID:delete
◀ m- /EDID:reset
◀ m- /EDID:switch
◀ m- /EDID:switchAll
◀ }
```

INFO: The lines of the signature are also Cr and Lf terminated.

9.3.9. Subscription

DEFINITION: Subscribing to a node means that the user will get a notification if any of the properties of the node is changed.

A user can subscribe to any node. These notifications are asynchronous messages, and they are useful to keep the client application up to date without receiving any unwanted information. When the user does not want to be informed about the changes anymore, they can simply unsubscribe from the node.

ATTENTION! The subscriptions are handled separately for connections. Hence, if the connection is terminated, all registered subscriptions are deleted. After closing a connection, the subscribe command has to be sent in order to get the notifications about the changes on that connection.

Subscribe to a Node

- ▶ `OPEN /MEDIA/VIDEO`
- ◀ `o- /MEDIA/VIDEO`

Unsubscribe from a Node

- ▶ `CLOSE /MEDIA/VIDEO`
- ◀ `c- /MEDIA/VIDEO`

Subscribe to Multiple Nodes

- ▶ `OPEN /MEDIA/VIDEO/*`
- ◀ `o- /MEDIA/VIDEO/*`

Unsubscribe from Multiple Nodes

- ▶ `CLOSE /MEDIA/VIDEO/*`
- ◀ `c- /MEDIA/VIDEO/*`

Get the Active Subscriptions

- ▶ `OPEN`
- ◀ `o- /MEDIA/VIDEO`
- ◀ `o- /EDID`
- ◀ `o- /DISCOVERY`

9.3.10. Notifications about the Changes of the Properties

When the value of a property is changed and the user is subscribed to the node that the property belongs to, an asynchronous notification is generated. This notification is called the 'change message'. The format of such a message is very similar to the response for the **GET** command:

◀ CHG /EDID.EdidStatus=F48:E1

A Short Example of How to Use the Subscription

There are two independent users controlling the device through two independent connections (**Connection #1** and **Connection #2**). The events in the rows occur after each other.

▶ OPEN /MEDIA/AUDIO/O3 ◀ o- /MEDIA/AUDIO/O3 ▶ GET /MEDIA/AUDIO/O3.VolumePercent ◀ pm /MEDIA/AUDIO/O3.VolumePercent=100.00	connection #1
▶ GET /MEDIA/AUDIO/O3.VolumePercent ◀ pw /MEDIA/AUDIO/O3.VolumePercent=100.00 ◀ SET /MEDIA/AUDIO/O3.VolumePercent=50.00 ◀ pw /MEDIA/AUDIO/O3.VolumePercent=50.00	connection #2
◀ CHG /MEDIA/AUDIO/O3.VolumePercent=50.00	connection #1

The first user (**Connection #1**) set a subscription to a node. Later, the other user (**Connection #2**) made a change, and thanks to the subscription, the first user got a notification about the change.

9.3.11. Legend for the Control Commands

Format	Description
<in>	Input port number
<out>	Output port number
<port>	Input or output port number
<loc>	Location number
<parameter>	Variable, which is defined and described in the command
<expression>	Batched parameters: the underline means that more expressions or parameters can be placed by using a semicolon, e.g. I2;I4;I5 or F27:E1;F47:E2
▶	Sent command
◀	Received response
.	Space character

9.4. System Commands

9.4.1. Querying the Product Name

The name of the product is a read-only parameter and cannot be modified.

Command and Response

▶ GET /.ProductName
◀ pr /.ProductName=<Product_name>

Parameters

The <Product_name> is the type of the device: read-only parameter and cannot be modified.

Example

▶ GET /.ProductName
◀ pr /.ProductName=MX2-24x24-DH-12DPi-R

9.4.2. Setting the Device Label

This property can be changed to a custom text. The default format of the device label is the following:
LW_<product_name>_<serial_no>

ATTENTION! This writable parameter is not the same as the **ProductName** parameter.

Command and Response #label #devicelabel

▶ SET /MANAGEMENT/UID/DeviceLabel=<Custom_name>
◀ pw /MANAGEMENT/UID/DeviceLabel=<Custom_name>

Parameters

The <Custom_name> may consist of ASCII characters and can be 32 characters long. Longer names are truncated.

Example

▶ SET /MANAGEMENT/UID.DeviceLabel=MX2_Control_room
◀ pw /MANAGEMENT/UID.DeviceLabel=MX2_Control_room

9.4.3. Querying the Serial Number

Command and Response

▶ GET /.SerialNumber
◀ pr /.SerialNumber=<serial_nr>

Example

▶ GET /.SerialNumber
◀ pr /.SerialNumber=87654321

9.5.2. Switching an Input to an Output

Command and Response

- ▶ CALL·/MEDIA/XP/VIDEO:switch(<in>:<out>)
- ◀ mO·/MEDIA/XP/VIDEO:switch=OK

Example

- ▶ CALL /MEDIA/XP/VIDEO:switch(I4:O1)
- ◀ mO /MEDIA/XP/VIDEO:switch=OK

9.5.3. Disconnecting the Output from any Input

Command and Response

- ▶ CALL·/MEDIA/XP/VIDEO:switch(0:<out>)
- ◀ mO·/MEDIA/XP/VIDEO:switch=OK

Example

- ▶ CALL /MEDIA/XP/VIDEO:switch(0:O1)
- ◀ mO /MEDIA/XP/VIDEO:switch=OK

9.5.4. Switching an Input to All Outputs

Command and Response

- ▶ CALL·/MEDIA/XP/VIDEO:switchAll(<in>)
- ◀ mO·/MEDIA/XP/VIDEO:switchAll=OK

Example

- ▶ CALL /MEDIA/XP/VIDEO:switchAll(I1)
- ◀ mO /MEDIA/XP/VIDEO:switchAll=OK

TIPS AND TRICKS: All output ports can be disconnected by the '0' value:
CALL /MEDIA/XP/VIDEO:switchAll(0).

9.5.5. Multiple Switching

The whole crosspoint can be set by sending one command as follows.

Command and Response

- ▶ CALL·/MEDIA/XP/VIDEO:switchMulti(<out1_source>;<out2_source>;...;<out8_source>)
- ◀ mO·/MEDIA/XP/VIDEO:switchMulti=OK

The source is not required to be set on all output ports (see the **Example2**).

Parameters

The <out#_source> parameters mean the output ports one after the other. The value of the parameter shows the input port switched to the given output port.

Example1

- ▶ CALL /MEDIA/XP/VIDEO:switchMulti(I1;I2;I3;I4;I5;I6;I7;I8)
- ◀ mO /MEDIA/XP/VIDEO:switchMulti=OK

Example2

- ▶ CALL /MEDIA/XP/VIDEO:switchMulti(I1;I2;;;I5)
- ◀ mO /MEDIA/XP/VIDEO:switchMulti=OK

9.5.6. Video Input Port Settings (HDMI and DisplayPort)

9.5.7. Setting the HDCP State

This setting allows to send non-encrypted content to a non-HDCP compliant display. See more information in the [HDCP Management](#) section.

Command and Response *#hdcp*

- ▶ SET·/MEDIA/PORTS/VIDEO/<in>/SETTINGS.HdcpVersion=<HDCP_ver>
- ◀ pw·/MEDIA/PORTS/VIDEO/<in>/SETTINGS.HdcpVersion=<HDCP_ver>

Parameters

Identifier	Parameter description	Parameter values
<HDCP_ver>	HDCP setting	0: HDCP encryption is disabled 1 *: HDCP 1.4 encryption is enabled 2: HDCP 2.2 is enabled 3: High value mode: Any HDCP version is allowed on the input, but the incoming signal is always internally converted up to HDCP 2.2, thus the signal cannot be switched to HDCP 1.4 sinks.

*The availability of this setting depends on the hardware version of the input board (V1x_) of the selected HDMI port, only in MX2-8x8-HDMI20 model. The hardware version can be found in the [Status Tab](#) in the LDC or in the [System Settings Menu](#), [Device Info](#) submenu in the LCD.

Example

- ▶ SET /MEDIA/PORTS/VIDEO/I1/SETTINGS.HdcpVersion=3
- ◀ pw /MEDIA/PORTS/VIDEO/I1/SETTINGS.HdcpVersion=3

9.5.8. Muting an Input Port

Command and Response *#mute*

- ▶ CALL·/MEDIA/XP/VIDEO:muteSource(<in>)
- ◀ mO·/MEDIA/XP/VIDEO:muteSource=OK

Example

- ▶ CALL /MEDIA/XP/VIDEO:muteSource(I1)
- ◀ mO /MEDIA/XP/VIDEO:muteSource=OK

9.5.9. Unmuting an Input Port

Command and Response *#unmute*

- ▶ CALL·/MEDIA/XP/VIDEO:unmuteSource(<in>)
- ◀ mO·/MEDIA/XP/VIDEO:unmuteSource=OK

Example

- ▶ CALL /MEDIA/XP/VIDEO:unmuteSource(I1;I3)
- ◀ mO /MEDIA/XP/VIDEO:unmuteSource=OK

9.5.10. Locking an Input Port

Command and Response *#lock*

- ▶ CALL·/MEDIA/XP/VIDEO:lockSource(<in>)
- ◀ mO·/MEDIA/XP/VIDEO:lockSource=OK

Example

- ▶ CALL /MEDIA/XP/VIDEO:lockSource(I1;I2;I3)
- ◀ mO /MEDIA/XP/VIDEO:lockSource=OK

9.5.11. Unlocking an Input Port

Command and Response *#unlock*

- ▶ CALL·/MEDIA/XP/VIDEO:unlockSource(<in>)
- ◀ mO·/MEDIA/XP/VIDEO:unlockSource=OK

Example

- ▶ CALL /MEDIA/XP/VIDEO:unlockSource(I1;I3)
- ◀ mO /MEDIA/XP/VIDEO:unlockSource=OK

■ INFO: The current setting can be queried by using the [GET command](#).

9.5.12. Querying the Status of the Source Ports

Command and Response #status

- ▶ GET-/MEDIA/XP/VIDEO.SourcePortStatus
- ◀ pr-/MEDIA/XP/VIDEO.SourcePortStatus=<in1_state>;<in2_state>;...;<in_n_state>

The responses contain one letter and a 1 byte long HEX code showing the current state of the input ports.

Example

- ▶ GET /MEDIA/XP/VIDEO.SourcePortStatus
- ◀ pr /MEDIA/XP/VIDEO.SourcePortStatus=TEF;TAA;TAA;TAA;TAA;TAA;TAA;TAA

Parameters

Letter (Character 1)		
	Mute state	Lock state
T	Unmuted	Unlocked
L	Unmuted	Locked
M	Muted	Unlocked
U	Muted	Locked

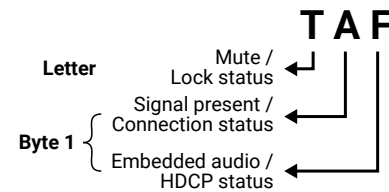

	Byte 1			
	Character 2		Character 3	
	BIT 7-6	BIT 5-4	BIT 3-2	BIT 1-0
	Embedded audio status	HDCP status	Signal present status	Connection status
0 0	Unknown			
0 1	Reserved			
1 0	No embedded audio	Not encrypted	No signal	Not connected
1 1	Embedded audio presents	Encrypted	Signal presents	Connected

Example and Explanation (TEF)

T	E		F	
Unlocked, Unmuted	1 1	1 0	1 1	1 1
	Embedded audio presents	Not encrypted	Signal presents	Connected

The Most Common Received Port Status Responses

TAA	T	A		A	
	Unlocked, Unmuted	1 0	1 0	1 0	1 0
	No embedded audio	Not encrypted	No signal	Not connected	

TAB	T	A		B	
	Unlocked, Unmuted	1 0	1 0	1 0	1 1
	No embedded audio	Not encrypted	No signal	Connected	

TAF	T	A		F	
	Unlocked, Unmuted	1 0	1 0	1 1	1 1
	No embedded audio	Not encrypted	Signal presents	Connected	

TEF	T	E		F	
	Unlocked, Unmuted	1 1	1 0	1 1	1 1
	Embedded audio presents	Not encrypted	Signal presents	Connected	

TBF	T	B		F	
	Unlocked, Unmuted	1 0	1 1	1 1	1 1
	No embedded audio	Encrypted	Signal presents	Connected	

TFF	T	F		F	
	Unlocked, Unmuted	1 1	1 1	1 1	1 1
	Embedded audio presents	Encrypted	Signal presents	Connected	

9.5.13. Setting the Audio Mode

Command and Response *#audio #analogaudio*

- ▶ SET·/MEDIA/PORTS/VIDEO/<in>/EMBEDEDAUDIO.AudioMode=<audio_mode>
- ◀ pw·/MEDIA/PORTS/VIDEO/<in>/EMBEDEDAUDIO.AudioMode=<audio_mode>

Parameters

Identifier	Parameter description	Parameter values
<audio_mode>	The current audio mode	OFF : no audio in the video stream HDMI : the original audio is embedded in the video stream ANALOG * : the analog audio of the input port is embedded in the video stream *Analog audio properties appear only in -Audio suffixed models, where there is an analog audio port beside the HDMI port.

Example

- ▶ SET /MEDIA/PORTS/VIDEO/I1/EMBEDEDAUDIO.AudioMode=OFF
- ◀ pw /MEDIA/PORTS/VIDEO/I1/EMBEDEDAUDIO.AudioMode=OFF

INFO: In case of **-A** or **-Audio** suffixed models, modifying the /MEDIA/PORTS/VIDEO/<in>/EMBEDEDAUDIO.AudioMode=<audio_mode> property will change the /MEDIA/PORTS/VIDEO/<in>/ANALOGAUDIO.AudioMode=<audio_mode> property.

9.5.14. Sending CEC Commands Towards the Source

INFO: The hidden first 2 bits of the CEC command are static (always 04), they refer to the logical address of the sender and the addressee. **0**: sender is a **TV**; **4**: the addressee is the **Playback Device 1**.

9.5.14.1. Sending an OSD String

Sending the OSD string consists of two steps. First, set the CEC.OsdString property with the desired text, after that, call the CEC.send(set_osd) method. *#cec*

Step 1 – Setting the CEC.OsdString Property

Command and Response

- ▶ SET·/MEDIA/PORTS/<in>/CEC.OsdString=<text>
- ◀ pw·/MEDIA/PORTS/<in>/CEC.OsdString=<text>

The following characters are allowed as <text> parameter: Letters (A-Z) and (a-z), hyphen (-), underscore (_), numbers (0-9), and dot (.). Max length: 14 characters.

Example

- ▶ SET /MEDIA/PORTS/VIDEO/I1/CEC.OsdString=Lightware
- ◀ pw /MEDIA/PORTS/VIDEO/I1/CEC.OsdString=Lightware

Step 2 – Calling the CEC.send(set_osd) method

Command and Response

- ▶ CALL·/MEDIA/PORTS/VIDEO/<in>/CEC:send(set_osd)
- ◀ m0·/MEDIA/PORTS/VIDEO/<in>/CEC:send=OK

Example

- ▶ CALL /MEDIA/PORTS/VIDEO/I1/CEC:send(set_osd)
- ◀ m0 /MEDIA/PORTS/VIDEO/I1/CEC:send=OK

9.5.14.2. Sending a CEC Command in Text Format

Command and Response

- ▶ CALL·/MEDIA/PORTS/VIDEO/<in>/CEC:send(<command>)
- ◀ m0·/MEDIA/PORTS/VIDEO/<in>/CEC:send=OK

Example

- ▶ CALL /MEDIA/PORTS/VIDEO/I1/CEC:send(power_on)
- ◀ m0 /MEDIA/PORTS/VIDEO/I1/CEC:send=OK

The following are accepted as <command>:

image_view_on	standby	ok	back	up
down	left	right	root_menu	setup_menu
contents_menu	favorite_menu	media_top_menu	media_context_menu	number_0
number_1	number_2	number_3	number_4	number_5
number_6	number_7	number_8	number_9	dot
enter	clear	channel_up	channel_down	sound_select
input_select	display_info	power_legacy	page_up	page_down
volume_up	volume_down	mute_toggle	mute	unmute
play	stop	pause	record	rewind
fast_forward	eject	skip_forward	skip_backward	3d_mode
stop_record	pause_record	play_forward	play_reverse	select_next_media
select_media_1	select_media_2	select_media_3	select_media_4	select_media_5
power_toggle	power_on	power_off	stop_function	f1
f2	f3	f4		

9.5.14.3. Sending a CEC Command in Hexadecimal Format

Command and Response

- ▶ CALL /MEDIA/PORTS/VIDEO/<in>/CEC:sendHex(<hex_command>)
- ◀ mO /MEDIA/PORTS/VIDEO/<in>/CEC:sendHex=OK

Accepted <hex_command> can be max. 30 characters (15 bytes) long in hexadecimal format.

Example

- ▶ CALL /MEDIA/PORTS/VIDEO/I1/CEC:sendHex(87 00 E0 91)
- ◀ mO /MEDIA/PORTS/VIDEO/I1/CEC:sendHex=OK

9.6. DisplayPort Input Settings

The current setting can be queried by using the [GET command](#).

DIFFERENCE: DisplayPort settings are available in certain models, -D letter in the model name refers to that (see the [Model Comparison](#) table).

9.6.1. Setting the Maximum Lane Number

Command and Response

- ▶ SET /MEDIA/PORTS/VIDEO/<in>/SETTINGS.DpMaxLaneCount=<lane>
- ◀ pw /MEDIA/PORTS/VIDEO/<in>/SETTINGS.DpMaxLaneCount=<lane>

Parameters

Identifier	Parameter description	Parameter values
<lane>	DisplayPort data transmission proceeds through the lanes. This defines the maximum number of lanes used.	1: One lane is able to transmit 5.4 Gbps of data. 2: Two lanes are able to transmit 10.8 Gbps of data. 4: Four lanes are able to transmit 21.6 Gbps of data.

Example

- ▶ SET /MEDIA/PORTS/VIDEO/I2/SETTINGS.DpMaxLaneCount=4
- ◀ pw /MEDIA/PORTS/VIDEO/I2/SETTINGS.DpMaxLaneCount=4

9.6.2. Enabling DP Power

This property allows to provide 1.5W (500mA @ 3.3W) power on DP_PWR pin. The default value is true.

Command and Response

#dppower

- ▶ SET /MEDIA/PORTS/VIDEO/<out>/SETTINGS.EnablePower=<enable_power>
- ◀ pw /MEDIA/PORTS/VIDEO/<out>/SETTINGS.EnablePower=<enable_power>

Parameters

<enable_power> **true:** The matrix sends 1.5W power on the chosen port.
false: The matrix does not provide any power on the chosen port.

Example

- ▶ SET /MEDIA/PORTS/VIDEO/O1/SETTINGS.EnablePower=true
- ◀ pw /MEDIA/PORTS/VIDEO/O1/SETTINGS.EnablePower=true

9.6.3. Setting the Maximum Link Data Rate

Command and Response

- ▶ SET /MEDIA/PORTS/VIDEO/<in>/SETTINGS.DpMaxLinkRate=<data_rate>
- ◀ pw /MEDIA/PORTS/VIDEO/<in>/SETTINGS.DpMaxLinkRate=<data_rate>

Parameters

Identifier	Parameter description	Parameter values
<data_rate>	The maximum data rate per lane.	RBR: Reduced Bit Rate uses 1.62 Gbps bandwidth. HBR: High Bit Rate uses 2.70 Gbps bandwidth. HBR2: High Bit Rate2 uses 5.40 Gbps bandwidth.

Example

- ▶ SET /MEDIA/PORTS/VIDEO/I1/SETTINGS.DpMaxLinkRate=HBR2
- ◀ pw /MEDIA/PORTS/VIDEO/I1/SETTINGS.DpMaxLinkRate=HBR2

9.6.4. Enabling the Test Pattern

Command and Response #testpattern #nosyncscreen

- ▶ SET /MEDIA/PORTS/VIDEO/<in>/SETTINGS.TpgMode=<tpg_status>
- ◀ pw /MEDIA/PORTS/VIDEO/<in>/SETTINGS.TpgMode=<tpg_status>

Parameters

Identifier	Parameter description	Parameter values
<tpg_status>	The testpattern is enabled or disabled.	0: The testpattern is disabled. 1: The testpattern is enabled.

Example

- ▶ SET /MEDIA/PORTS/VIDEO/I2/SETTINGS.TpgMode=1
- ◀ pw /MEDIA/PORTS/VIDEO/I2/SETTINGS.TpgMode=1

9.6.5. Setting the Conversion Mode

INFO: DisplayPort signals over 18Gbps will be converted down by either truncating bit depth or by converting RGB signal to YCbCr 4:2:2 12-bit signal based on user selection. The second option will not reduce the color depth, instead it results in loss of chroma information.

Command and Response *#colorspace*

- ▶ SET /MEDIA/PORTS/VIDEO/<in>/SETTINGS.Conversion=<conversion_mode>
- ◀ pw /MEDIA/PORTS/VIDEO/<in>/SETTINGS.Conversion=<conversion_mode>

Parameters

Identifier	Parameter description	Parameter values
<conv_mode>	Conversion mode	OFF: The video signal is transmitted without any changing. 422: The video converter subsamples the 4:4:4 signal to 4:2:2. 420: The video converter subsamples the 4:4:4 signal to 4:2:0.

Example

- ▶ SET /MEDIA/PORTS/VIDEO/I1/SETTINGS.Conversion=OFF
- ◀ pw /MEDIA/PORTS/VIDEO/I1/SETTINGS.Conversion=OFF

9.6.6. Restarting Link Training

This method is equal with pulling the DP connector out and plugging it in again.

Command and Response *#linktraining*

- ▶ CALL /MEDIA/PORTS/VIDEO/<in>/SETTINGS:dpLinkTrain()
- ◀ mO /MEDIA/PORTS/VIDEO/<in>/SETTINGS:dpLinkTrain=

Example

- ▶ CALL /MEDIA/PORTS/VIDEO/I1/SETTINGS:dpLinkTrain()
- ◀ mO /MEDIA/PORTS/VIDEO/I1/SETTINGS:dpLinkTrain=

9.7. Audio Input Port Settings

The current setting can be queried by using the [GET command](#) in all cases.

DIFFERENCE: Audio settings are available when there is an analog audio port beside the chosen video port. **-A** or **-Audio** suffix in the model name refers to the analog audio feature (see the [Model Comparison table](#) about the analog audio availability).

9.7.1. Audio Mode Setting

Command and Response *#audio #analogaudio #volume #balance #gain #mute #unmute*

- ▶ SET /MEDIA/PORTS/VIDEO/<in>/ANALOGAUDIO.AudioMode=<audio_mode>
- ◀ pw /MEDIA/PORTS/VIDEO/<in>/ANALOGAUDIO.AudioMode=<audio_mode>

Parameters

Identifier	Parameter description	Parameter values
<audio_mode>	The current audio mode	OFF: no audio in the video stream. HDMI: the original audio is embedded in the video stream ANALOG: the analog audio of the input port is embedded in the video stream.

Example

- ▶ SET /MEDIA/PORTS/VIDEO/I1/ANALOGAUDIO.AudioMode=ANALOG
- ◀ pw /MEDIA/PORTS/VIDEO/I1/ANALOGAUDIO.AudioMode=ANALOG

INFO: In case of **-Audio** suffixed models, modifying the /MEDIA/PORTS/VIDEO/<in>/ANALOGAUDIO.AudioMode=<audio_mode> property will change the /MEDIA/PORTS/VIDEO/<in>/EMBEDDEDAUDIO.AudioMode=<audio_mode> property.

9.7.2. Analog Audio Input Level Settings

9.7.2.1. Setting the Balance (the Exact Value)

Command and Response

- ▶ SET /MEDIA/PORTS/VIDEO/<in>/ANALOGAUDIO.Balance=<bal_value>
- ◀ pw /MEDIA/PORTS/VIDEO/<in>/ANALOGAUDIO.Balance=<bal_value>

Parameters

The <bal_value> can be set between -100 and 100 (0=center, +100=right, -100=left).

Example

- ▶ SET /MEDIA/PORTS/VIDEO/I1/ANALOGAUDIO.Balance=50
- ◀ pw /MEDIA/PORTS/VIDEO/I1/ANALOGAUDIO.Balance=50

9.7.2.2. Setting the Balance (by a Step Value)

Command and Response *#audio #analogaudio #volume #balance #gain #mute #unmute*

- ▶ CALL·/MEDIA/PORTS/VIDEO/<in>/ANALOGAUDIO:stepBalance(<step_value>)
- ◀ mO·/MEDIA/PORTS/VIDEO/<in>/ANALOGAUDIO:stepBalance=<step_value>

Example

- ▶ CALL /MEDIA/PORTS/VIDEO/I1/ANALOGAUDIO:stepBalance(10)
- ◀ mO /MEDIA/PORTS/VIDEO/I1/ANALOGAUDIO:stepBalance=10

Explanation

The balance of the audio signal has been increased (right channel became higher). Positive and negative values are accepted.

9.7.2.3. Setting the Mute State

Command and Response

- ▶ SET·/MEDIA/PORTS/VIDEO/<in>/ANALOGAUDIO.Mute=<mute_state>
- ◀ pw·/MEDIA/PORTS/VIDEO/<in>/ANALOGAUDIO.Mute=<mute_state>

Parameters

If the <mute_state> parameter is **0** (or **false**), the port is not muted. If the value is **1** (or **true**), the port is muted.

Example

- ▶ SET /MEDIA/PORTS/VIDEO/I1/ANALOGAUDIO.Mute=true
- ◀ pw /MEDIA/PORTS/VIDEO/I1/ANALOGAUDIO.Mute=true

9.7.2.4. Setting the Gain

Command and Response

- ▶ SET·/MEDIA/PORTS/VIDEO/<in>/ANALOGAUDIO.Gain=<gain_value>
- ◀ pw·/MEDIA/PORTS/VIDEO/<in>/ANALOGAUDIO.Gain=<gain_value>

Parameters

Values between -12dB and +35dB are accepted and rounded automatically.

Example

- ▶ SET /MEDIA/PORTS/VIDEO/I1/ANALOGAUDIO.Gain=5
- ◀ pw /MEDIA/PORTS/VIDEO/I1/ANALOGAUDIO.Gain=5

9.8. Video Output Port Settings (HDMI and Displayport)

9.8.1. Querying the Status of the Output Ports

Command and Response

- ▶ GET·/MEDIA/XP/VIDEO.DestinationPortStatus
- ◀ pr·/MEDIA/XP/VIDEO.DestinationPortStatus=<out1_state>;<out2_state>;...; <out8_state>

The <out#_state> parameters mean the O1-O8 output ports one after the other. The value of the parameter is one letter and a 1-byte long HEX code showing the current state of the output port.

Example

- ▶ GET /MEDIA/XP/VIDEO.DestinationPortStatus
- ◀ pr /MEDIA/XP/VIDEO.DestinationPortStatus=MEF;TAA;TAA;TAA;TAA;TAA;TAA

Parameters

See the [Video Input Port Settings \(HDMI and DisplayPort\)](#) section.

Explanation

Cable is connected to Input 1, signal is present and not HDCP-encrypted, audio is embedded in the video. The port is unlocked, but muted.

9.8.2. Muting an Output

Command and Response *#mute*

- ▶ CALL·/MEDIA/XP/VIDEO:muteDestination(<out>)
- ◀ mO·/MEDIA/XP/VIDEO:muteDestination=OK

Example

- ▶ CALL /MEDIA/XP/VIDEO:muteDestination(O1;O3)
- ◀ mO /MEDIA/XP/VIDEO:muteDestination=OK

9.8.3. Unmuting an Output

Command and Response *#unmute*

- ▶ CALL·/MEDIA/XP/VIDEO:unmuteDestination(<out>)
- ◀ mO·/MEDIA/XP/VIDEO:unmuteDestination=OK

Example

- ▶ CALL /MEDIA/XP/VIDEO:unmuteDestination(O1;O2)
- ◀ mO /MEDIA/XP/VIDEO:unmuteDestination=OK

9.8.4. Locking an Output

Command and Response *#lock*

- ▶ CALL /MEDIA/XP/VIDEO:lockDestination(<out>)
- ◀ mO /MEDIA/XP/VIDEO:lockDestination=OK

Example

- ▶ CALL /MEDIA/XP/VIDEO:lockDestination(O1;O4)
- ◀ mO /MEDIA/XP/VIDEO:lockDestination=OK

9.8.5. Unlocking an Output

Command and Response *#unlock*

- ▶ CALL /MEDIA/XP/VIDEO:unlockDestination(<out>)
- ◀ mO /MEDIA/XP/VIDEO:unlockDestination=OK

Example

- ▶ CALL /MEDIA/XP/VIDEO:unlockDestination(O1;O2;O4)
- ◀ mO /MEDIA/XP/VIDEO:unlockDestination=OK

9.8.6. Setting the HDCP Mode (Output Port)

Command and Response *#hdc*

- ▶ SET /MEDIA/PORTS/VIDEO/<out>/SETTINGS.HdcpMode=<HDCP_mode>
- ◀ pw /MEDIA/PORTS/VIDEO/<out>/SETTINGS.HdcpMode=<HDCP_mode>

Parameters

Identifier	Parameter description	Parameter values
<HDCP_mode>	The HDCP mode at the output port	AUTO: the setting is the same as on the input port. The encryption of the signal on the output is the same as on the input. ALWAYS: the outgoing signal is always encrypted on the output.

Example

- ▶ SET /MEDIA/PORTS/VIDEO/O1/SETTINGS.HdcpMode=AUTO
- ◀ pw /MEDIA/PORTS/VIDEO/O1/SETTINGS.HdcpMode=AUTO

9.8.7. Setting the Audio Mode

Command and Response *#audio #analogaudio*

- ▶ SET /MEDIA/PORTS/VIDEO/<out>/EMBEDEDAUDIO.AudioMode=<audio_mode>
- ◀ pw /MEDIA/PORTS/VIDEO/<out>/EMBEDEDAUDIO.AudioMode=<audio_mode>

Parameters

Identifier	Parameter description	Parameter values
<audio_mode>	The current audio mode	OFF: no audio in the video stream HDMI: the original audio is embedded in the video stream ANALOG *: the analog audio of the input port is embedded in the video stream *Analog audio properties appear only in -Audio suffixed models, where there is an analog audio port beside the HDMI port.

Example

- ▶ SET /MEDIA/PORTS/VIDEO/O1/EMBEDEDAUDIO.AudioMode=OFF
- ◀ pw /MEDIA/PORTS/VIDEO/O1/EMBEDEDAUDIO.AudioMode=OFF

INFO: In case of **-Audio** suffixed models, modifying the /MEDIA/PORTS/VIDEO/<out>/EMBEDEDAUDIO.AudioMode=<audio_mode> property will change the /MEDIA/PORTS/VIDEO/<out>/ANALOGAUDIO.AudioMode=<audio_mode> property.

9.9. HDMI Output Settings

DIFFERENCE: HDMI settings are available in certain models, -H letter in the model name refers to that (see the [Model Comparison](#) table).

9.9.1. Setting the Signal Type (HDMI mode)

Command and Response

- ▶ SET-/MEDIA/PORTS/VIDEO/<out>/SETTINGS.ForcedSignalType=<sig_type>
- ◀ pw-/MEDIA/PORTS/VIDEO/<out>/SETTINGS.ForcedSignalType=<sig_type>

Parameters

Identifier	Parameter description	Parameter values
<sig_type>	The video signal type	DVI: the outgoing signal format is forced to be DVI . HDMI: the outgoing signal format is forced to be HDMI . AUTO: the outgoing signal format is set automatically according to the audio presence in the video stream: if audio is present, the signal format is HDMI.

Example

- ▶ SET /MEDIA/PORTS/VIDEO/01/SETTINGS.ForcedSignalType=HDMI
- ◀ pw /MEDIA/PORTS/VIDEO/01/SETTINGS.ForcedSignalType=HDMI

9.9.2. Scrambling

HDMI 2.0 standard introduced scrambling to the TMDS encoding, which helps to decrease the energy peaks, and hence the Electro Magnetic Interference (EMI). To maintain backward compatibility, HDMI 2.0 only requires the use of scrambling with data rates of above 3.4 Gbps per lane.

Command and Response *#scrambling*

- ▶ SET-/MEDIA/PORTS/VIDEO/<out>/SETTINGS.ForcedScrambling=<scr_mode>
- ◀ pw-/MEDIA/PORTS/VIDEO/<out>/SETTINGS.ForcedScrambling=<scr_mode>

Parameters

The option can be set on the output ports to **AUTO / ON / OFF**.

Example

- ▶ SET /MEDIA/PORTS/VIDEO/01/SETTINGS.ForcedScrambling=AUTO
- ◀ pw /MEDIA/PORTS/VIDEO/01/SETTINGS.ForcedScrambling=AUTO

9.9.3. Setting the Signal Conversion Mode

ATTENTION! The signal conversion can be set on the input and output ports as well, but setting the desired signal at the output port is recommended. The signal conversion on the input side is mainly for testing purposes.

Conversion *#colorspace*

The outgoing signal can be routed to the outputs with or without conversion as follows:

Command and Response *#colorspace*

- ▶ SET-/MEDIA/PORTS/VIDEO/<out>/SETTINGS.Conversion=<conv_mode>
- ◀ pw-/MEDIA/PORTS/VIDEO/<out>/SETTINGS.Conversion=<conv_mode>

Parameters

Identifier	Parameter description	Parameter values
<conv_mode>	The video conversion mode	OFF: there is no signal conversion. 420*: the signal is converted to the indicated color depth. 422**: The signal is converted to the indicated color depth. The matrix switcher accepts video signals in 8, 10 and 12 bit color depth, but the sampling pattern conversion is always made in 8 bit. LEFT and RIGHT*: The device supports vertical splitting of an HDMI 2.0 4K@60Hz 4:4:4 input signal to left and right halves, allowing the transmission of an 18Gbps HDMI2.0 signal over two HDMI1.4 compliant links. The two halves can then be recombined at the signal destination. To apply the feature, route the same input signal to 2 output ports. Set the conversion to LEFT on one output port and RIGHT on the other output port.

*The availability of this property depends on the hardware version of the output board (V1x_) of the HDMI port. The hardware version can be found in the [Status Tab](#) in the LDC or in the [System Settings Menu, Device Info](#) submenu in the LCD.

** The availability of **4:4:4 to 4:2:2 conversion** depends on the hardware version of the output board (V2x_). The hardware version can be checked in the [Status Tab](#) in the LDC or in the [System Settings Menu, Device Info](#) submenu in the LCD.

Example

- ▶ SET /MEDIA/PORTS/VIDEO/01/SETTINGS.Conversion=OFF
- ◀ pw /MEDIA/PORTS/VIDEO/01/SETTINGS.Conversion=OFF

9.9.4. Sending CEC Commands Towards the Sink

INFO: The hidden first 2x2 bits of the CEC command are static (always 40), they refer to the logical address of the sender and the addressee. 4: sender is a **Playback Device 1**. ; 4: the addressee is the **TV**. #cec

INFO: According to the standard, the CEC feature works only at HDMI ports.

9.9.4.1. Sending an OSD String

Sending the OSD string consists of two steps. First, set the `CEC.OsdString` property with the desired text, after that call the `CEC.send(set_osd)` method.

Step 1 – Setting the CEC.OsdString Property

Command and Response

- ▶ SET /MEDIA/PORTS/<out>/CEC.OsdString=<text>
- ◀ pw /MEDIA/PORTS/<out>/CEC.OsdString=<text>

Parameters

The following characters are allowed in the text: Letters (A-Z) and (a-z), hyphen (-), underscore (_), numbers (0-9), and dot (.). Max length: 14 characters.

Example

- ▶ SET /MEDIA/PORTS/VIDEO/01/CEC.OsdString=Lightware
- ◀ pw /MEDIA/PORTS/VIDEO/01/CEC.OsdString=Lightware

Step 2 – Calling the CEC.send(set_osd) Method

Command and Response

- ▶ CALL /MEDIA/PORTS/VIDEO/<out>/CEC:send(set_osd)
- ◀ m0 /MEDIA/PORTS/VIDEO/<out>/CEC:send=OK

Example

- ▶ CALL /MEDIA/PORTS/VIDEO/01/CEC:send(set_osd)
- ◀ m0 /MEDIA/PORTS/VIDEO/01/CEC:send=OK

9.9.4.2. Sending a CEC Command in Text Format

INFO: According to the standard, the CEC feature works only at HDMI ports.

Command and Response

#cec

- ▶ CALL /MEDIA/PORTS/VIDEO/<out>/CEC:send(<command>)
- ◀ m0 /MEDIA/PORTS/VIDEO/<out>/CEC:send=OK

Example

- ▶ CALL /MEDIA/PORTS/VIDEO/01/CEC:send(power_on)
- ◀ m0 /MEDIA/PORTS/VIDEO/01/CEC:send=OK

The following are accepted as a <command>:

image_view_on	standby	ok	back	up
down	left	right	root_menu	setup_menu
contents_menu	favorite_menu	media_top_menu	media_context_menu	number_0
number_1	number_2	number_3	number_4	number_5
number_6	number_7	number_8	number_9	dot
enter	clear	channel_up	channel_down	sound_select
input_select	display_info	power_legacy	page_up	page_down
volume_up	volume_down	mute_toggle	mute	unmute
play	stop	pause	record	rewind
fast_forward	eject	skip_forward	skip_backward	3d_mode
stop_record	pause_record	play_forward	play_reverse	select_next_media
select_media_1	select_media_2	select_media_3	select_media_4	select_media_5
power_toggle	power_on	power_off	stop_function	f1
f2	f3	f4		

9.9.4.3. Sending a CEC Command in Hexadecimal Format

INFO: According to the standard, the CEC feature works only at HDMI ports.

Command and Response

- ▶ CALL /MEDIA/PORTS/VIDEO/<out>/CEC:sendHex(<hex_command>)
- ◀ m0 /MEDIA/PORTS/VIDEO/<out>/CEC:sendHex=OK

Parameters

Accepted <hex_command> value can be max. 30 characters long (15 bytes) in hexadecimal format. The codes are separated with a space character.

Example

- ▶ CALL /MEDIA/PORTS/VIDEO/01/CEC:sendHex(87 00 E0 91)
- ◀ m0 /MEDIA/PORTS/VIDEO/01/CEC:sendHex=OK

9.10. DisplayPort Output Settings

The current setting can be queried by using the [GET command](#).

DIFFERENCE: DisplayPort settings are available in certain models, -D letter in the model name refers to that (see the [Model Comparison](#) table).

9.10.1. Enabling DP Power

This property allows providing 1.5W (500mA @ 3.3W) power on DP_PWR pin. The default value is true.

Command and Response *#dppower*

- ▶ SET·/MEDIA/PORTS/VIDEO/<out>/SETTINGS.EnablePower=<enable_power>
- ◀ pw·/MEDIA/PORTS/VIDEO/<out>/SETTINGS.EnablePower=<enable_power>

Parameters

Identifier	Parameter description	Parameter values
<enable_power>	The matrix can provide 1.5W power on each Displayport connector.	true: The matrix sends 1.5W power on the chosen port. false: The matrix does not provide any power on the chosen port.

Example

- ▶ SET /MEDIA/PORTS/VIDEO/O1/SETTINGS.EnablePower=true
- ◀ pw /MEDIA/PORTS/VIDEO/O1/SETTINGS.EnablePower=true

9.10.2. Enabling Forced Link Training

Command and Response *#linktraining*

- ▶ SET·/MEDIA/PORTS/VIDEO/<out>/SETTINGS.DpForcedMode=<forced_mode>
- ◀ pw·/MEDIA/PORTS/VIDEO/<out>/SETTINGS.DpForcedMode=<forced_mode>

Parameters

Identifier	Parameter description	Parameter values
<forced_mode>	It allows the configuration of the output link training parameters (Link datarate, Link lane, Swing / pre-emphasis) manually, the link training process is skipped.	true: The link training mode is Forced . Link datarate, Link lane count and Swing / pre-emphasis parameters can be modified. false: The link training mode is Automatic . The matrix and the agree on the link training parameters automatically without any user interruption.

Example

- ▶ SET /MEDIA/PORTS/VIDEO/O1/SETTINGS.DpForcedMode=true
- ◀ pw /MEDIA/PORTS/VIDEO/O1/SETTINGS.DpForcedMode=true

9.10.3. Setting the Forced Lane Number

Command and Response

- ▶ SET·/MEDIA/PORTS/VIDEO/<out>/SETTINGS.DpForcedLaneCount=<lane>
- ◀ pw·/MEDIA/PORTS/VIDEO/<out>/SETTINGS.DpForcedLaneCount=<lane>

Parameters

Identifier	Parameter description	Parameter values
<lane>	DisplayPort data transmission proceeds through the lanes. This defines the number of lanes used.	1: One lane is able to transmit 5.4 Gbps of data. 2: Two lanes are able to transmit 10.8 Gbps of data. 4: Four lanes are able to transmit 21.6 Gbps of data.

Example

- ▶ SET /MEDIA/PORTS/VIDEO/O1/SETTINGS.DpForcedLaneCount=2
- ◀ pw /MEDIA/PORTS/VIDEO/O1/SETTINGS.DpForcedLaneCount=2

For more details about the Forced link training, see the [General Tab - Displayport Link](#) section.

9.10.4. Setting the Forced Link Data Rate

Command and Response

- ▶ SET·/MEDIA/PORTS/VIDEO/<out>/SETTINGS.DpForcedLinkRate=<data_rate>
- ◀ pw·/MEDIA/PORTS/VIDEO/<out>/SETTINGS.DpForcedLinkRate=<data_rate>

Parameters

Identifier	Parameter description	Parameter values
<data_rate>	The data rate per lane.	RBR: Reduced Bit Rate uses 1.62 Gbps bandwidth. HBR: High Bit Rate uses 2.70 Gbps bandwidth. HBR2: High Bit Rate2 uses 5.40 Gbps bandwidth.

Example

- ▶ SET /MEDIA/PORTS/VIDEO/O1/SETTINGS.DpForcedLinkRate=HBR2
- ◀ pw /MEDIA/PORTS/VIDEO/O1/SETTINGS.DpMaxLinkRate=HBR2

For more details about the Forced link training, see the [General Tab - Displayport Link](#) section.

9.10.5. Setting the Swing / pre-emphasis

Command and Response

- ▶ SET /MEDIA/PORTS/VIDEO/<out>/SETTINGS.DpForcedLaneLevel=<voltage_level>;<preemph_level>;
- ◀ pw /MEDIA/PORTS/VIDEO/<out>/SETTINGS.DpForcedLaneLevel=<voltage_level>;<preemph_level>;

Parameters

Identifier	Parameter description	Parameter values
<voltage_level>	Forced voltage level on main link lanes. Valid for all lanes.	0: 400mV 1: 600mV 2: 800mV
<preemph_level>	Forced preemphasis level on main link lanes. Valid for all lanes.	0: 0 dB 1: 3.5 dB 2: 6 dB

Example

- ▶ SET /MEDIA/PORTS/VIDEO/08/SETTINGS.DpForcedLaneLevel=0;2;
- ◀ pw /MEDIA/PORTS/VIDEO/08/SETTINGS.DpForcedLaneLevel=0;2;

For more details about the Forced link training see [General Tab - Displayport Link](#) section.

9.10.6. Restarting Link Training

This method is equal to pulling the DP connector out and plugging it in again.

Command and Response

- ▶ CALL /MEDIA/PORTS/VIDEO/<out>/SETTINGS:dpLinkTrain()
- ◀ m0 /MEDIA/PORTS/VIDEO/<out>/SETTINGS:dpLinkTrain=

Example

- ▶ CALL /MEDIA/PORTS/VIDEO/01/SETTINGS:dpLinkTrain()
- ◀ m0 /MEDIA/PORTS/VIDEO/01/SETTINGS:dpLinkTrain=

9.11. Audio Output Port Settings

INFO: The current setting can be queried by using the [GET command](#) in all cases.

9.11.1. Audio Mode Setting

DIFFERENCE: Analog audio properties appear only in **-A or -Audio** suffixed models, where there is an analog audio port beside the HDMI port. *#audio #analogaudio #volume #balance #mute #unmute*

Command and Response

- ▶ SET /MEDIA/PORTS/VIDEO/<out>/ANALOGAUDIO.AudioMode=<audio_mode>
- ◀ pw /MEDIA/PORTS/VIDEO/<out>/ANALOGAUDIO.AudioMode=<audio_mode>

Parameters

Identifier	Parameter description	Parameter values
<audio_mode>	The audio working mode	OFF: Audio is not present in the HDMI stream nor on the Analog Audio output port. HDMI: Audio is present only in the HDMI stream. ANALOG: Audio is present only on the Analog Audio output port. HDMI+ANALOG: Audio is present in the HDMI stream and on the Analog Audio output port.

Example

- ▶ SET /MEDIA/PORTS/VIDEO/01/ANALOGAUDIO.AudioMode=HDMI
- ◀ pw /MEDIA/PORTS/VIDEO/01/ANALOGAUDIO.AudioMode=HDMI

9.11.2. Analog Audio Output Level Settings

DIFFERENCE: Analog audio properties appear only in **-A** or **-Audio** suffixed models, where there is an analog audio port beside the HDMI port.

9.11.2.1. Setting the Volume (Exact Value)

Command and Response

- ▶ SET /MEDIA/PORTS/VIDEO/<out>/ANALOGAUDIO.VolunedB=<vol_value>
- ◀ pw /MEDIA/PORTS/VIDEO/<out>/ANALOGAUDIO.VolunedB=<vol_value>

Parameters

The <vol_value> parameter can be set between -95.62 dB and 0 dB.

Example

- ▶ SET /MEDIA/PORTS/VIDEO/O1/ANALOGAUDIO.VolunedB=-10
- ◀ pw /MEDIA/PORTS/VIDEO/O1/ANALOGAUDIO.VolunedB=-10.00

9.11.2.2. Setting the Volume (by Step Value)

Command and Response

- ▶ CALL /MEDIA/PORTS/VIDEO/<out>/ANALOGAUDIO:stepVolunedB(<step_value>)
- ◀ mO /MEDIA/PORTS/VIDEO/<out>/ANALOGAUDIO:stepVolunedB=<step_value>

Example

- ▶ CALL /MEDIA/PORTS/VIDEO/O1/ANALOGAUDIO:stepVolunedB(-2)
- ◀ mO /MEDIA/PORTS/VIDEO/O1/ANALOGAUDIO:stepVolunedB=-2

The volume of the audio signal is decreased by 2 dB. Positive and negative values are accepted.

INFO: The Volume can also be set by the following method and property: **VolumePercent**, **StepVolumePercent**.

9.11.2.3. Setting the Balance (Exact Value)

Command and Response

- ▶ SET /MEDIA/PORTS/VIDEO/<out>/ANALOGAUDIO.Balance=<bal_value>
- ◀ pw /MEDIA/PORTS/VIDEO/<out>/ANALOGAUDIO.Balance=<bal_value>

Parameters

The <bal_value> parameter can be set between -100 and +100 (0=center, +100=right, -100=left).

Example

- ▶ SET /MEDIA/PORTS/VIDEO/O1/ANALOGAUDIO.Balance=10
- ◀ pw /MEDIA/PORTS/VIDEO/O1/ANALOGAUDIO.Balance=10

9.11.2.4. Setting the Balance (by Step Value)

Command and Response

- ▶ CALL /MEDIA/PORTS/VIDEO/<out>/ANALOGAUDIO:stepBalance(<step_value>)
- ◀ mO /MEDIA/PORTS/VIDEO/<out>/ANALOGAUDIO:stepBalance=<step_value>

Example

- ▶ CALL /MEDIA/PORTS/VIDEO/O1/ANALOGAUDIO:stepBalance(-10)
- ◀ mO /MEDIA/PORTS/VIDEO/O1/ANALOGAUDIO:stepBalance=-10

The balance of the audio signal is decreased (left channel became louder). Positive and negative values are accepted.

9.11.2.5. Setting the Mute State

Command and Response

- ▶ SET /MEDIA/PORTS/VIDEO/<out>/ANALOGAUDIO.Mute=<mute_state>
- ◀ pw /MEDIA/PORTS/VIDEO/<out>/ANALOGAUDIO.Mute=<mute_state>

Parameters

If the <mute_state> parameter is **0** (or **false**), the port is not muted. If the value is **1** (or **true**), the port is muted.

Example

- ▶ SET /MEDIA/PORTS/VIDEO/O1/ANALOGAUDIO.Mute=true
- ◀ pw /MEDIA/PORTS/VIDEO/O1/ANALOGAUDIO.Mute=true

9.12. Preset Handling

The router can store presets, and the following are stored in each slot: input/output crosspoint state, muted/unmuted states. Preset loading has an effect on all ports, except the locked ones.

9.12.1. Creating a New Preset

Command and Response *#preset*

- ▶ CALL /MEDIA/PRESET:create(<preset_name>,VIDEO)
- ◀ mO /MEDIA/PRESET:create=

Parameters

Up to 16 characters are allowed as <preset_name>. Letters (A-Z and a-z), hyphen (-), underscore (_), and numbers (0-9) are accepted. 'VIDEO' is a mandatory parameter.

Example

- ▶ CALL /MEDIA/PRESET:create(My_pres,VIDEO)
- ◀ mO /MEDIA/PRESET:create=

Explanation

The preset is stored as a new node (My_pres) under the /MEDIA/PRESET/ node.

9.12.2. Saving the Settings to an Existing Preset

Command and Response

- ▶ CALL /MEDIA/PRESET/<preset_name>:save(1)
- ◀ mO /MEDIA/PRESET/<preset_name>:save=Ok

Example

- ▶ CALL /MEDIA/PRESET/My_pres:save(My_pres)
- ◀ mO /MEDIA/PRESET/My_pres:save=Ok

The existing 'My_pres' has been overwritten with the current settings.

9.12.3. Loading a Preset

Command and Response

- ▶ CALL /MEDIA/PRESET/<preset_name>:load()
- ◀ mO /MEDIA/PRESET/<preset_name>:load=Ok

Example

- ▶ CALL /MEDIA/PRESET/My_pres:load()
- ◀ mO /MEDIA/PRESET/My_pres:load=Ok

Explanation

'My_pres' preset has been loaded and applied.

9.12.4. Renaming a Preset

Command and Response

- ▶ CALL /MEDIA/PRESET:rename(<Old_name>,<New_name>)
- ◀ mO /MEDIA/PRESET:rename=

Example

- ▶ CALL /MEDIA/PRESET:rename(My_Pres,Your_Pres)
- ◀ mO /MEDIA/PRESET:rename=

Explanation

The preset has been renamed to 'Your_Pres'.

9.13. Network Settings

ATTENTION! When any parameter of the network settings is modified, always apply the new settings by calling the following method: `CALL /MANAGEMENT/NETWORK:applySettings() #network #ipaddress #dhcp`

9.13.1. Querying the Current IP Address

Command and Response

- ▶ GET /MANAGEMENT/NETWORK.IpAddress
- ◀ pr /MANAGEMENT/NETWORK.IpAddress=<IP_address>

Example

- ▶ GET /MANAGEMENT/NETWORK.IpAddress
- ◀ pr /MANAGEMENT/NETWORK.IpAddress=192.168.0.101
- ▶ CALL /MANAGEMENT/NETWORK:applySettings()
- ◀ m0 /MANAGEMENT/NETWORK:applySettings=

9.13.2. Setting a Dynamic IP Address

Command and Response

- ▶ SET /MANAGEMENT/NETWORK.DhcpEnabled=<DHCP_state>
- ◀ pw /MANAGEMENT/NETWORK.DhcpEnabled=<DHCP_state>

Parameters

If the <DHCP_state> parameter is **0** (or **false**), the device is set to apply a static IP address. If the value is **1** (or **true**), the device is set to get a dynamic IP address from the DHCP server in the network.

Example

- ▶ SET /MANAGEMENT/NETWORK.DhcpEnabled=true
- ◀ pw /MANAGEMENT/NETWORK.DhcpEnabled=true
- ▶ CALL /MANAGEMENT/NETWORK:applySettings()
- ◀ m0 /MANAGEMENT/NETWORK:applySettings=

9.13.3. Static IP Address Settings

ATTENTION! To set a static IP address, set the `DhcpEnabled` property to **false** – see the previous section.

9.13.3.1. Setting an IP address

Command and Response

- ▶ SET /MANAGEMENT/NETWORK.StaticIpAddress=<IP_address>
- ◀ pw /MANAGEMENT/NETWORK.StaticIpAddress=<IP_address>

Example

- ▶ SET /MANAGEMENT/NETWORK.StaticIpAddress=192.168.0.80
- ◀ pw /MANAGEMENT/NETWORK.StaticIpAddress=192.168.0.80
- ▶ CALL /MANAGEMENT/NETWORK:applySettings()
- ◀ m0 /MANAGEMENT/NETWORK:applySettings=

9.13.3.2. Subnet Mask Setting

Command and Response

- ▶ SET /MANAGEMENT/NETWORK.StaticNetworkMask=<Net_mask>
- ◀ pw /MANAGEMENT/NETWORK.StaticNetworkMask=<Net_mask>

Example

- ▶ SET /MANAGEMENT/NETWORK.StaticNetworkMask=255.255.0.0
- ◀ pw /MANAGEMENT/NETWORK.StaticNetworkMask=255.255.0.0
- ▶ CALL /MANAGEMENT/NETWORK:applySettings()
- ◀ m0 /MANAGEMENT/NETWORK:applySettings=

9.13.3.3. Gateway Setting

Command and Response

- ▶ SET /MANAGEMENT/NETWORK.StaticGatewayAddress=<Gateway_address>
- ◀ pw /MANAGEMENT/NETWORK.StaticGatewayAddress=<Gateway_address>

Example

- ▶ SET /MANAGEMENT/NETWORK.StaticGatewayAddress=192.168.0.1
- ◀ pw /MANAGEMENT/NETWORK.StaticGatewayAddress=192.168.0.1
- ▶ CALL /MANAGEMENT/NETWORK:applySettings()
- ◀ m0 /MANAGEMENT/NETWORK:applySettings=

9.14. EDID Management

9.14.1. Querying the Emulated EDIDs

Command and Response *#edid*

- ▶ GET /EDID.EdidStatus
- ◀ pr /EDID.EdidStatus=<E1_EDID>;<E2_EDID>;...;<E8_EDID>

Parameters

The <E#_EDID> parameters mean the I1-I8 (E1-E8) input ports one after the other. The value of the parameter shows the location of the currently emulated EDID at the given input port.

Example

- ▶ GET /EDID.EdidStatus
- ◀ pr /EDID.EdidStatus=U1;U1;D2;D2;F49;F49;F49;F49

Explanation

The U1 (User) EDID is emulated on Input1 and Input 2. D2 (Dynamic) EDID is emulated on Input3 and Input4, and F49 (Factory) EDID is emulated on the other input ports.

9.14.2. Setting the Emulated EDID

Command and Response

- ▶ CALL /EDID:switch(<Source>:<Destination>)
- ◀ mO /EDID:switch=

Parameters

Identifier	Parameter description	Parameter values
<source>	Source EDID memory place	F1-F148: Factory presets. D1-D8: Dynamic EDID from the sink connected to the output port. U1-U100: User EDID memory.
<destination>	Emulated EDID memory place	E1-E8: The emulated EDID memory location of the input port.

Example

- ▶ CALL /EDID:switch(F49:E1;F29:E5)
- ◀ mO /EDID:switch=

9.14.3. Copying an EDID into the User EDID Memory

ATTENTION! The (User) EDID memory slot will be overwritten without notification even if it was not empty.

Command and Response

- ▶ CALL /EDID:copy(<source>:<destination>)
- ◀ mO /EDID:copy=

Parameters

Identifier	Parameter description	Parameter values
<source>	Source EDID memory place	F1-F148: Factory presets. D1-D8: Dynamic EDID from the sink connected to the output port. U1-U100: User EDID memory.
<destination>	User EDID memory	U1-U100: The destination User EDID memory slot.

Example

- ▶ CALL /EDID:copy(D2:U5;D3:U6)
- ◀ mO /EDID:copy=

9.15. RS-232 Port Settings

INFO: The current setting can be queried by using the [GET command](#).

9.15.1. Setting the Current Command Protocol

Command and Response *#serial #rs232 #rs-232*

- ▶ SET /MANAGEMENT/SERIAL.Protocol=<prot_mode>
- ◀ pw /MANAGEMENT/SERIAL.Protocol=<prot_mode>

Parameters

Identifier	Parameter description	Parameter values
<prot_mode>	The applied protocol of the RS-232 port	LW2: Lightware Protocol #2 is applied. LW3: Lightware Protocol #3 is applied. P#2: The additional P#2 protocol is applied.

Example

- ▶ SET /MANAGEMENT/SERIAL.Protocol=LW3
- ◀ pw /MANAGEMENT/SERIAL.Protocol=LW3

9.15.2. Setting the Baud Rate

Command and Response

- ▶ SET /MANAGEMENT/SERIAL.Baudrate=<BAUD_value>
- ◀ pw /MANAGEMENT/SERIAL.Baudrate=<BAUD_value>

Parameters

The following values are accepted: 200, 300, 600, 1200, 1800, 2400, 4800, 9600, 19200, 38400, 57600, 115200.

Example

- ▶ SET /MANAGEMENT/SERIAL.Baudrate=57600
- ◀ pw /MANAGEMENT/SERIAL.Baudrate=57600

9.16. LW3 Commands – Quick Summary

System Commands

Querying the Product Name

- ▶ GET·/.ProductName

Setting the Device Label

- ▶ SET·/MANAGEMENT/UID/DeviceLabel=<Custom_name>

Querying the Serial Number

- ▶ GET·/.SerialNumber

Resetting the Matrix

- ▶ CALL·/SYS:softReset()

Restoring the Factory Default Settings

- ▶ CALL·/SYS:factoryDefaults()

Querying the Operation Mode (Standby Mode) of the Matrix

- ▶ GET·/MANAGEMENT/POWER.Operation

Switching to Standby Mode

- ▶ CALL·/MANAGEMENT/POWER:standby()

Switching to Normal Mode

- ▶ CALL·/MANAGEMENT/POWER:wakeUp()

Switching and Crosspoint Settings

Querying the Video Crosspoint State

- ▶ GET·/MEDIA/XP/VIDEO.DestinationConnectionStatus

Switching an Input to an Output

- ▶ CALL·/MEDIA/XP/VIDEO:switch(<in>:<out>)

Disconnecting the Output from any Input

- ▶ CALL·/MEDIA/XP/VIDEO:switch(0:<out>)

Switching an Input to All Outputs

- ▶ CALL·/MEDIA/XP/VIDEO:switchAll(<in>)

Multiple Switching

- ▶ CALL·/MEDIA/XP/VIDEO:switchMulti(<out1_source>;<out2_source>;...;<out8_source>)

Setting the HDCP State

- ▶ SET·/MEDIA/PORTS/VIDEO/<in>/SETTINGS.HdcpVersion=<HDCP_ver>

Muting an Input Port

- ▶ CALL·/MEDIA/XPVIDEO:muteSource(<in>)

Unmuting an Input Port

- ▶ CALL·/MEDIA/XP/VIDEO:unmuteSource(<in>)

Locking an Input Port

- ▶ CALL·/MEDIA/XP/VIDEO:lockSource(<in>)

Unlocking an Input Port

- ▶ CALL·/MEDIA/XP/VIDEO:unlockSource(<in>)

Querying the Status of the Source Ports

- ▶ GET·/MEDIA/XP/VIDEO.SourcePortStatus

Setting the Audio Mode

- ▶ SET·/MEDIA/PORTS/VIDEO/<in>/EMBEDDEDAUDIO.AudioMode=<audio_mode>

Sending CEC Commands Towards the Source

- ▶ SET·/MEDIA/PORTS/<in>/CEC.OsdString=<text>
- ▶ CALL·/MEDIA/PORTS/VIDEO/<in>/CEC:send(set_osd)

Sending a CEC Command in Text Format

- ▶ CALL·/MEDIA/PORTS/VIDEO/<in>/CEC:send(<command>)

Sending a CEC Command in Hexadecimal Format

- ▶ CALL·/MEDIA/PORTS/VIDEO/<in>/CEC:sendHex(<hex_command>)

DisplayPort Input Settings

Setting the Maximum Lane Number

- ▶ SET·/MEDIA/PORTS/VIDEO/<in>/SETTINGS.DpMaxLaneCount=<lane>

Enabling DP Power

- ▶ SET·/MEDIA/PORTS/VIDEO/<out>/SETTINGS.EnablePower=<enable_power>

Setting the Maximum Link Data Rate

- ▶ SET·/MEDIA/PORTS/VIDEO/<in>/SETTINGS.DpMaxLinkRate=<data_rate>

Enabling the Test Pattern

- ▶ SET·/MEDIA/PORTS/VIDEO/<in>/SETTINGS.TpgMode=<tpg_status>

Setting the Conversion Mode

- ▶ SET·/MEDIA/PORTS/VIDEO/<in>/SETTINGS.Conversion=<conversion_mode>

Restarting Link Training

- ▶ CALL·/MEDIA/PORTS/VIDEO/<in>/SETTINGS:dpLinkTrain()

Audio Input Port Settings**Audio Mode Setting**

- ▶ SET·/MEDIA/PORTS/VIDEO/<in>/ANALOGAUDIO.AudioMode=<audio_mode>

Setting the Balance (the Exact Value)

- ▶ SET·/MEDIA/PORTS/VIDEO/<in>/ANALOGAUDIO.Balance=<bal_value>

Setting the Balance (by a Step Value)

- ▶ CALL·/MEDIA/PORTS/VIDEO/<in>/ANALOGAUDIO:stepBalance(<step_value>)

Setting the Mute State

- ▶ SET·/MEDIA/PORTS/VIDEO/<in>/ANALOGAUDIO.Mute=<mute_state>

Setting the Gain

- ▶ SET·/MEDIA/PORTS/VIDEO/<in>/ANALOGAUDIO.Gain=<gain_value>

Video Output Port Settings (HDMI and Displayport)**Querying the Status of the Output Ports**

- ▶ GET·/MEDIA/XP/VIDEO.DestinationPortStatus

Muting an Output

- ▶ CALL·/MEDIA/XP/VIDEO:muteDestination(<out>)

Unmuting an Output

- ▶ CALL·/MEDIA/XP/VIDEO:unmuteDestination(<out>)

Locking an Output

- ▶ CALL·/MEDIA/XP/VIDEO:lockDestination(<out>)

Unlocking an Output

- ▶ CALL·/MEDIA/XP/VIDEO:unlockDestination(<out>)

Setting the HDCP Mode (Output Port)

- ▶ SET·/MEDIA/PORTS/VIDEO/<out>/SETTINGS.HdcpMode=<HDCP_mode>

Setting the Audio Mode

- ▶ SET·/MEDIA/PORTS/VIDEO/<out>/EMBEDDEDAUDIO.AudioMode=<audio_mode>

HDMI Output Settings**Setting the Signal Type (HDMI mode)**

- ▶ SET·/MEDIA/PORTS/VIDEO/<out>/SETTINGS.ForcedSignalType=<sig_type>

Scrambling

- ▶ SET·/MEDIA/PORTS/VIDEO/<out>/SETTINGS.ForcedScrambling=<scr_mode>

Setting the Signal Conversion Mode

- ▶ SET·/MEDIA/PORTS/VIDEO/<out>/SETTINGS.Conversion=<conv_mode>

Sending CEC Commands Towards the Sink

- ▶ SET·/MEDIA/PORTS/<out>/CEC.OsdString=<text>
- ▶ CALL·/MEDIA/PORTS/VIDEO/<out>/CEC:send(set_osd)

Sending a CEC Command in Text Format

- ▶ CALL·/MEDIA/PORTS/VIDEO/<out>/CEC:send(<command>)

Sending a CEC Command in Hexadecimal Format

- ▶ CALL·/MEDIA/PORTS/VIDEO/<out>/CEC:sendHex(<hex_command>)

DisplayPort Output Settings**Enabling DP Power**

- ▶ SET·/MEDIA/PORTS/VIDEO/<out>/SETTINGS.EnablePower=<enable_power>

Enabling Forced Link Training

- ▶ SET·/MEDIA/PORTS/VIDEO/<out>/SETTINGS.DpForcedMode=<forced_mode>

Setting the Forced Lane Number

- ▶ SET·/MEDIA/PORTS/VIDEO/<out>/SETTINGS.DpForcedLaneCount=<lane>

Setting the Forced Link Data Rate

- ▶ SET·/MEDIA/PORTS/VIDEO/<out>/SETTINGS.DpForcedLinkRate=<data_rate>

Setting the Swing / pre-emphasis

- ▶ SET·/MEDIA/PORTS/VIDEO/<out>/SETTINGS.DpForcedLaneLevel=<voltage_level>;<preemph_level>;

Restarting Link Training

- ▶ CALL·/MEDIA/PORTS/VIDEO/<out>/SETTINGS:dpLinkTrain()

Audio Output Port Settings**Audio Mode Setting**

- ▶ SET·/MEDIA/PORTS/VIDEO/<out>/ANALOGAUDIO.AudioMode=<audio_mode>

Setting the Volume (Exact Value)

- ▶ SET·/MEDIA/PORTS/VIDEO/<out>/ANALOGAUDIO.VolumedB=<vol_value>

Setting the Volume (by Step Value)

- ▶ CALL·/MEDIA/PORTS/VIDEO/<out>/ANALOGAUDIO:stepVolumedB(<step_value>)

Setting the Balance (Exact Value)

- ▶ SET·/MEDIA/PORTS/VIDEO/<out>/ANALOGAUDIO.Balance=<bal_value>

Setting the Balance (by Step Value)

- ▶ CALL·/MEDIA/PORTS/VIDEO/<out>/ANALOGAUDIO:stepBalance(<step_value>)

Setting the Mute State

- ▶ SET·/MEDIA/PORTS/VIDEO/<out>/ANALOGAUDIO.Mute=<mute_state>

Preset Handling**Creating a New Preset**

- ▶ CALL·/MEDIA/PRESET:create(<preset_name>,VIDEO)

Saving the Settings to an Existing Preset

- ▶ CALL·/MEDIA/PRESET/<preset_name>:save(1)

Loading a Preset

- ▶ CALL·/MEDIA/PRESET/<preset_name>:load()

Renaming a Preset

- ▶ CALL·/MEDIA/PRESET:rename(<Old_name>,<New_name>)

Network Settings**Querying the Current IP Address**

- ▶ GET·/MANAGEMENT/NETWORK.IpAddress

Setting a Dynamic IP Address

- ▶ SET·/MANAGEMENT/NETWORK.DhcpEnabled=<DHCP_state>

Setting an IP address

- ▶ SET·/MANAGEMENT/NETWORK.StaticIpAddress=<IP_address>

Subnet Mask Setting

- ▶ SET·/MANAGEMENT/NETWORK.StaticNetworkMask=<Net_mask>

Gateway Setting

- ▶ SET·/MANAGEMENT/NETWORK.StaticGatewayAddress=<Gateway_address>

EDID Management**Querying the Emulated EDIDs**

- ▶ GET·/EDID.EdidStatus

Setting the Emulated EDID

- ▶ CALL·/EDID:switch(<Source>:<Destination>)

Copying an EDID into the User EDID Memory

- ▶ CALL·/EDID:copy(<source>:<destination>)

RS-232 Port Settings**Setting the Current Command Protocol**

- ▶ SET·/MANAGEMENT/SERIAL.Protocol=<prot_mode>

Setting the Baud Rate

- ▶ SET·/MANAGEMENT/SERIAL.Baudrate=<BAUD_value>

10

Firmware Update

This chapter is meant to help customers perform firmware updates on our products by giving a few tips on how to start and by explaining the features of the Lightware Device Updater v2 (LDU2) software. The latest software and firmware pack can be downloaded from www.lightware.com.

- ▶ [BACKWARD COMPATIBILITY](#)
- ▶ [INTRODUCTION](#)
- ▶ [PREPARATION](#)
- ▶ [RUNNING THE SOFTWARE](#)
- ▶ [THE UPDATING STEPS](#)
- ▶ [UPDATING VIA GUI](#)
- ▶ [COMMAND LINE INTERFACE \(CLI\)](#)
- ▶ [CLI COMMANDS](#)
- ▶ [IF THE UPDATE IS NOT SUCCESSFUL](#)

10.1. Backward Compatibility

Up to 1.2.0 firmware version, the firmware packages are in **.lfp** format (LFP1 file), the update can be done with Lightware Device Updater v1 (LDU1) software.

Above 1.2.0 firmware version, the firmware package format is **.lfp2** (LFP2 file) the update can be done with Lightware Device Updater v2 (LDU2) software.

ATTENTION! While the firmware is being updated, the normal operation mode is suspended, as the device is switched to bootload mode. The firmware update process has an effect on the configuration and the settings of the device.

10.2. Introduction

Lightware Device Updater v2 (LDU2) software is the second generation of the LFP-based (Lightware Firmware Package) firmware update process.

DIFFERENCE: This software can be used for uploading the packages with LFP2 extension only. LDU2 is not suitable for using LFP files, please use the LDU software for that firmware update.



10.3. Preparation

Most Lightware devices can be controlled over several interfaces (e.g. Ethernet, USB, RS-232). But the firmware can be updated usually over one dedicated interface, which is the Ethernet in most cases.

If you want to update the firmware of one or more devices you need the following:

- **LFP2 file,**
- **LDU2 software** installed on your PC or Mac.

Both can be downloaded from www.lightware.com/downloads.

Optionally, you can download the **release notes** file in HTML format.

10.3.1. About the Firmware Package (LFP2 File)

All necessary tools and binary files are packed into the LFP2 package file. You need only this file to do the update on your device.

- This allows the use of the same LFP2 package for different devices.
- The package contains all the necessary components, binary, and other files.
- The release notes is included in the LFP2 file, which is displayed in the window where you select the firmware package file in LDU2.

10.3.2. LDU2 Installation

ATTENTION! Minimum system requirement: 2 GB RAM. The minimum screen resolution is 1600x900.

ATTENTION! Certain ports are used for the communication in the background; please check the list in the [Applied Ports \(Network Settings\)](#) section.

INFO: The Windows, Mac and Linux applications have the same look and functionality.

Download the software from www.lightware.com/downloads.

Installation in case of Windows OS

Run the installer. If the User Account Control displays a pop-up message, click **Yes**.

Installation Modes

Normal install	Snapshot install
Available for Windows, macOS and Linux	Available for Windows only
The installer can update only this instance	Cannot be updated
One updateable instance may exist for all users	Many different versions can be installed for all users

ATTENTION! Using the default Normal install is highly recommended.

INFO: If you have a previously installed version, you will be prompted to remove the old version before installing the new one.

Installation in case of macOS

Mount the DMG file by double clicking on it, and drag the LDU2 icon over the Applications icon to copy the program into the Applications folder. If you want to copy LDU2 into another location, just drag the icon over the desired folder.

ATTENTION! Please check the firewall settings on the macOS device. LDC needs to be added to the exceptions of the blocked software for the proper operation.

INFO: This type of installer is equal to the **Normal install** of Windows.



Installation in case of Linux

Step 1. Download the **archive file** (tar.gz) from www.lightware.com and unpack it to a temp folder.

Step 2. Run the **install_ldu2.sh** file in the temp folder. The script will install LDU2 into the following folder: HOME/.local/share/lightware/ldu2.

Step 3. The folder above will contain this file: **LightwareDeviceUpdaterV2.sh** that can be used to start LDU2.

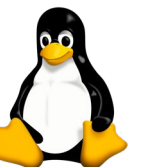

10.4. Running the Software

ATTENTION! The computer that runs LDU2 and the target device (that will be updated) must be in the same subnet. The update cannot be performed behind a firewall or gateway.

You have two options:

- Starting the LDU2 by double-clicking on the shortcut/program file, or
- Double-clicking on an LFP2 file.

10.4.1. LDU2 Interfaces

The software can be used over:

- The Graphical User Interface (GUI), or by
- The Command Line Interface (CLI).

LDU2 Auto-Update

At startup, the software checks if a newer version is available on the web.

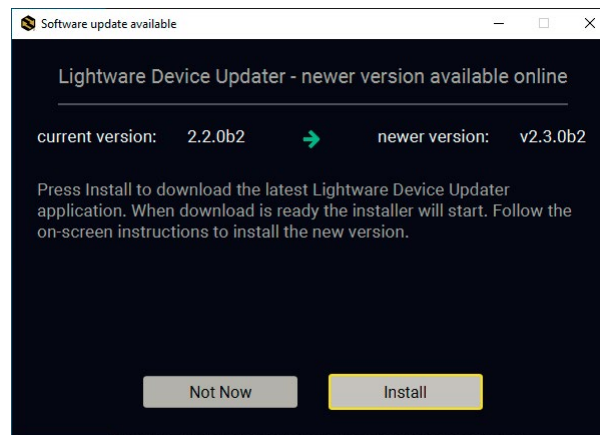

Main Screen

When the software is started via the shortcut, the device discovery screen appears. Press the **Search for devices** button to start finding the Lightware devices:

DISCOVER DEVICES

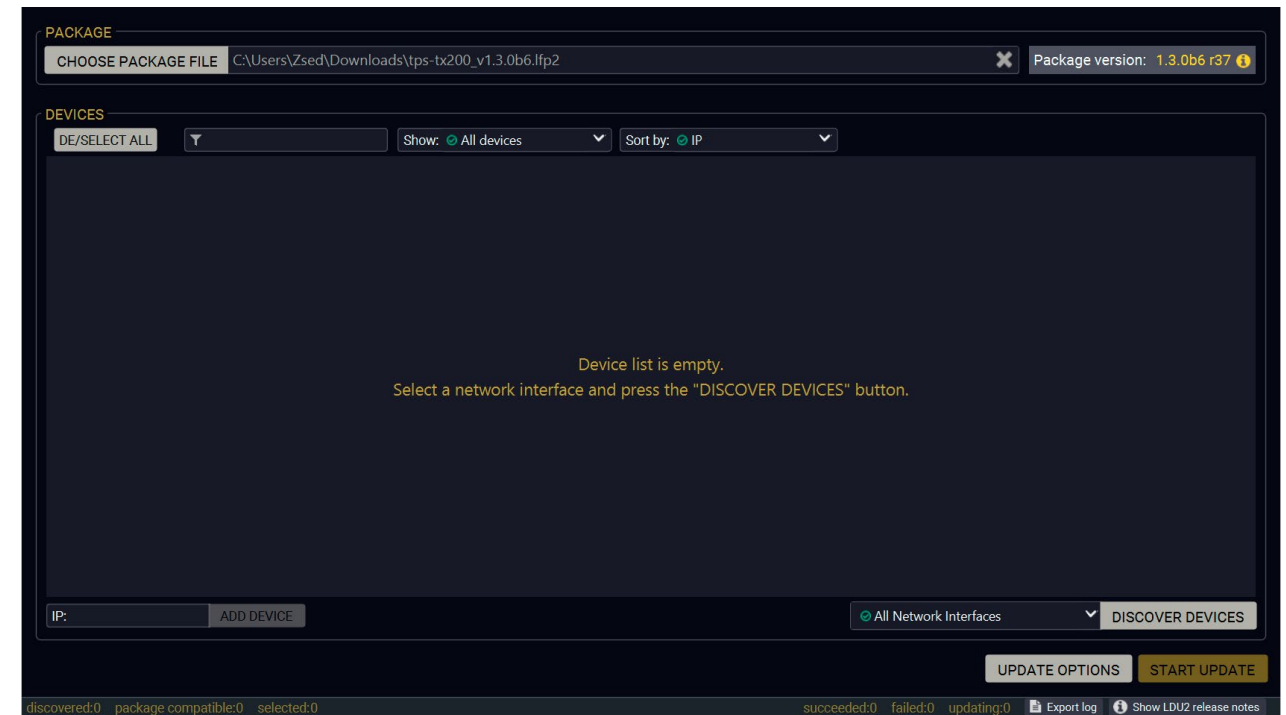

If you start the software by double-clicking on the LFP2 file, the firmware will be loaded. Press the **Discover devices** button; all the devices will be listed that are compatible with the selected firmware pack.

INFO: If you press the **Choose package file** button, the release notes of the LFP2 file will be displayed in the right panel; see the [Step 1. Select the Firmware Package](#) section.

Device List

When the discovery has completed, the devices available on the network are listed in the application.

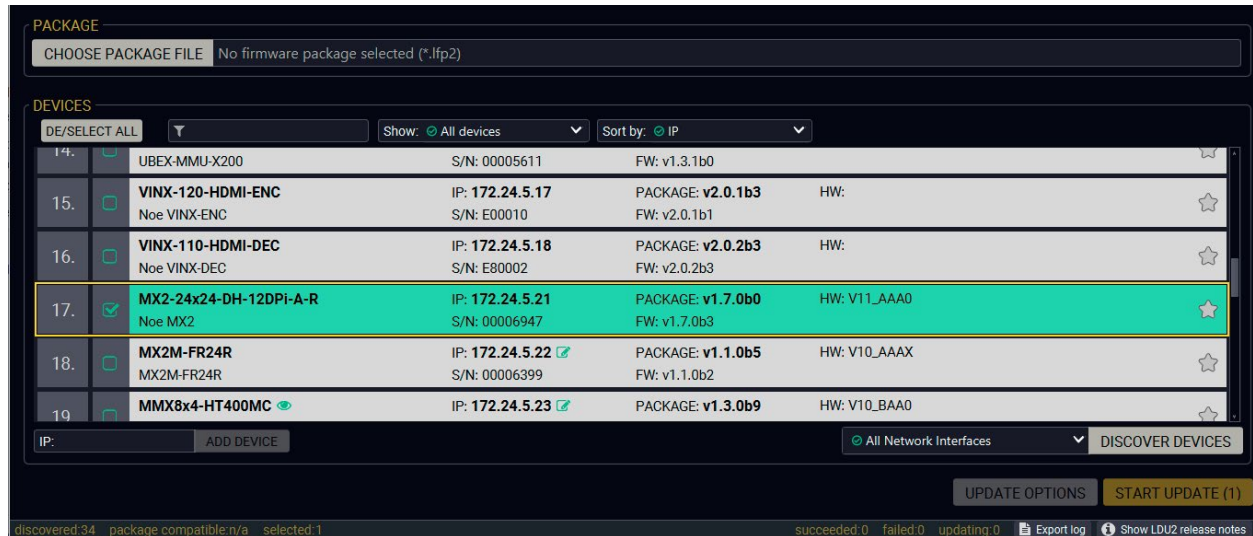

If the desired device is not discovered, you can add it by typing the IP address in the dedicated field and pressing the **Add device** button.

Legend of the Icons

	IP address editor	The IP address of the device can be changed in the pop-up window.
	Identify me	Clicking on the icon results in the front panel LEDs blinking for 10 seconds, which helps to identify the device physically.
	Favorite device	The device has been marked, thus the IP address is stored. When a device is connected with that IP address, the star will be highlighted in that line.
	Further information available	Device is unreachable. Change the IP address by pressing the IP address editor icon or use the front panel buttons (if available).
	Cleartext login enabled	The password-protection is enabled. You have to enter the password to perform the firmware update in the Parameters window or in the appearing window in the beginning of the update.
	Service mode	The device is in bootload mode. Backup and restore cannot be performed in this case.

10.5. The Updating Steps

ATTENTION! While the firmware is being updated, the normal operation mode is suspended, as the device is switched to bootload mode. Signal processing is not performed. Do not interrupt the firmware update. If any problem occurs, reboot the unit and restart the process.

Keeping the Configuration Settings

By default, device configuration settings are restored when firmware update is finished. If factory reset has been chosen in the parameters window, all device settings will be erased. In the case of factory reset, you can save the settings of the device in the Lightware Device Controller software and restore it later.

The following flow chart demonstrates how this function works in the background.

Step 1. Create a backup

The current configuration of the device is being saved into a configuration backup file on your computer.

Step 2. Start the Update

The device reboots and starts in bootload mode (firmware update mode).

Step 3. Upgrade

The CPU firmware is changed to the new one.

Step 4. Factory reset

All configuration settings are restored to the factory default values.

Step 5. Conversion / Restore

The firmware package checks the backup data before the restoration procedure, and if it is necessary, a conversion is applied to avoid incompatibility problems between the firmware versions. All configuration settings are restored to the device after the conversion.

If the factory default option is selected in the Parameters window, the conversion / restore procedure will not be performed!

Step 6. Finish

Once the firmware update procedure is finished, the device reboots and is ready to use.

10.6. Updating Via GUI

To update the desired device(s) via the Graphical User Interface follow, these steps.

Step 1. Select the Firmware Package

Click on the **Choose Package File** button and navigate to the location where the LFP2 file was saved. When you click on the name of package, the preview of the release notes are displayed in the right panel.

CHOOSE PACKAGE FILE

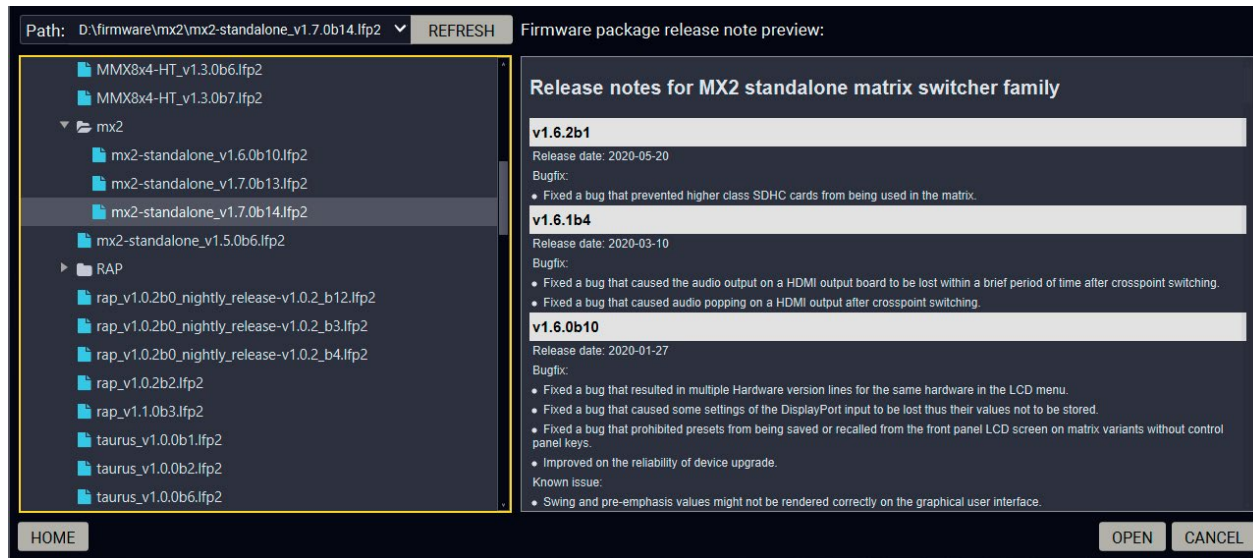

After the package file is loaded, the list is filtered to show the compatible devices only. The current firmware version of the device is highlighted in orange if it is different from the version of the package loaded.

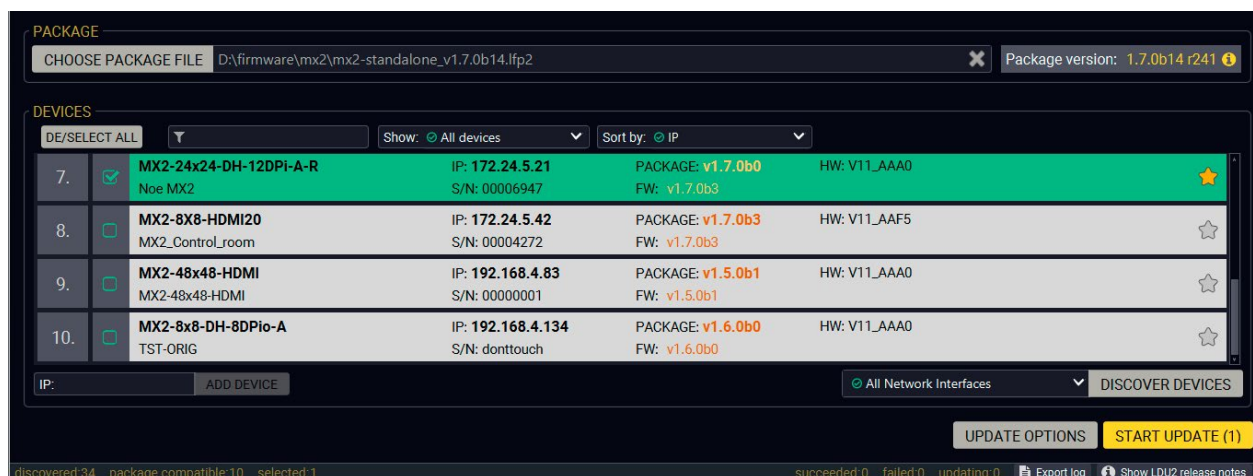

INFO: If you start the update by double-clicking on the LFP file, the screen above will be loaded right away.

The Meaning of the Symbols



The log about the updating process of the device can be displayed in a new window.

The device is in bootload mode. Backup and restore cannot be performed in this case.

Step 2. Select the desired devices for updating.

Select the devices for updating; the selected line will be highlighted in green.

If you are not sure which device to select, press the **Identify me** button. It makes the front panel LEDs blink for 10 seconds. The feature helps to find the device physically.

Step 3. Check the update parameters

DIFFERENCE: The appearing settings are device-dependent, and can be different device by device.

Clicking on the **Update Options** button, special settings will be available, such as:

UPDATE OPTIONS

- Creating a backup about the configuration,
- Restore the configuration or reloading the factory default settings after the firmware update,
- Uploading the default Miniweb (if available) #builtinweb #miniweb #web

Please arrange the settings carefully.

Step 4. Start the update and wait until it is finished

Click on the **Start Update** button to start the procedure. The status is shown in percent in the right side of the device line, and the overall process in the bottom progress bar. The update takes about 10-12 minutes to finish, which is independent of the number of the updated devices, since the updates are processed simultaneously.

START UPDATE

INFO: The device might reboot during the firmware update procedure.

The log about the updating process can be displayed in a new window by pressing the **Show details** button. When the progress bar reaches 100% (**Done** is displayed at all devices), the update of all devices are finished successfully and a message appears; you can close the software.

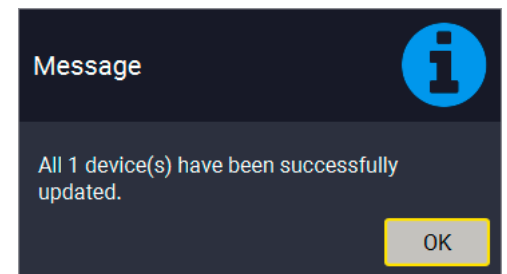

Step 5. Wait until the unit reboots with the new firmware

Once the firmware update procedure is completed, the device is rebooted with the new firmware. Shutting down and restarting the device is recommended.

10.7. Command Line Interface (CLI)

DIFFERENCE: The Command Line Interface is available from **LDU2 v2.9.0b9**.

The CLI of the LDU2 software is a simple tool for creating scriptable device updates without the need of human interactions. It allows batch updating with the same features that are available in case of GUI usage.

10.7.1. How to Run

Running under Windows® OS

The installer of LDU2 puts the following file into the installation folder:

LightwareDeviceUpdaterV2_CLI.cmd

CLI is available via this file, the exe is not suitable for that purpose. Open a command line window to execute or test the features directly.

Step 1. Open an Explorer window where the cmd file is located, the default is:

c:\Program Files (x86)\Lightware\Lightware Device Updater V2\LightwareDeviceUpdaterV2_CLI.cmd.

Step 2. Click on the address line (highlighted with blue in the picture), type `cmd.exe` and press enter. The command interpreter window of Windows is opened at the path of the LDU2 install folder.

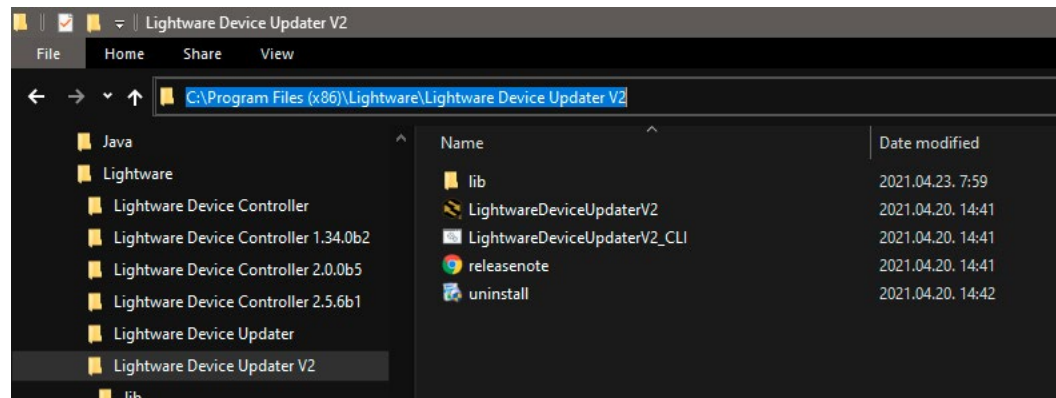

Step 3. Now you can use the `LightwareDeviceUpdaterV2_CLI.cmd` file with the commands and options, which are described in the coming sections:

Running under Linux

The Command Line Interface under Linux Operating Systems can be run by the following:

LightwareDeviceUpdaterV2.sh.

Running an update:

```
bash LightwareDeviceUpdaterV2.sh update --ip 172.24.5.27 --package ~/Downloads/mx2-standalone_v1.7.0b17.1fp2
```

The commands and options are the same under Windows® and Linux, too. Following sections contain examples with `LightwareDeviceUpdaterV2_CLI.cmd`.

10.7.2. How to Use

Command Structure

The commands can be run over CLI in the following way:

LightwareDeviceUpdaterV2_CLI.cmd [command] [options]

[Command]: a certain command described in the coming sections; only one command can be run at a time

[Options]: mandatory and/or optional parameters of the command, if any. Optional parameters have a default value, which can be found at each affected command. You only have to define the parameter if you want to apply a different value. The **order of the options** is arbitrary.

Important Notes

- CLI is **case-sensitive** (including commands, options and other parameters).
- There is **no limit** regarding the number of the devices to update. At most, 20 devices are updated simultaneously, when one of them is finished, the next (21st) will be started automatically.
- If an update is failed, the IP address of the affected device(s) are listed at the end.

10.8. CLI Commands

INFO: The commands and options described in the following sections are the same under Windows® and Linux, too. The examples contain `LightwareDeviceUpdaterV2_CLI.cmd`.

About the Examples

- Sent command is in **blue**, response is in **grey**.
- If the response in practice is **longer than listed** in the example, this symbol can be seen: `[...]`.

10.8.1. Help

The defined commands and options can be listed by the `help` command.

Command

```
LightwareDeviceUpdaterV2_CLI.cmd help
```

Example

```
C:\Program Files (x86)\Lightware\Lightware Device Updater V2>LightwareDeviceUpdaterV2_CLI.cmd help

C:\Program Files (x86)\Lightware\Lightware Device Updater V2>lib\jre\bin\java.exe -jar lib\ldu2.jar help
Command line usage:
  Win: LightwareDeviceUpdaterV2_CLI.cmd [command] [options]
  Linux: LightwareDeviceUpdaterV2.sh [command] [options]

Commands:
  * help
  * version
  * update
  * deviceInfo
  * restore
  * packageOptions

[...]
```

10.8.2. LDU2 Version

The response shows the version of the LDU2 and the version of the Script API (the Application Programming Interface that is used by the LDU2 and the script).

Command

```
LightwareDeviceUpdaterV2_CLI.cmd version
```

Example

```
C:\Program Files (x86)\Lightware\Lightware Device Updater V2>LightwareDeviceUpdaterV2_CLI.cmd version

C:\Program Files (x86)\Lightware\Lightware Device Updater V2>lib\jre\bin\java.exe -jar lib\ldu2.jar version
LDU2 version: 2.9.0b9
Script API version: 1.3.9
```

10.8.3. Checking For New LDU2 Version

The following command can be used to check if an update of LDU2 is available. This is just a request, since the CLI is not suitable for handling the complete installer of the software.

Command

```
LightwareDeviceUpdaterV2_CLI.cmd checkForUpdates
```

Example 1

```
c:\Program Files (x86)\Lightware\Lightware Device Updater V2>LightwareDeviceUpdaterV2_CLI.cmd checkForUpdates

c:\Program Files (x86)\Lightware\Lightware Device Updater V2>lib\jre\bin\java.exe -jar lib\ldu2.jar checkForUpdates
Current LDU2 version: 2.9.1b1
LDU2 is up-to-date
```

Example 2

```
c:\Program Files (x86)\Lightware\Lightware Device Updater V2>LightwareDeviceUpdaterV2_CLI.cmd checkForUpdates

c:\Program Files (x86)\Lightware\Lightware Device Updater V2>lib\jre\bin\java.exe -jar lib\ldu2.jar checkForUpdates
Current LDU2 version: 2.9.1b1
New version is available online: v2.9.2b2
Download URL: http://update.lightware.hu/ldu2/lwr/v2.9.2b2/install_LDU2_v2.9.2b2.exe
```

10.8.4. Device Info

The most important information about the selected device is displayed; see the example for more details.

Command

```
LightwareDeviceUpdaterV2_CLI.cmd deviceInfo [options]
```

Options

Option	Description	Required?
-i or --ip	List of IP addresses of devices to be updated	one of them is mandatory
-n or --hostName	List of host names of devices to be updated	mandatory
-v or --packageVersion	Shows installed package version only	optional

Example 1

```
C:\Program Files (x86)\Lightware\Lightware Device Updater V2>LightwareDeviceUpdaterV2_CLI.cmd deviceInfo --ip 192.168.1.12

C:\Program Files (x86)\Lightware\Lightware Device Updater V2>lib\jre\bin\java.exe -jar lib\ldu2.jar deviceInfo --ip 192.168.1.12
Product name: MX2-8x8-HDMI20-Audio
IP address: 192.168.1.12
Serial number: 00002263
MAC address: a8:d2:36:ff:22:63
Part number: 91540065
Device label: 123
Package version: v1.3.0b6
CPU FW version: v1.3.0b3
HW version: V12_KAA0
Operation mode: Application mode
```

Example 2

```
C:\Program Files (x86)\Lightware\Lightware Device Updater V2>LightwareDeviceUpdaterV2_CLI.cmd deviceInfo --ip 192.168.1.12 --packageVersion

C:\Program Files (x86)\Lightware\Lightware Device Updater V2>lib\jre\bin\java.exe -jar lib\ldu2.jar deviceInfo --ip 192.168.1.12 --packageVersion
v1.3.0b6
```

10.8.5. Update

This command can be used to update the firmware of the devices.

Command

```
LightwareDeviceUpdaterV2_CLI.cmd update [options]
```

Options

Option	Description	Required?
-p or --package	The path of the firmware package file	yes
-i or --ip	List of IP addresses of devices to be updated	one of them is mandatory
-n or --hostName	List of host names of devices to be updated	
-b or --backupFolder	Folder to create device configuration backup at. Default: USER_HOME/.ldu2/backup	optional
-f or --factoryDefault	Apply factory reset during device update. Default: false	optional
-r or --reportProgress	Report update progress in percent. Default: false	optional
Package-specific options	Certain LFP2 packages have features that can be applied at this command; see the Package Options section.	optional

ATTENTION! The configuration is restored automatically if the factory default option is not applied in the **update** command. In that case, there is no need to run the **restore** command after the update.

Example

```
C:\Program Files (x86)\Lightware\Lightware Device Updater V2>LightwareDeviceUpdaterV2_CLI.cmd update --ip 192.168.1.12 --package C:\Firmwares\mx2-standalone_v1.7.0b17.lfp2 --reportProgress

C:\Program Files (x86)\Lightware\Lightware Device Updater V2>lib\jre\bin\java.exe -jar lib\ldu2.jar update --ip 192.168.1.12 --package C:\Firmwares\mx2-standalone_v1.7.0b17.lfp2 --reportProgress
[2021-05-12 08:59:36.336] [ INFO] [          main] - Device IPs: [192.168.1.12]
[2021-05-12 08:59:39.409] [ INFO] [          main] - All the selected devices are accessible over the network.
[2021-05-12 08:59:39.628] [ INFO] [          main] - All the selected devices are compatible with the specified package.
[2021-05-12 08:59:40.025] [ INFO] [ 192.168.1.12] - Package version: 1.3.2b3
[2021-05-12 08:59:40.092] [ INFO] [ 192.168.1.12] - Login functionality is currently not enabled.
[2021-05-12 08:59:40.129] [ INFO] [ 192.168.1.12] - Creating backup of device settings...
[2021-05-12 08:59:43.582] [ INFO] [ 192.168.1.12] - Backup HTTP enable properties
[2021-05-12 08:59:44.638] [ INFO] [ProgressReporter] - Progress: 2%
[2021-05-12 08:59:46.111] [ INFO] [ 192.168.1.12] - HTTP and HTTP post have got enabled on port 80
[2021-05-12 08:59:46.319] [ INFO] [ 192.168.1.12] - No miniweb file is found on the device.
[2021-05-12 08:59:48.890] [ INFO] [ 192.168.1.12] - HTTP and HTTP post properties have got restored on port 80
[2021-05-12 08:59:48.897] [ INFO] [ 192.168.1.12] - Switching device into bootload mode...
[2021-05-12 08:59:49.640] [ INFO] [ProgressReporter] - Progress: 5%
[...]
```

The lines containing "ProgressReporter" can be enabled optionally. If it is enabled, the current state is displayed in every 5 seconds.

10.8.6. Restore

Restores device configuration from a backup file.

TIPS AND TRICKS: This command can be used for uploading a configuration to numerous devices (aka Configuration cloning by CLI).

Command

```
LightwareDeviceUpdaterV2_CLI.cmd restore [options]
```

Options

Option	Description	Required?
-i or --ip	List of IP addresses of devices to be updated	one of them is mandatory
-n or --hostName	List of host names of devices to be updated	
-b or --backupFile	The path of the configuration backup file	yes
-k or --keepOriginalIp	Do not override the network settings of the device with the ones in the backup file. It comes in handy when multiple devices' configuration is being restored from a single backup file. Default: false	optional

ATTENTION! The configuration is restored automatically if the factory default option is not applied in the **update** command. In that case, there is no need to run the **restore** command after the update.

Example

```
C:\Program Files (x86)\Lightware\Lightware Device Updater V2>LightwareDeviceUpdaterV2_CLI.cmd restore --ip 192.168.1.12 --backupFile C:\mybackup.lw3 --keepOriginalIp

C:\Program Files (x86)\Lightware\Lightware Device Updater V2>lib\jre\bin\java.exe -jar lib\ldu2.jar restore --ip 192.168.1.12 --backupFile C:\mybackup.lw3 --keepOriginalIp
[2021-05-12 10:49:36.412] [ INFO] [          main] - Executing configuration restore...
[2021-05-12 10:49:36.425] [ INFO] [          main] - Device IPs: [192.168.1.12]
```

INFO: The firmware package checks the backup data before the restoration procedure, and if it is necessary, a conversion is applied to avoid incompatibility problems between the firmware versions. In that case, two backup files are created: the original, and a new one with "_converted" suffix. Using the last one for restoring is recommended.

10.8.7. Package Options

Shows package-specific update options.

Command

```
LightwareDeviceUpdaterV2_CLI.cmd packageOptions [options]
```

Options

Option	Description	Required?
-p or --package	The path of the firmware package file	yes

Example

```
C:\Program Files (x86)\Lightware\Lightware Device Updater V2>LightwareDeviceUpdaterV2_CLI.cmd packageOptions
--package c:\Firmwares\mx2-standalone_v1.7.0b17.lfp2

C:\Program Files (x86)\Lightware\Lightware Device Updater V2>lib\jre\bin\java.exe -jar lib\ldu2.jar packageOptions
--package c:\Firmwares\tps-tx200_v1.3.2b3.lfp2

Backup and restore options:
  --skipPresetsAtRestore : if true, device presets will not be restored. (Default: false)
  --uploadDefaultMiniWeb : if true and no custom miniweb is present on the device, the default built-in
miniweb will be uploaded to the device. (Default: false)

Test options:
  --test : if true, no update will be performed, communication with the device will be tested. (Default:
false)
```

Package option example can be seen in the following section.

10.8.8. Complex Examples

The following options are applied:

- Firmware is updated
- Factory default settings are restored

```
C:\Program Files (x86)\Lightware\Lightware Device Updater V2>LightwareDeviceUpdaterV2_CLI.cmd update --ip
192.168.1.12 --factoryDefault --package c:\Firmwares\mx2-standalone_v1.7.0b17.lfp2

C:\Program Files (x86)\Lightware\Lightware Device Updater V2>lib\jre\bin\java.exe -jar lib\ldu2.jar update --ip
192.168.1.12 --factoryDefault --package c:\Firmwares\mx2-standalone_v1.7.0b17.lfp2
[2021-05-12 11:22:09.089] [ INFO] [          main] - Device IPs: [192.168.1.12]
[2021-05-12 11:22:12.947] [ INFO] [          main] - All the selected devices are accessible over the network.
[2021-05-12 11:22:13.225] [ INFO] [          main] - All the selected devices are compatible with the specified
package.
[2021-05-12 11:22:13.777] [ INFO] [ 192.168.1.12] - Package version: 1.3.2b3
[2021-05-12 11:22:13.878] [ INFO] [ 192.168.1.12] - Login functionality is currently not enabled.
[2021-05-12 11:22:13.896] [ INFO] [ 192.168.1.12] - Switching device into bootload mode...
[2021-05-12 11:22:34.519] [ INFO] [ 192.168.1.12] - Gathering UID information from device...
[2021-05-12 11:22:35.097] [ INFO] [ 192.168.1.12] - UID info - Device IP: 192.168.1.12 Product name: MX2-
16x16-DH-8DPi-A-R Product part number: 91310068 Serial number: 00002263 Hardware version: V12_KAA0 MAC address:
A8:D2:36:FF:22:63
[2021-05-12 11:22:35.589] [ INFO] [ 192.168.1.12] - Package version on device: 1.3.2b3 r44
[2021-05-12 11:22:35.626] [ INFO] [ 192.168.1.12] - Updating MX2 Standalone series application fw part 1...
[2021-05-12 11:22:36.123] [ INFO] [ 192.168.1.12] - [mx2.bin.ER_IROM1]'s current version on device: 1.3.1b1 r35
[2021-05-12 11:22:36.124] [ INFO] [ 192.168.1.12] - [mx2.bin.ER_IROM1]'s version in the package: 1.3.1b1 r35
[2021-05-12 11:22:52.439] [ INFO] [ 192.168.1.12] - [tps_tx200.bin.ER_IROM1]'s firmware version updated in FVS
EEPROM.
[2021-05-12 11:22:52.442] [ INFO] [ 192.168.1.12] - Updating VS100TX fw...
[2021-05-12 11:22:52.920] [ INFO] [ 192.168.1.12] - [vs100_tx.bin]'s current version on device: 1.1.0b0 r0
[2021-05-12 11:22:52.921] [ INFO] [ 192.168.1.12] - [vs100_tx.bin]'s version in the package: 1.1.0b0 r63
[2021-05-12 11:23:06.423] [ INFO] [ 192.168.1.12] - [vs100_tx.bin]'s firmware version updated in FVS EEPROM.
[2021-05-12 11:23:06.425] [ INFO] [ 192.168.1.12] - Updating MX2 Standalone series application fw part 2...
[2021-05-12 11:23:06.903] [ INFO] [ 192.168.1.12] - [mx2.bin.ER_IROM2]'s current version on device: 1.3.1b1 r35
[2021-05-12 11:23:06.904] [ INFO] [ 192.168.1.12] - [mx2.bin.ER_IROM2]'s version in the package: 1.7.0b17 r35
[2021-05-12 11:23:27.858] [ INFO] [ 192.168.1.12] - [mx2.bin.ER_IROM2]'s firmware version updated in FVS
EEPROM.
[2021-05-12 11:23:27.860] [ INFO] [ 192.168.1.12] - Updating PS171 FW...
[2021-05-12 11:23:28.338] [ INFO] [ 192.168.1.12] - [mx2_family_ps171.bin]'s current version on device: 1.0.6b0
r0
[2021-05-12 11:23:28.340] [ INFO] [ 192.168.1.12] - [mx2_family_ps171.bin]'s version in the package: 1.7.0b17
r522
[2021-05-12 11:23:44.810] [ INFO] [ 192.168.1.12] - [mx2_family_ps171.bin]'s firmware version updated in FVS
EEPROM.
[2021-05-12 11:23:51.412] [ INFO] [ 192.168.1.12] - Setting system information...
[2021-05-12 11:23:57.994] [ INFO] [ 192.168.1.12] - Starting application...
[2021-05-12 11:25:44.239] [ INFO] [ 192.168.1.12] - Done

All 1 update(s) finished successfully.
```

10.8.9. Exit Codes

There is a return value in all cases, when a command run is finished. Currently, three codes are defined:

Code	Displayed text	Description
0	N/A	The update performed successfully
1	Update error (ErrorCode:1)	The error happened during the update
2	CLI error (ErrorCode:2)	The error happened before starting the update

The error line contains further information about the error.

Querying the Exit Code under Windows®

```
c:\Program Files (x86)\Lightware\Lightware Device Updater V2\echo %errorlevel%
0
```

Querying the Exit Code under Linux

```
echo $?
0
```

If this value is queried after the update and it is 0, the update performed successfully.

10.9. If the Update is not successful

- Restart the process and try the update again.
- If the device cannot be switched to bootload (firmware update) mode, you can do that manually as written in the User's manual of the device. Please note that backup and restore cannot be performed in this case.
- If the backup cannot be created for some reason, you will get a message whether to continue the process without backup or stop the update. A root cause can be that the desired device is already in bootload (firmware update) mode, thus the normal operation mode is suspended and backup cannot be made.
- If an update is not successful, the **Export log** button becomes red. If you press the button, you can download the log file as a ZIP package, which can be sent to Lightware Support if needed. The log files contain useful information about the circumstances to find the root cause. *#bootload*





11

Troubleshooting

Usually, if the system seems not to transport the signal as expected, the best strategy for troubleshooting is to check signal integrity through the whole signal chain starting from source side and moving forward to receiver end.

At first, check front panel LEDs and take the necessary steps according to their states. For more information about front panel LEDs of the matrix, see the [Product Overview](#) section.



















Pictogram Legend























-  Section to connections/cabling.
-  Section to front panel operation.
-  Section to LDC software.
-  Section to LW2 protocol commands.
-  Section to LW3 protocol commands.

The following sections are available in the chapter:

- ▶ [USE CASES](#)
- ▶ [HOW TO SPEED UP THE TROUBLESHOOTING PROCESS](#)

11.1. Use Cases

Symptom	Root cause	Action	Refer to
Video signal			
No picture on the video output	Device(s) not powered properly	Check the matrix and the other devices if they are properly powered; try to unplug and reconnect them.	 4.3
	Cable connection problem	Cables must fit very well, check all the connectors.	 4.3
	No incoming signal	No video signal is present on the HDMI input ports. Check the source device and the HDMI cables.	 4.3
	Not the proper video port is the active one	Check the video crosspoint settings.	 3.1.1  7.4  8.4  9.5.1
	Not the proper interface is the active one	If the source/display has more connectors, check if the proper interface is selected.	
	Output port is muted	Check the mute state of output ports.	 7.6  8.4.6  9.8.1
	Display is not able to receive the video format	Check the emulated EDID and select another (e.g. emulate the display’s EDID on the input port).	 3.2.4  7.8  9.14
	HDCP is disabled	Enable HDCP on input port(s) of the matrix.	 6.4.1  9.5.6
No picture on the video output + signal error rate is high, HDMI2.0 scrambling is disabled, clock rate is set 1:10	The source sends 4K signals, but the emulated EDID does not support this resolution.	Check the emulated EDID and select another (e.g. F139 EDID on the input port).	 3.2.4  7.8  9.14

Symptom	Root cause	Action	Refer to
Audio signal			
No audio is present on output	Other audio port is switched to the output	Check the audio crosspoint settings.	 3.1  7.4.1  8.4.5  9.7.1
	Output port is muted	Check the output port properties.	 3.2.3  7.6  8.4.6  9.8.1
	Analog audio input: volume is set very low	Check the Analog audio input port settings (Volume).	 3.2.2  7.5.1  9.7.2
	Analog audio output: volume is set very low	Check the Analog audio output port settings (Volume).	 3.2.3  7.6  9.11.2
	HDMI mode was set to DVI	Check the properties of the output port and set to HDMI or Auto.	 3.2.3  7.6  9.9.1
HDMI output signal contains no audio	DVI EDID is emulated	Check the EDID and select an HDMI EDID to emulate.	 3.2.4  6.6  9.14
Symptom	Root cause	Action	Refer to
RS-232 signal			
Connected serial device cannot be controlled	Cable connection problem	Check the connectors to fit well; check the wiring of the plugs.	 4.2
	Serial settings are different	Check the port settings of the matrix and the connected serial device(s). Pay attention to link and/or local ports.	 7.9.3  9.15

Ethernet				
No LAN connection can be established	Incorrect IP address is set (direct connect)	Disable DHCP server and set the IP addresses to be in the same subnet.	7.9.2 LW3 9.13	
		Restore the factory default settings (with fix IP).	7.9.5 LW3 9.4.5	
	IP address conflict	Change the IP address to a not reserved one or enable DHCP if DHCP server exists in the network.	3.2.1	7.9.2
			LW3 9.13	

11.2. How to Speed Up the Troubleshooting Process

Lightware's technical support team is always working hard to provide the fastest support possible. Our team's response time is one of the best in the industry, and in the toughest of cases, we can directly consult with the hardware or software engineer who designed the product to get the information from the most reliable source.

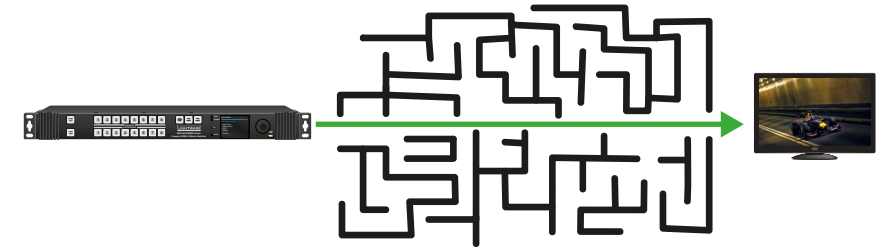

However, the troubleshooting process can be even faster... with your help.

There are certain pieces of information that push us in the right direction to find the root cause of the problem. If we receive most of this information in the first e-mail, or it is gathered at the time when you call us, then there is a pretty high chance that we will be able to respond with the final solution right away.

This information is the following:

- Schematic (a pdf version is preferred, but a hand drawing is sufficient).
- Serial number(s) of the device(s) (it is either printed somewhere on the box or you can query it in the Device Controller software or on the built-in website).
- Firmware versions of the devices (please note that there may be multiple CPUs or controllers in the device and we need to know all of their firmware versions, a screenshot is the best option).
- Cable lengths and types (in our experience, it's usually the cable).
- Patch panels, gender changers or anything else in the signal path that can affect the transmission.
- Signal type (resolution, refresh rate, color space, deep color).
- Emulated EDID(s) (please save them as a file and send it to us).
- Actions to take in order to re-create the problem (if we cannot reproduce the problem, it is hard for us to find the cause).
- Photo or video about the problem ('image noise' can mean many different things, it's better if we see it too).
- Error logs from the Device Controller software.
- In the case of Event Manager issue the event file and/or backup file from the Device Controller software.

The more of the information above you can give us, the better. Please send this information to the Lightware Support Team (support@lightware.com) to speed up the troubleshooting process.

12

Technologies

The following sections contain descriptions and useful technical information on how the devices work in the background. The content is based on experiences and cases we met in the practice. These sections help to understand features and technical standards like the following:

- ▶ [EDID MANAGEMENT](#)
- ▶ [HDCP MANAGEMENT](#)
- ▶ [PIXEL ACCURATE RECLOCKING](#)
- ▶ [SERIAL MANAGEMENT](#)

12.1. EDID Management

12.1.1. Understanding the EDID

The Extended Display Identification Data (EDID) is the passport of display devices (monitors, TV sets, projectors). It contains information about the capabilities of the display, such as supported resolutions, refresh rates (these are called Detailed Timings), the type and manufacturer of the display device, etc.

After connecting a source to a display (DVI, HDMI, DP), the source reads out the EDID to determine the resolution and refresh rate of the image to be transmitted.

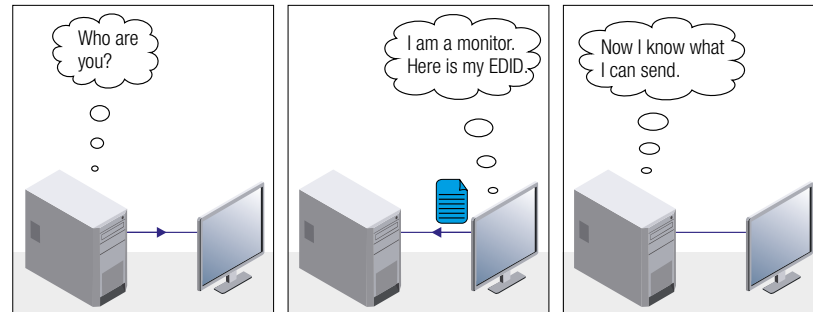

EDID Communication

Most DVI computer displays have 128-byte-long EDID structure. However, Digital Televisions and HDMI capable displays may have another 128 bytes, which is called E-EDID and is defined by CEA (Consumer Electronics Association). This extension contains information about additional Detailed Timings, audio capabilities, speaker allocation and HDMI capabilities. It is important to know that all HDMI capable devices must have CEA extension, but not all devices with CEA extension are HDMI capable.

Common Problems Related to EDID

Problem: “My system consists of the following: a computer, a Lightware device, a WUXGA (1920x1200) LCD monitor, and an SXGA (1280x1024) projector. I would like to see the same image on the monitor and the projector. What EDID should I choose on the Lightware device?”

Solution: If you want to see the image on both displays, you need to select the resolution of the smaller display (in this case SXGA), otherwise the smaller display may not show the higher resolution image.

Problem: “I have changed to a different EDID on an input port of the Lightware device to have a different resolution, but nothing happens.”

Solution: Some graphics cards and video sources read out the EDID only after power-up and later they do not sense that EDID has been changed. You need to restart your source to make it read out the EDID again.

12.1.2. Advanced EDID Management

Each DVI sink (e.g. monitors, projectors, plasma displays, etc...) must support the EDID data structure. Source BIOS and operating systems are likely to query the sink using DDC2B protocol to determine what pixel formats and interface are supported. DVI standard uses EDID data structure to identify the monitor type and capabilities. Most DVI sources (VGA cards, set top boxes, etc.) will output DVI signal after accepting the connected sink's EDID information. In the case of EDID readout failure or missing EDID, the source will not output DVI video signal.

Lightware devices provide the Advanced EDID Management function that helps system integration. The built-in EDID Router can store and emulate factory pre-programmed- and User programmable EDIDs. The EDID of the attached monitors or projectors for each output are stored in a non-volatile memory. This way the EDID of a monitor is available when the monitor is unplugged or switched off.

Any EDID can be emulated on any input. An emulated EDID can be copied from the EDID router's memory (static EDID emulation), or from the last attached monitor's memory (dynamic EDID emulation). For example, the Lightware device can be set up to emulate a sink device, which is connected to one of the outputs. In this case, the EDID automatically changes, if the monitor is replaced with another display device (as long as it has a valid EDID).

EDID is independently programmable for all inputs without affecting each other. All inputs have their own EDID circuit.

INFO: The user is not required to disconnect the video cable to change an EDID as opposed to other manufacturer's products. EDID can be changed even if a source is connected to the input and powered ON.

INFO: When EDID has been changed, the router toggles the HOTPLUG signal for 2 seconds. Some sources do not sense this signal. In such cases, the source device must be restarted or powered OFF and ON again.

12.2. HDCP Management

Lightware Visual Engineering is a legal HDCP adopter. Several functions have been developed that help to solve HDCP related problems. Complex AV systems often have both HDCP and non-HDCP components. The matrix allows transmitting HDCP encrypted and unencrypted signals. The devices will be still HDCP compliant as they will never output an encrypted signal to a non-HDCP compliant display device. If an encrypted signal is switched to a non-compliant output, a blank (or red) screen alert or muted screen will appear.

12.2.1. Protected and Unprotected Content

Many video sources send HDCP protected signal if they detect that the sink is HDCP capable – even if the content is not copyrighted. This can cause trouble if an HDCP capable device is connected between the source and the display. In this case, the content cannot be viewed on non-HDCP capable displays and interfaces like event controllers. Rental and staging technicians often complain about certain laptops, which are always sending HDCP encrypted signals if the receiver device (display, matrix router, etc.) reports HDCP compliancy. Even though HDCP encryption is not required all the time (e.g. computer desktop image), certain laptops still do that.

To avoid unnecessary HDCP encryption, Lightware introduced the HDCP enabling/disabling function: the HDCP capability can be disabled in the Lightware device. If HDCP is disabled, the connected source will detect that the sink is not HDCP capable, and turn off authentication.

12.2.2. Disable Unnecessary Encryption

HDCP Compliant Sink



All the devices are HDCP-compliant, no manual setting is required, both protected and unprotected contents are transmitted and displayed on the sink.

Not HDCP-compliant Sink 1.



Non-HDCP compliant sink is connected to the matrix. Some sources (e.g. computers) always send HDCP encrypted signals if the receiver device reports HDCP compliancy, however, HDCP encryption is not required all the time (e.g. computer desktop image). If HDCP is enabled in the matrix, the image will not be displayed on the sink.

Setting the HDCP parameter to Auto on the output port and disable HDCP on the input port, the transmitted signal will not be encrypted if the content is not protected. Thus, non-HDCP compliant sinks will display non-encrypted signal.

Not HDCP-compliant Sink 2.



The layout is the same as in the previous case: non-HDCP compliant display device is connected to the matrix but the source would send protected content with encryption. If HDCP is enabled on the input port of the matrix, the source will send encrypted signal. The sink is not HDCP compliant, thus, it will not display the video signal (but blank/red/muted/etc. screen). If HDCP is disabled on the input port of the matrix, the source will not send the signal. The solution is to replace the display device to an HDCP-capable one.

12.2.3. HDCP v2.2

HDCP v2.2 is the latest evolution of copy protection. It is designed to create a secure connection between a source and a display. The 2.x version of HDCP is not a continuation of HDCPv1, and is rather a completely different link protection. One of the main differences is the number of the allowed devices within a closed AV system: HDCP v2.2 allows 32 devices (HDCP v1.4 allows 128 devices). A further limit is that up to four level is allowed, which means the protected signal can be transmitted over at most four repeater/matrix/switcher device. HDCP content protection is activated only if an active video stream is transmitted from the source to the display. The encryption is not activated without a video signal.

HDCP v2.2 standard allows the application of a previous version of HDCP (e.g. HDCP v1.4) between the source and the display if the source device allows it. According to the standard, if the image content is protected with HDCP, the highest supported content protection level has to be applied. However, if the highest level of protection is not justified by the source content, the level may be decreased to avoid compatibility problems; this case is determined by the source.

HDCP v2.2 Source and HDCP v1.4 Sink

In this case the signal of an HDCP v2.2 compliant source is switched to an HDCP v1.4 compliant sink device. The signal is encrypted with HDCP v2.2 on the input and encrypted with HDCP v1.4 on the output of the Lightware device. A lower level of encryption may be applied only if the source device/content allows it - according to the HDCP standard. In this case the HDCP settings are:



	INPUT	OUTPUT
HDMI port	Allow HDCP 2.2 and HDCP 1.4	Depends on input or Maximum possible
DP port	Allow HDCP 2.2 and HDCP 1.4	Auto or Always

HDCP v1.4 Source and HDCP v2.2 Sink

The example below is the reversal of the previous case. An HDCP v1.4 compliant source sends a signal with HDCP v1.4 encryption. The signal is switched to an HDCP v2.2 compliant sink device. In this case the outgoing signal has to be encrypted with the highest supported encryption level towards the sink, as the Lightware device and the sink are both HDCP v2.2 compliant. The HDCP v2.2 standard does not allow keeping the original HDCP v1.4 encryption level on the output.



What Kind of Signal Will be on the Output of the Lightware Device?

See below table that summarizes the possible cases:

Incoming Signal	HDCP v1.4 Compatible Sink on the Output	HDCP v2.2. Compatible Sink on the Output
HDCP v1.4	HDCP v1.4	HDCP v2.2
HDCP v2.2 (convertible) *	HDCP v1.4	HDCP v2.2
HDCP v2.2 (not convertible) *	Blank (or red) screen	HDCP v2.2

* Stream type 0: the video stream allowsthe conversion of the signal to apply a lower level of encryption.

** Stream type 1: the video stream does not allow the conversion of the signal.

12.3. Pixel Accurate Reclocking

Signal reclocking is an essential procedure in digital signal transmission. After passing the reclocking circuit, the signal becomes stable, jitter-free, and can be transmitted over more equipment like processors, or event controllers. Without reclocking, sparkles, noise, and jaggies appear on the image.

Lightware’s sophisticated Pixel Accurate Reclocking technology fixes more problems than general TMDS reclocking. It removes not only intra-pair skew, but inter-pair skew as well. The Pixel Accurate Reclocking circuit eliminates the following errors:

Intra-pair skew

Skew between the + and - wires within a differential wire pair (e.g. Data2- and Data2+). It’s caused by different wire lengths or slightly different wire construction (impedance mismatch) in the DVI cable. It results in jitter.

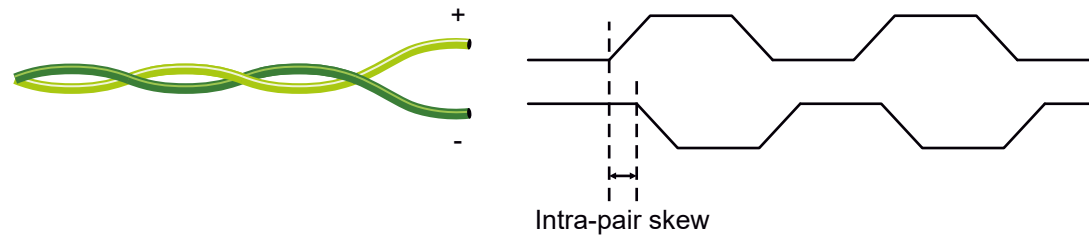

Inter-pair skew

Skew between two differential wire pairs in a cable. It is caused by different wire pair lengths or different number of twists in the DVI cable. Too much inter-pair skew results in color shift in the picture or sync loss.

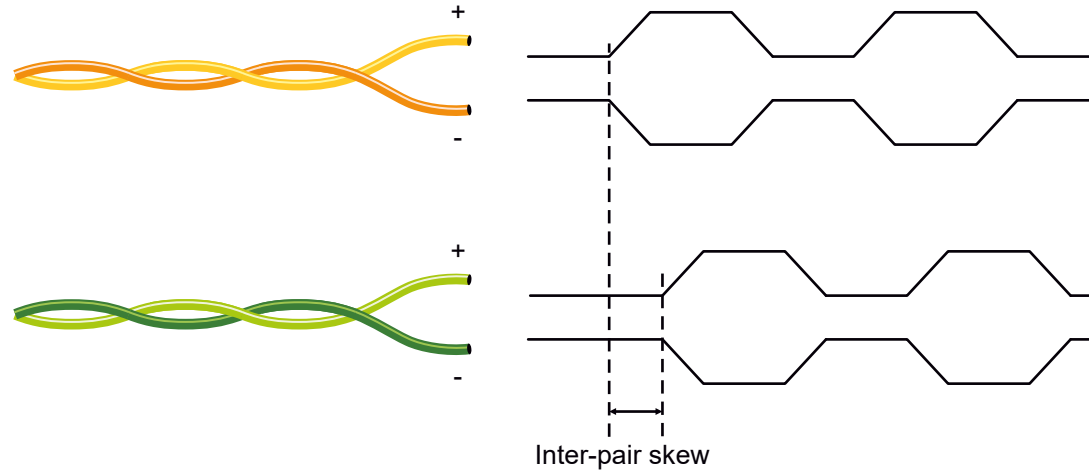

Jitter

Signal instability in the time domain. The time difference between two signal transitions should be a fixed value, but noise and other effects cause variations.

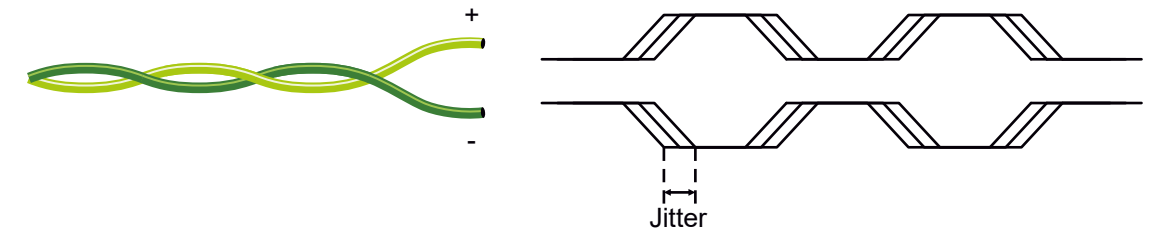

Noise

Electromagnetic interference between other electronic devices such as mobile phones, motors, etc. and the DVI cable are coupled onto the signal. Too much noise results in increased jitter.

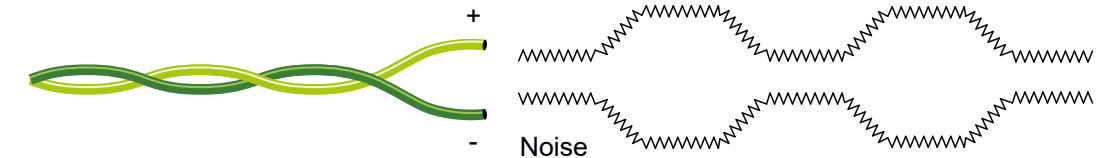

INFO: The colors of the wire pairs in the pictures are for illustration and do not represent the color of the actual wires inside the cable.

12.4. Serial Management

12.4.1. General Information

There are two types of devices in general serial communication:

- **Data Terminal Equipment:** Data Terminal Equipment (DTE) is an end instrument that converts user information into signals or reconverts received signals. Typical DTE devices: computers, LCD touch panels and control systems.
- **Data Circuit-terminating Equipment:** Data Circuit-terminating Equipment (DCE) is a device that sits between the DTE and a data transmission circuit. It is also called data communication equipment and data carrier equipment. Typical DCE devices: projectors, industrial monitors and amplifiers.

Among others, the pin assignment is different between DTE and DCE.

	DTE	DCE
Pin 2:	RD	TD
Pin 3:	TD	RD



RD: Received Data (digital input)
TD: Transmitted Data (digital output)

Different type of serial cables must be used between different serial devices.

	DTE	DCE
DTE	Null-modem	Straight
DCE	Straight	Null-modem *

* In general, contact DCE with DCE by tail-circuit serial cable.

12.4.2. Types of Serial Cables

Straight Serial Cable	Null-modem Serial Cable
Straight pin-outs both ends.	Straight pin-out at the one end and cross pin-out at the other end (interchange lines of TX and RX).
	

Serial cables between devices may have male or female plugs and their type may be straight or null-modem in usual.

ATTENTION! The cable type does not depend on the plug type.

12.4.3. RS-232 Signal Transmission over MX2 Matrix switchers

The following examples describe the detailed integration of Lightware devices between different RS-232 pin assignment units.

INFO: -R suffixed models in MX2-HDMI20 series are supplied with D-SUB serial connector. These models are DCE units (according to their pinouts) with female plugs.

Extending RS-232 between DTE and DCE Third-party Devices

Connect straight serial cable between controller system (DTE) and the matrix (DCE).

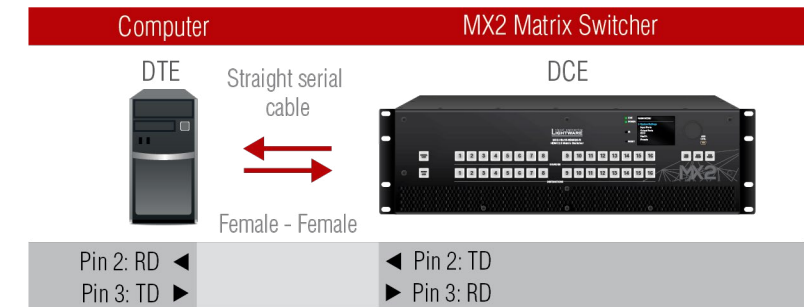

RS-232 Connection Example between a Controller System and a Matrix Switcher

Extending RS-232 between DTE and DTE Third-party Devices

Connect a null-modem serial cable between a projector (DCE) and a matrix (DCE).

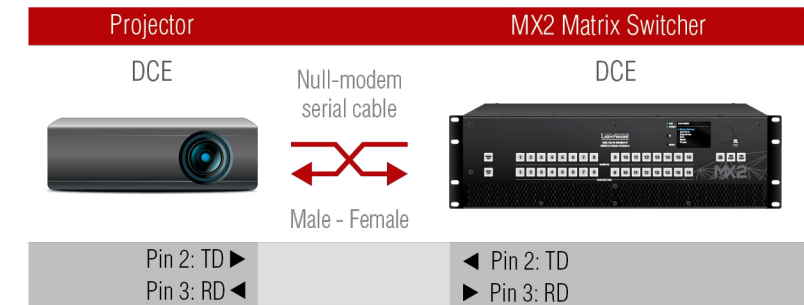

RS-232 Connection Example between a Projector and a Matrix Switcher

13

Appendix

Tables, drawings, guides, technical details and the hashtag keyword list as follows:

- ▶ SPECIFICATIONS
- ▶ APPLIED PORTS (NETWORK SETTINGS)
- ▶ FACTORY DEFAULT SETTINGS
- ▶ MECHANICAL DRAWINGS
- ▶ CABLE WIRING GUIDE
- ▶ FACTORY EDID LIST
- ▶ FRONT AND REAR VIEWS WITH PORT NUMBERING
- ▶ DIRECTION OF THE AIRFLOW
- ▶ RELEASE NOTES OF THE FIRMWARE PACKAGES
- ▶ **HASHTAG KEYWORD LIST**
- ▶ FURTHER INFORMATION

13.1. Specifications

INFO: Specifications are subject to change without notice.

General

Compliance	CE, UKCA, UL
EMC (emission)	EN 55032:2015+A1:2020
EMC (immunity)	EN 55035:2017+A11:2020
RoHS	EN 63000:2018
Electrical safety	EN 62368-1:2014 Second Edition
Warranty	3 years
Operating temperature	0° to +50°C (+32° to +122°F)
Storage temperature	-20 to +70 °C (-4 to +158°F)
Storage humidity	0% to 95%, non-condensing
Operating humidity	10% to 90%, non-condensing
Cooling	by cooling fans, air flows from front to rear

Power

Power supply option	Built-in PSU
Supported power source	100-240V AC, 50~60Hz
Power consumption 1 - MX2-8x8-HDMI20-Audio, -L (no signal / max signal)	10 W / 75 W
Power consumption 1 - MX2-16x16-HDMI20 (no signal / max. signal)	47 W / 83 W
Power consumption 1 - MX2-24x24-HDMI20 (no signal / max. signal)	53 W / 108 W
Power consumption 1 - MX2-32x32-HDMI20-A-R (no signal / max. signal)	98 W / 167 W
Power consumption 1 - MX2-48x48-HDMI20-A-R (no signal / max. signal)	108 W / 203 W
Heat dissipation - MX2-8x8-HDMI20-Audio, -L (no signal / max signal)	34,1 BTU/h / 255,9 BTU/h
Heat dissipation - MX2-16x16-HDMI20 (no signal / max. signal)	160,3 BTU/h / 283,1 BTU/h
Heat dissipation - MX2-24x24-HDMI20 (no signal / max. signal)	180,8 BTU/h / 368,5 BTU/h
Heat dissipation - MX2-32x32-HDMI20-A-R (no signal / max. signal)	334,3 BTU/h / 569,8 BTU/h

Heat dissipation - MX2-48x48-HDMI20-A-R (no signal / max. signal)	368,5 BTU/h / 692,6 BTU/h
AC power connector	IEC C14 receptacle / Neutrik powerCON
AC fuse	F 3.15A

¹ without 500 mA current, +5V on the HDMI output

Enclosure

Rack mountable	Yes, (rack ears supplied)
Material	1 mm steel
Dimensions in mm - MX2-8x8-HDMI20-Audio	442 (482 2) W x 43.7 H x 177.5 D
Dimensions in mm - MX2-8x8-HDMI20-Audio-L	442 (482 2) W x 43.7 H x 277.4 D
Dimensions in mm - MX2-8x8-HDMI20-CA	442 (482 2) W x 43.7 H x 277.4 D
Dimensions in mm - MX2-16x16-HDMI20-Audio, -Audio-R, -R	441 (483 2) W x 132.6 H x 280.2 D
Dimensions in mm - MX2-24x24-HDMI20-Audio, -Audio-R, -R	440.5 (483 2) W x 177 H x 280.2 D
Dimensions in mm - MX2-32x32-HDMI20-A-R	440.5 (483 2) W x 355 H x 280.2 D
Dimensions in mm - MX2-48x48-HDMI20-A-R	440.5 (483 2) W x 355 H x 280.2 D
Dimensions in inch - MX2-8x8-HDMI20-Audio	17.4 (18.9 2) W x 1.7 H x 6.9 D
Dimensions in inch - MX2-8x8-HDMI20-Audio-L	17.4 (18.9 2) W x 1.7 H x 10.9 D
Dimensions in inch - MX2-8x8-HDMI20-CA	17.4 (18.9 2) W x 1.7 H x 10.9 D
Dimensions in inch - MX2-16x16-HDMI20-Audio, -Audio-R, -R	17.3 (19 2) W x 5.2 H x 11 D
Dimensions in inch - MX2-24x24-HDMI20-Audio, -Audio-R, -R	17.3 (19 2) W x 6.9 H x 11 D
Dimensions in inch - MX2-32x32-HDMI20-A-R	17.3 (19 2) W x 13.9 H x 11 D
Dimensions in inch - MX2-48x48-HDMI20-A-R	17.3 (19 2) W x 13.9 H x 11 D
Weight - MX2-8x8-HDMI20-Audio	3210 g (7 lb)
Weight - MX2-8x8-HDMI20-Audio-L	3250 g (7.1 lb)
Weight - MX2-8x8-HDMI20-CA	3210 g (7 lb)
Weight - MX2-16x16-HDMI20-R	8540 g (18.8 lb)
Weight - MX2-24x24-HDMI20	9250 g (20.4 lb)
Weight - MX2-24x24-HDMI20-Audio-R	10090 g (22.2 lb)
Weight - MX2-48x48-HDMI20-A-R	23400 g (51.6 lb)
2 with rack-mounting ears	

Video Inputs**HDMI Input**³

Connector type	19-pole HDMI type A receptacle
AV standard	DVI 1.0, HDMI 2.0
HDCP compliance	HDCP 2.2
Color space	RGB, YCbCr
Video delay	0 frame

³ Only MX2-HDMI20 series models are built with HDMI input ports.

Supported resolutions at 8 bits/color 4	up to 4096x2048@60Hz (4:4:4) or 4096x2048@60Hz (4:2:0); up to 3840x2160@60Hz (4:4:4) or 3840x2160@60Hz (4:2:0); 1920x1080@60Hz (4:4:4) up to 12 bits/color
Max. input HDMI cable length (with premium certified cable) at 1920x1080@60Hz 4:4:4.	40m
Max. input HDMI cable length (with premium certified cable) at 3840x2160@30Hz 4:4:4	15m
Max. input HDMI cable length (with premium certified cable) at 3840x2160@60Hz 4:4:4	5m
Reclocking	Pixel Accurate Reclocking
3D support	Yes
Audio formats	all formats in line with HDMI 2.0 standard; Dolby Digital, Dolby Digital Plus, Dolby TrueHD, Dolby Atmos, Dolby Vision DTS, DTS-HD Master Audio 7.1, WMA Pro
Input cable equalization	Yes, +12dB fixed

⁴ All standard VESA, CEA and other custom resolutions up to 600MHz (HDMI 2.0) are supported.

DP Input⁵

Connector type	20-pole DisplayPort receptacle
AV standard	DVI 1.0, HDMI 2.0, DP 1.2 (with 18 Gbps bandwidth limitation)
HDCP compliance	HDCP 2.2
Color space	RGB, YCbCr
Video delay	0 frame

Supported resolutions at 8 bits/color 6	up to 4096x2048@60Hz (4:4:4) or 4096x2048@60Hz (4:2:0); up to 3840x2160@60Hz (4:4:4) or 3840x2160@60Hz (4:2:0); 1920x1080@60Hz (4:4:4) up to 12 bits/color
Audio formats	all formats in line with HDMI 2.0 standard; Dolby Digital, Dolby Digital Plus, Dolby TrueHD, Dolby Atmos DTS, DTS-HD Master Audio 7.1, WMA Pro
3D support	Yes

Video Outputs**HDMI Output**

Connector type	19-pole HDMI type A receptacle
AV standard	DVI 1.0, HDMI 2.0
HDCP compliance	HDCP 2.2
Color space	RGB, YCbCr
Video delay	0 frame
Supported resolutions at 8 bits/color 6	up to 4096x2048@60Hz (4:4:4) or 4096x2048@60Hz (4:2:0); up to 3840x2160@60Hz (4:4:4) or 3840x2160@60Hz (4:2:0); 1920x1080@60Hz (4:4:4) up to 12 bits/color
Max. output HDMI cable length (with premium certified cable) at 1920x1080@60Hz 4:4:4.	40m
Max. output HDMI cable length (with premium certified cable) at 3840x2160@30Hz 4:4:4	15m
Max. output HDMI cable length (with premium certified cable) at 3840x2160@60Hz 4:4:4	5m
Reclocking	Pixel Accurate Reclocking
3D support	Yes
Audio formats	all formats in line with HDMI 2.0 standard; Dolby Digital, Dolby Digital Plus, Dolby TrueHD, Dolby Atmos, Dolby Vision DTS, DTS-HD Master Audio 7.1, WMA Pro
Input cable equalization	Yes, +12dB fixed

⁵ Only MX2-DH series models are built with HDMI input ports.

⁶ All standard VESA, CEA and other custom resolutions up to 600MHz (HDMI 2.0 / DP 1.2) are supported.

DP Output ⁷

Connector type	20-pole DisplayPort receptacle
AV standard	DVI 1.0, HDMI 2.0, DP 1.2 (with 18 Gbps bandwidth limitation)
HDCP compliance	HDCP 2.2
Color space	RGB, YCbCr
Video delay	0 frame
Supported resolutions at 8 bits/color ⁸	up to 4096x2048@60Hz (4:4:4) or 4096x2048@60Hz (4:2:0); up to 3840x2160@60Hz (4:4:4) or 3840x2160@60Hz (4:2:0); 1920x1080@60Hz (4:4:4) up to 12 bits/color
Audio formats	2-channel LPCM (48-192kHz)
3D support	Yes

⁷ Only MX2-DH series models are built with HDMI input ports.

⁸ All standard VESA, CEA and other custom resolutions up to 600MHz (DP 1.2) are supported.

Audio Ports**Analog Audio Input** ⁹

Connector type	5-pole Phoenix connector
Audio formats	2-channel PCM
Sampling frequency	48 kHz
Maximum input level	+0 dBu, 0.77 Vrms, 2.19 Vpp
Signal transmission	Balanced / unbalanced audio
Balance	-100 (-95 dB) - +100 (0 dB) (0 = center)
Gain	-12 dB - +35 dB

Analog Audio Output ¹⁰

Connector type	5-pole Phoenix connector
Audio formats	2-channel PCM
Sampling frequency	48 kHz
Signal transmission	Balanced / unbalanced audio
Volume	-78 dB - 0 dB
Balance	-100 (-95 dB) - +100 (0 dB) (0 = center)
Nominal Differential Output Level @ 0 dB Gain	+4 dBu
Nominal Differential Output Level @ 3 dB Gain	+7 dBu

⁹ Only -Audio and -A suffixed models are built with analog audio input ports. See more details in the [Model Comparison](#) section.

¹⁰ Only -Audio and -A suffixed models are built with analog audio input ports. See more details in the [Model Comparison](#) section.

Control Ports**RS-232 serial port**

Connector type (-R suffixed models)	9-pole D-SUB
Connector type (in other models)	3-pole Phoenix connector
Baud rates	Between 200 and 115200 Baud
Data bits	8 or 9
Parity	None / Odd / Even
Stop bits	1 / 1.5 / 2

Ethernet port

Connector type (-R suffixed models)	RJ45 female
Connector type (in other models)	Neutrik etherCON
Ethernet data rate	10/100Base-T, full duplex with autodetect
Power over Ethernet (PoE)	Not supported

USB port

Connector type	USB mini-B type
USB compliance	USB 2.0
Device class	HID

EDID Management

EDID emulation	Yes
EDID memory	144 factory presets, 100 user-programmable

13.2. Applied Ports (Network Settings)

The following ports are necessary to pass via a network switch/firewall for a proper working between the device and the softwares:

Purpose/function	Affected software	Protocol	Port nr.
Firmware update SCP	LDU2	TCP	22
Device Discovery	LDC	UDP	224.0.0.251:5353
Remote IP	LDC	UDP	230.76.87.82:37421
LW2 protocol	-	TCP	10001
LW3 protocol	-	TCP	6107
Secondary protocol	-	TCP	23
HTTP port	-	TCP	80

13.3. Factory Default Settings

Parameter	Setting / Value
Network Settings	
IP address	Dynamic (DHCP is enabled)
RS-232 Port	
Port setting	57600 BAUD, 8, N, 1
Control protocol	LW3 protocol
General Video Settings	
Crosspoint setting	Input 1 on all outputs
Emulated EDID	F49 - (Universal HDMI, all audio formats with deep color support) on all inputs
HDMI port	
HDCP enable (input)	Allow HDCP 2.2 and HDCP 1.4
Audio source (input)	HDMI
HDCP (output)	Depends on input
Signal type (output)	Auto
Conversion mode (output)	Passthrough
Audio mode: HDMI port (output)	HDMI
Audio mode: HDMI with analog audio (output)	HDMI+ANALOG
Scrambling	Auto
TMDS clock rate	Auto
Signal type	Auto
DisplayPort	
HDCP enable (input)	Allow HDCP 2.2 and HDCP 1.4
Link data rate (input)	Max. HBR2 (5.4 Gbps)
Link lane count (input)	Max. 4 lane
Audio source (input)	DisplayPort
Audio Input/Output Ports	
Audio source	HDMI
Audio mode (HDMI out)	HDMI
Audio mode (Analog audio out)	HDMI+ANALOG
Analog audio output	Enabled (de-embedding from HDMI signal)
Analog Audio Input Levels	Balance: 0 (center) Gain: 0 dB
Analog Audio Output Levels	Balance: 0 (center) Volume: 0 dB

13.4. Mechanical Drawings

MX2-8x8-HDMI20-Audio

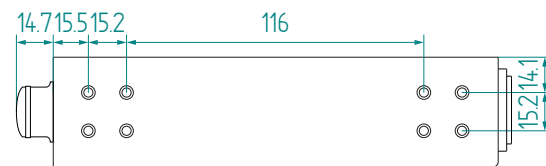
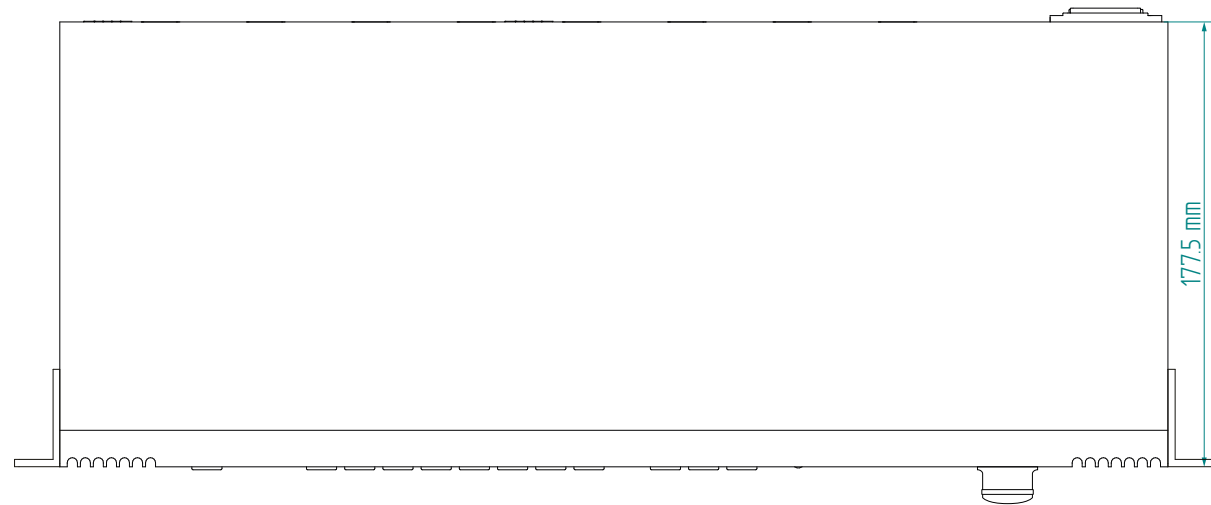
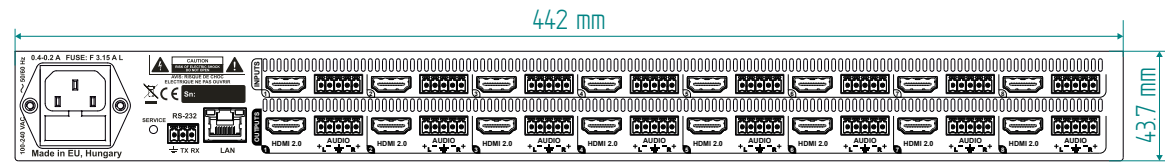
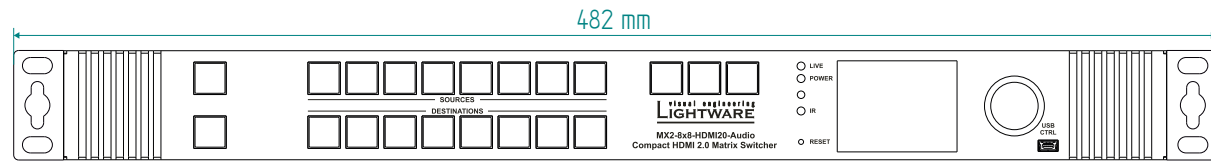

MX2-8x8-HDMI20-Audio-L

INFO: MX2-4x4-HDMI20-CA, MX2-8x4-HDMI20-CA, MX2-8x8-HDMI20-L, -CA, MX2-8x8-DH-4DPi-A; MX2-8x8-DH-8DPi-A models have the same size.

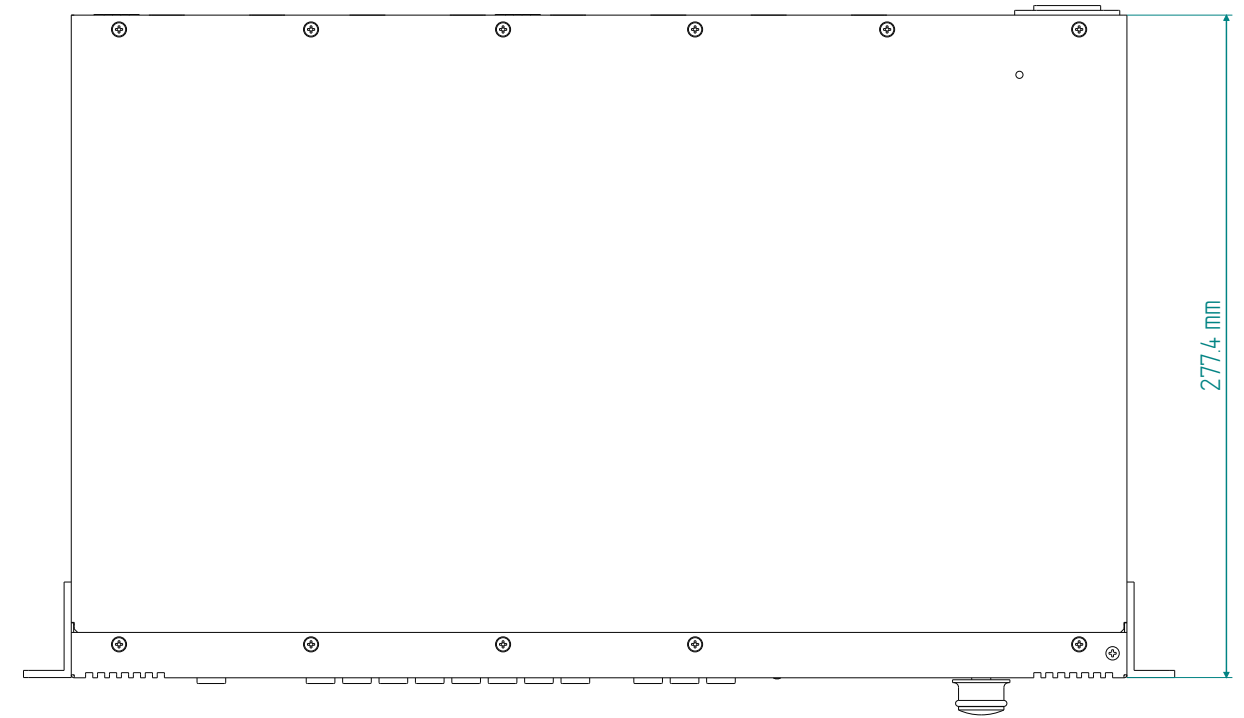
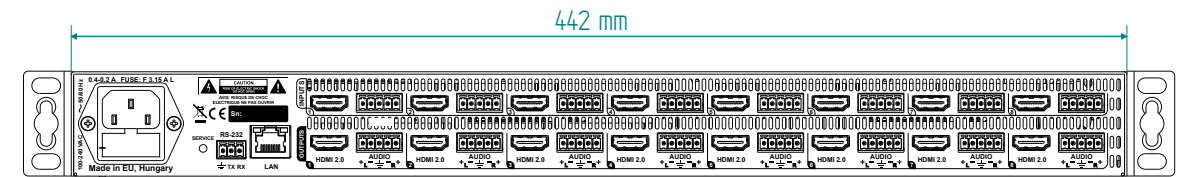
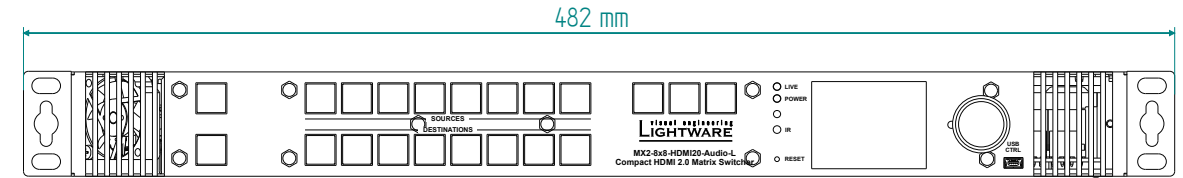

MX2-16x16-HDMI20-Audio-R

INFO: The 2 RU-high models have the same size: MX2-16x8-HDMI20-Audio-R, MX2-16x16-HDMI20, -R, -Audio, -Audio-R; MX2-16x16-DH-8DPi-A-R; MX2-16x16-DH-16DPi-R

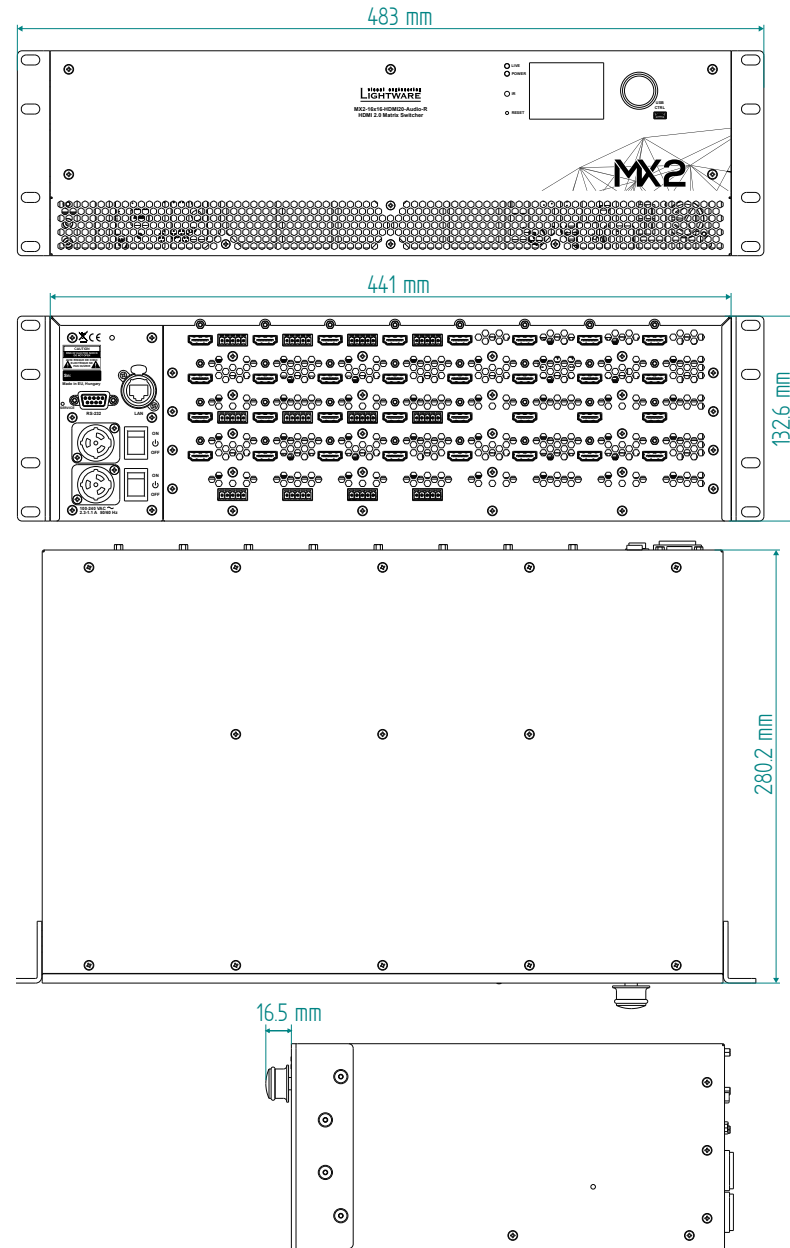

MX2-24x24-HDMI20-Audio-R

INFO: The 4 RU-high models have the same size: MX2-24x24-HDMI20, -R, -Audio, -Audio-R; MX2-24x24-DH-12DPi-R; -A-R

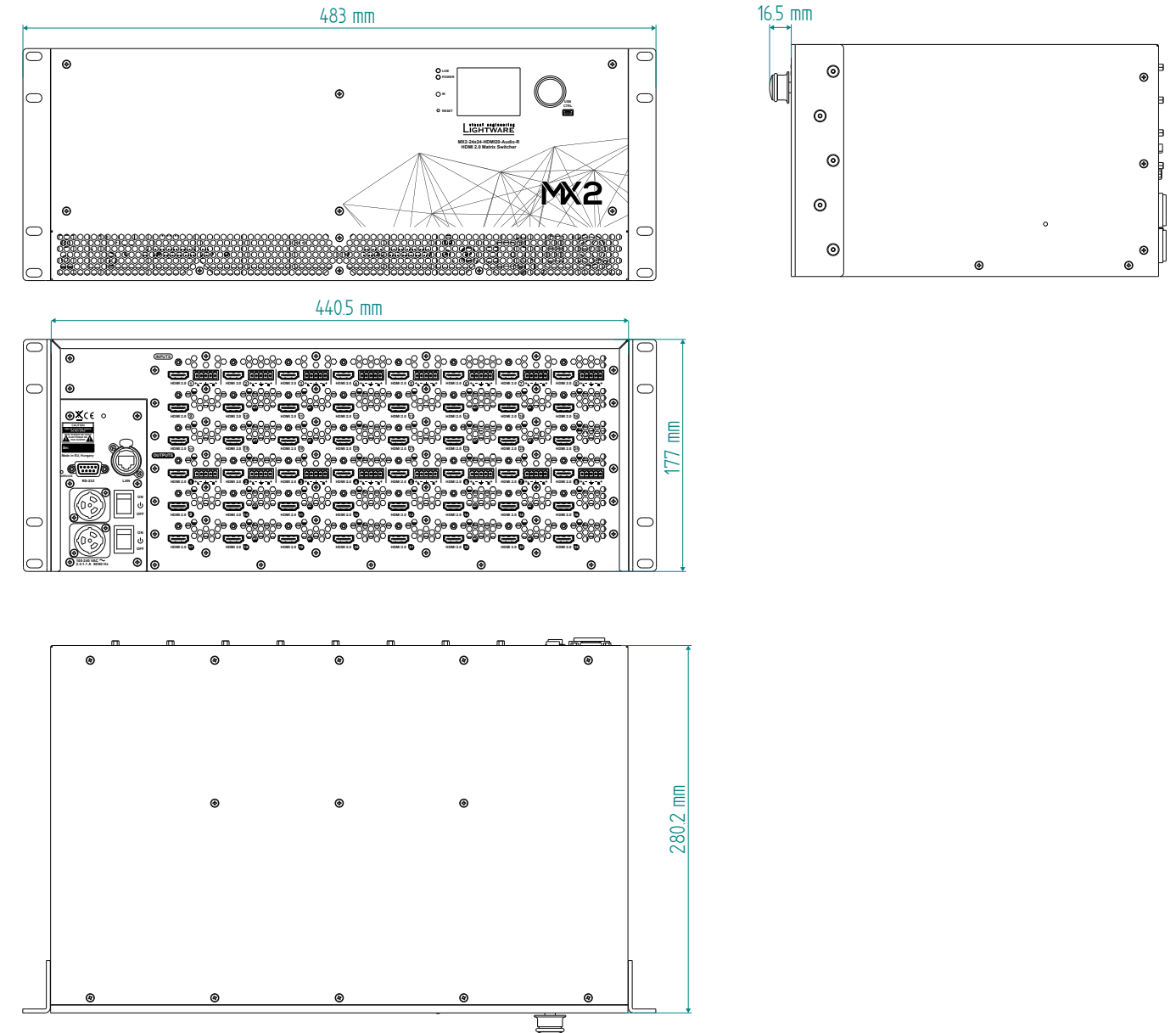

MX2-48x48-HDMI20-A-R

INFO: The 8 RU-high models have the same size: MX2-32x32-HDMI20-A-R, MX2-32x32-DH-16DPi-A-R, MX2-48x48-HDMI20-A-R.

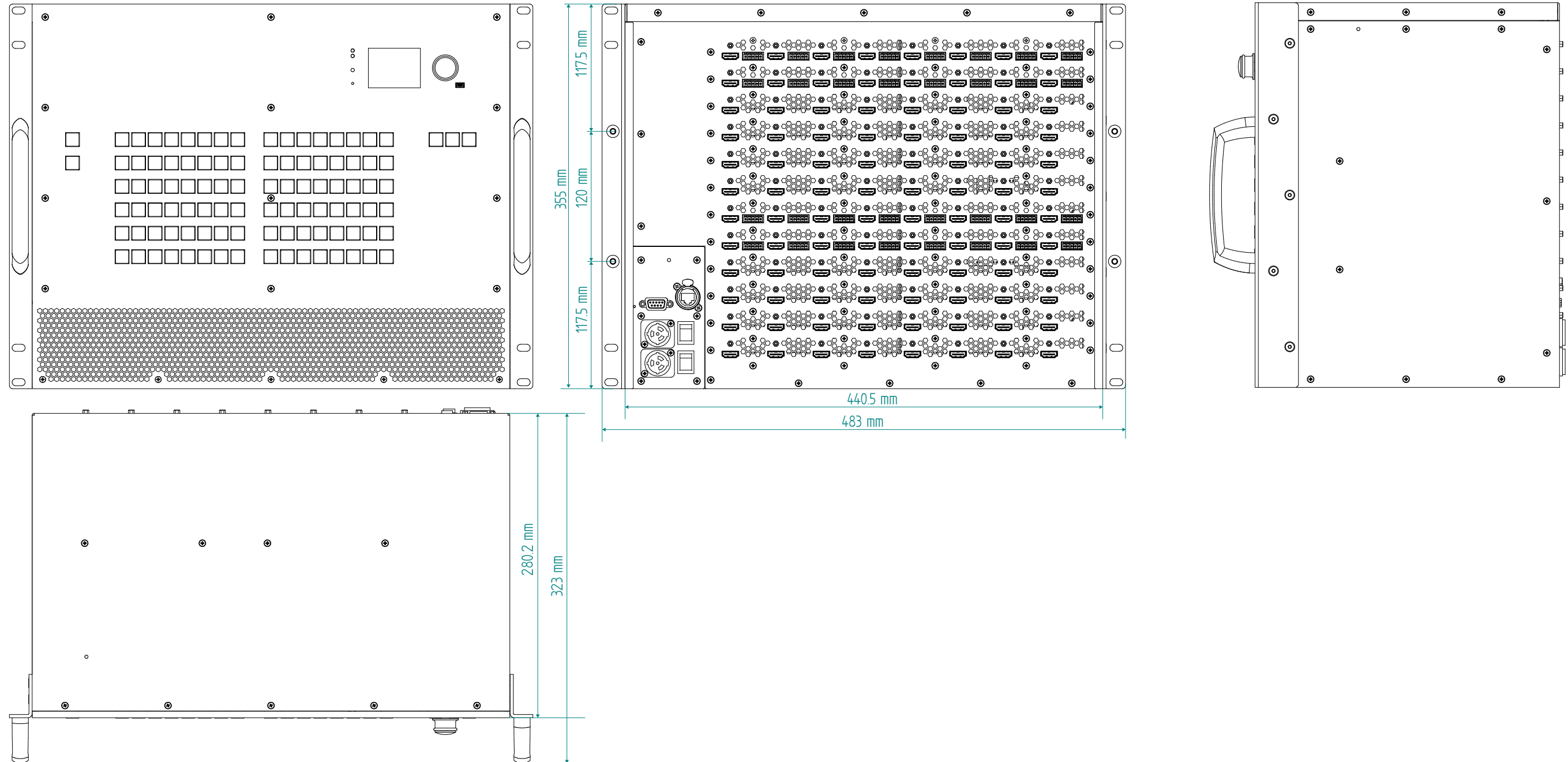

13.5. Cable Wiring Guide

Inputs and outputs of audio devices are symmetric or asymmetric. The main advantage of the symmetric lines is the better protection against the noise, therefore they are widely used in the professional audio industry. Symmetric audio is most often referred to as balanced audio, as opposed to asymmetric, which is referred to as unbalanced audio. Lighthouse products are usually built with 5-pole Phoenix connectors so we would like to help users assembling their own audio cables. See the most common cases below.

ATTENTION! Symmetric and asymmetric lines can be linked with passive accessories (e.g. special cables), but in this case half of the line level is lost.

ATTENTION! There are numerous types of regularly used connector and cable types to connect audio devices. Please always make sure that a connector or cable fits your system before use.

ATTENTION! Never join the phase-inverted (negative, cold or -) poles (either right and left) to the ground or to each other on the output side, as this can damage the unit.

INFO: Use a galvanic isolation in case of a ground loop.

13.5.1. Serial Ports

The device is built with 3-pole Phoenix connector. See the examples below of connecting to a DCE (Data Circuit-terminating Equipment) or a DTE (Data Terminal Equipment) type device:

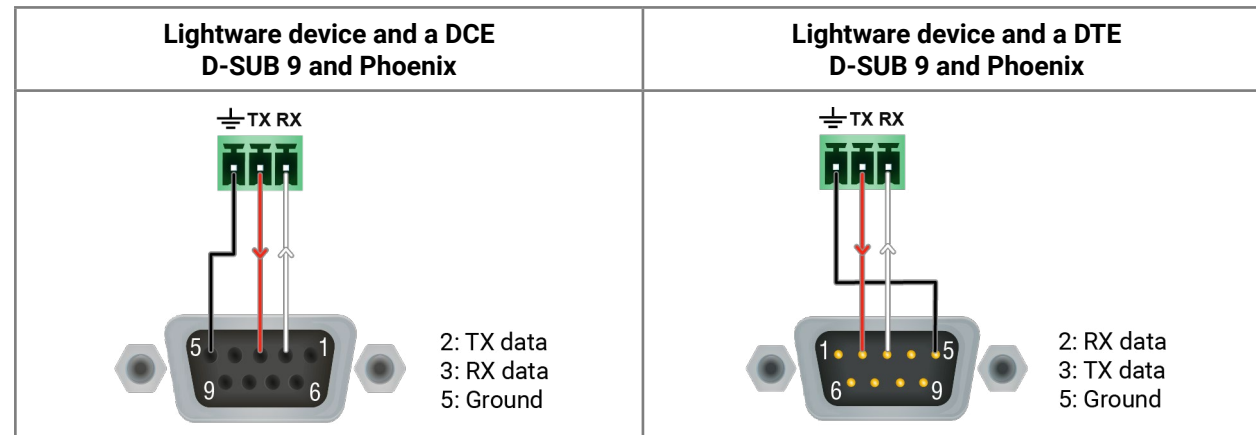

13.5.2. Audio Ports

The Pinout of the 5-pole Phoenix Connector



Pin nr.	Signal
1	Left+
2	Left-
3	Ground
4	Right-
5	Right+

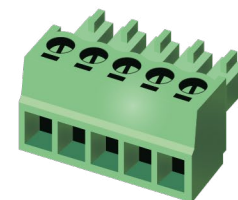

From Unbalanced Output to Balanced Input

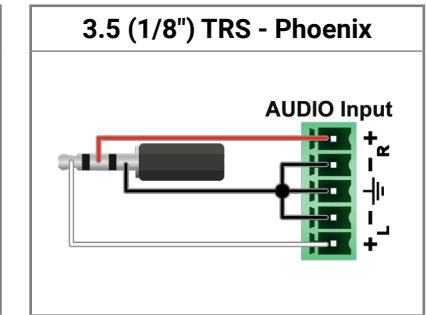
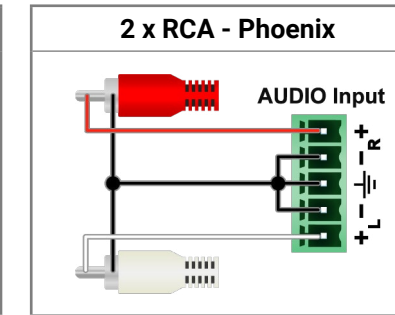
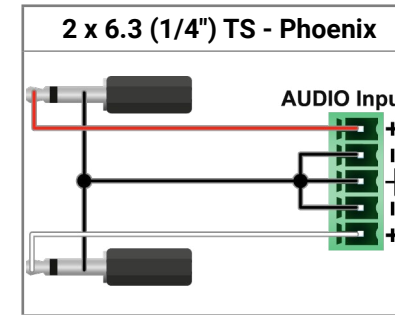

From Balanced Output to Unbalanced Input

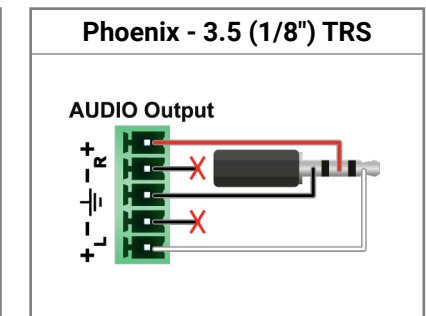
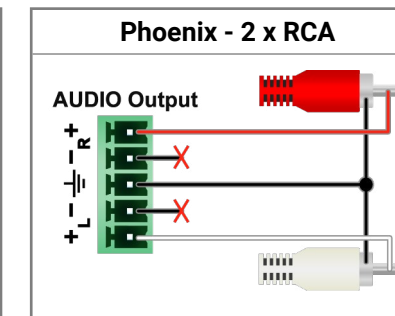
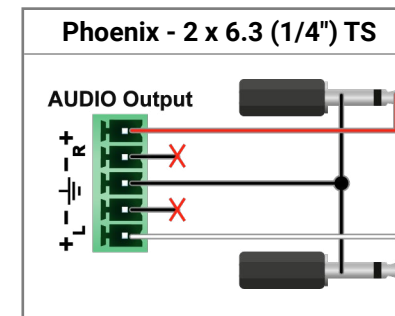

From Balanced Output to Balanced Input

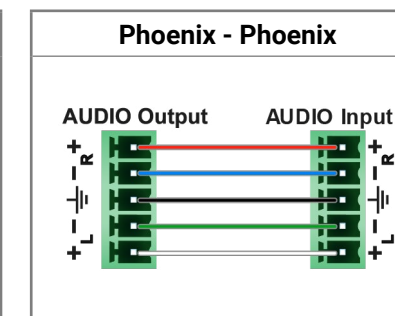
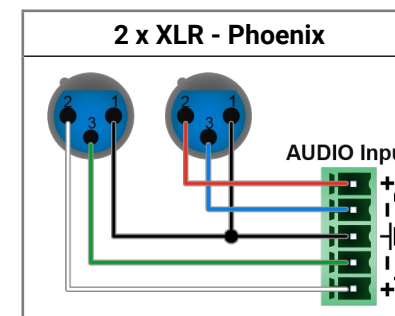
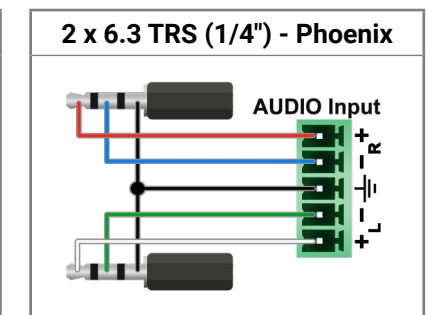
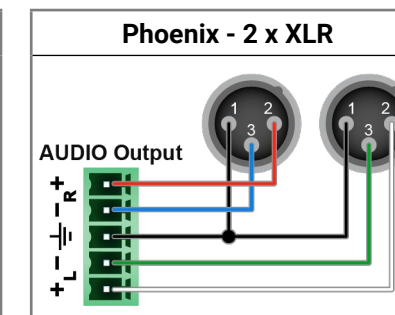
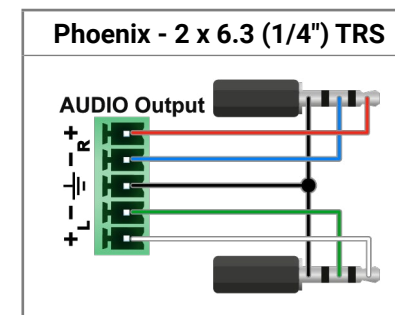

13.6. Factory EDID List

Mem.	Resolution		Type
F1	640 x	480 @ 60.00 Hz	D
F2	848 x	480 @ 60.00 Hz	D
F3	800 x	600 @ 60.32 Hz	D
F4	1024 x	768 @ 60.00 Hz	D
F5	1280 x	768 @ 50.00 Hz	D
F6	1280 x	768 @ 59.94 Hz	D
F7	1280 x	768 @ 75.00 Hz	D
F8	1360 x	768 @ 60.02 Hz	D
F9	1280 x	1024 @ 50.00 Hz	D
F10	1280 x	1024 @ 60.02 Hz	D
F11	1280 x	1024 @ 75.02 Hz	D
F12	1400 x	1050 @ 50.00 Hz	D
F13	1400 x	1050 @ 60.00 Hz	D
F14	1400 x	1050 @ 75.00 Hz	D
F15	1680 x	1050 @ 60.00 Hz	D
F16	1920 x	1080 @ 50.00 Hz	D
F17	1920 x	1080 @ 60.00 Hz	D
F18	2048 x	1080 @ 50.00 Hz	D
F19	2048 x	1080 @ 60.00 Hz	D
F20	1600 x	1200 @ 50.00 Hz	D
F21	1600 x	1200 @ 60.00 Hz	D
F22	1920 x	1200 @ 50.00 Hz	D
F23	1920 x	1200 @ 59.56 Hz	D
F24	2048 x	1200 @ 59.96 Hz	D
F29	Universal DVI		
F30	1440 x	480 @ 60.05 Hz	H
F31	1440 x	576 @ 50.08 Hz	H
F32	640 x	480 @ 59.95 Hz	H
F33	720 x	480 @ 59.94 Hz	H

Mem.	Resolution		Type
F34	720 x	576 @ 50.00 Hz	H
F35	1280 x	720 @ 50.00 Hz	H
F36	1280 x	720 @ 60.00 Hz	H
F37	1920 x	1080 @ 50.04 Hz	H
F38	1920 x	1080 @ 50.00 Hz	H
F39	1920 x	1080 @ 60.05 Hz	H
F40	1920 x	1080 @ 60.05 Hz	H
F41	1920 x	1080 @ 24.00 Hz	H
F42	1920 x	1080 @ 25.00 Hz	H
F43	1920 x	1080 @ 30.00 Hz	H
F44	1920 x	1080 @ 50.00 Hz	H
F45	1920 x	1080 @ 60.00 Hz	H
F46	1920 x	1080 @ 60.00 Hz	H
F47	Universal HDMI with PCM audio		
F48	Universal HDMI with All audio		
F49	Universal HDMI, all audio, deep color		
F91	1024 x	2400 @ 60.01 Hz	H
F98	1280 x	720 @ 60.00 Hz	H
F99	1920 x	1080 @ 60.00 Hz	H
F100	1024 x	768 @ 60.00 Hz	H
F101	1280 x	1024 @ 50.00 Hz	H
F102	1280 x	1024 @ 60.02 Hz	H
F103	1280 x	1024 @ 75.02 Hz	H
F104	1600 x	1200 @ 50.00 Hz	H
F105	1600 x	1200 @ 60.00 Hz	H
F106	1920 x	1200 @ 59.56 Hz	H
F107	2560 x	1440 @ 59.95 Hz	H
F108	2560 x	1600 @ 59.86 Hz	H
F109	3840 x	2400 @ 24.00 Hz	H

Mem.	Resolution		Type
F110	3840 x	2160 @ 24.00 Hz	H
F111	3840 x	2160 @ 25.00 Hz	H
F112	3840 x	2160 @ 30.00 Hz	H
F118	Universal HDMI, 4K, PCM audio		
F119	Universal HDMI, 4K, all audio		
F120	3840 x	2160 @ 60.00 Hz	H
F121	1440 x	1080 @ 59.91 Hz	H
F122	2560 x	2048 @ 59.98 Hz	H
F123	1280 x	800 @ 59.91 Hz	H
F124	1440 x	900 @ 59.90 Hz	H
F125	1366 x	768 @ 60.00 Hz	H
F126	1600 x	900 @ 59.98 Hz	H
F127	2048 x	1080 @ 60.00 Hz	H
F128	2560 x	1080 @ 60.00 Hz	H
F129	3440 x	1440 @ 24.99 Hz	H
F130	3440 x	1440 @ 29.99 Hz	H
F131	4096 x	2160 @ 25.00 Hz	H
F132	4096 x	2160 @ 30.00 Hz	H
F133	4096 x	2160 @ 60.00 Hz	4:2:0
F134	3440 x	1440 @ 23.99 Hz	H
F135	4096 x	2160 @ 24.00 Hz	H
F136	3840 x	2400 @ 29.99 Hz	H
F137	3840 x	2160 @ 60.00 Hz	H2
F138	3840 x	2160 @ 50.00 Hz	H2
F139	Universal HDMI 2.0, UHD, PCM audio		
F140	Universal HDMI 2.0, UHD, all audio		
F141	4096 x	2160 @ 60.00 Hz	4:4:4
F142	4096 x	2160 @ 50.00 Hz	4:4:4
F143	Universal HDMI 2.0, 4K, PCM audio		

Mem.	Resolution		Type
F144	Universal HDMI 2.0, 4K, all audio		
F146	3840 x	2160 @ 60.00 Hz	HDR
F147	3840 x	2160 @ 60.00 Hz	RB, PCM
F148	3840 x	2160 @ 60.00 Hz	RB, ALL
F150	5120 x	1440p @ 29.97 Hz	H
F151	5120 x	2160p @ 29.97 Hz	H
F152	5120 x	2880p @ 29.97 Hz	H
F153	7680 x	1080p @ 59.94 Hz	H

Legend

- D: DVI EDID
- H: HDMI EDID
- U: Universal EDID (supporting many common EDIDs)
- 4:2:0 :EDID with chroma color subsampling
- 4:4:4 :EDID without color subsampling
- H2: HDMI2.0-compatible EDID
- HDR: EDID with High Dynamic Range mode support
- RB: Reduced blanking interval
- PCM: With PCM audio support
- ALL: All type of audio support (within the HDMI standard)

DI

Please note that minor changes in the factory EDID list may be applied in further firmware versions.

13.7. Front and Rear Views with Port Numbering

13.7.1. MX2-4x4-HDMI20-CA

HDMI Input port nr.	HDMI Output port nr.	DP Input port nr.	DP Output port nr.	Audio Input port nr.	Audio Output port nr.
1-4	1-4	-	-	-	1-2

13.7.2. MX2-8x4-HDMI20-CA

HDMI Input port nr.	HDMI Output port nr.	DP Input port nr.	DP Output port nr.	Audio Input port nr.	Audio Output port nr.
1-8	1-4	-	-	1-2	1-2

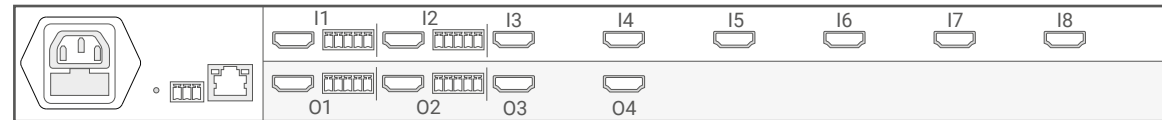

13.7.3. MX2-8x8-HDMI20-L

HDMI Input port nr.	HDMI Output port nr.	DP Input port nr.	DP Output port nr.	Audio Input port nr.	Audio Output port nr.
1-8	1-8	-	-	-	-

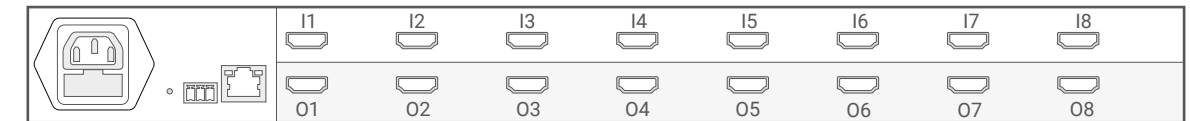
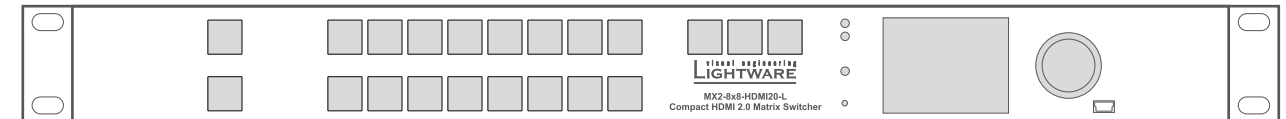

13.7.4. MX2-8x8-HDMI20-CA

HDMI Input port nr.	HDMI Output port nr.	DP Input port nr.	DP Output port nr.	Audio Input port nr.	Audio Output port nr.
1-8	1-8	-	-	1-2	1-2

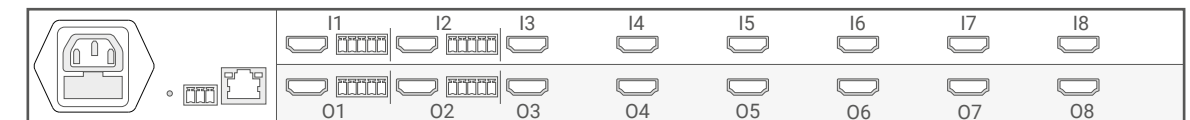

13.7.5. MX2-8X8-HDMI20-Audio

HDMI Input port nr.	HDMI Output port nr.	DP Input port nr.	DP Output port nr.	Audio Input port nr.	Audio Output port nr.
1-8	1-8	-	-	1-8	1-8

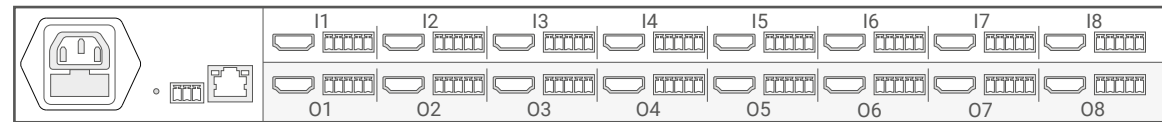
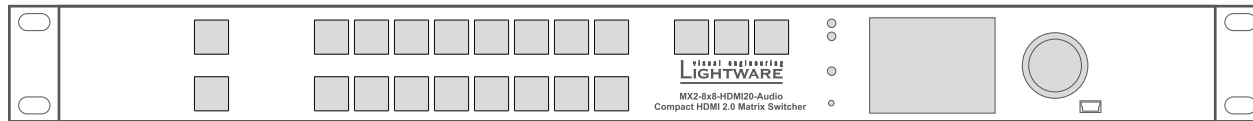

13.7.6. MX2-8X8-HDMI20-Audio-L

HDMI Input port nr.	HDMI Output port nr.	DP Input port nr.	DP Output port nr.	Audio Input port nr.	Audio Output port nr.
1-8	1-8	-	-	1-8	1-8

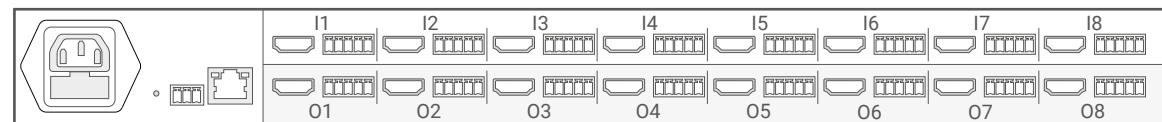
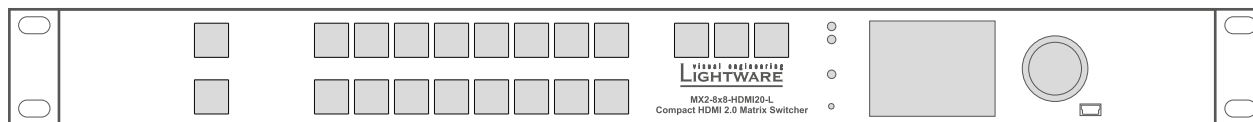

13.7.7. MX2-8x8-DH-4DPi-A

HDMI Input port nr.	HDMI Output port nr.	DP Input port nr.	DP Output port nr.	Audio Input port nr.	Audio Output port nr.
5-8	1-8	1-4	-	-	1-2

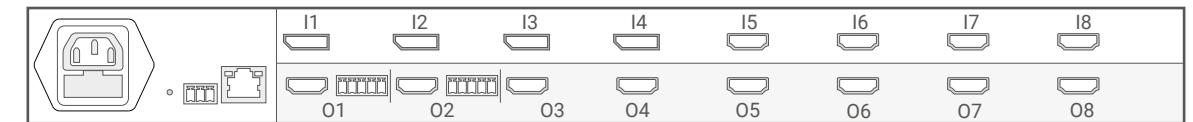
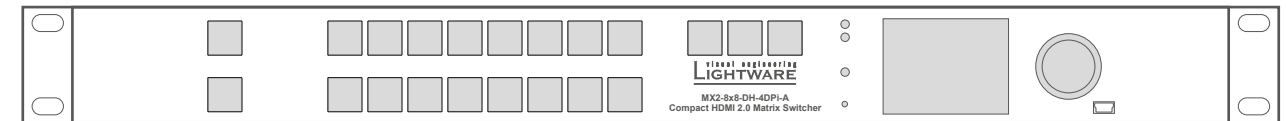

13.7.8. MX2-8x8-DH-4DPio-A

HDMI Input port nr.	HDMI Output port nr.	DP Input port nr.	DP Output port nr.	Audio Input port nr.	Audio Output port nr.
1-4	1-4	5-8	5-8	1-8	1-8

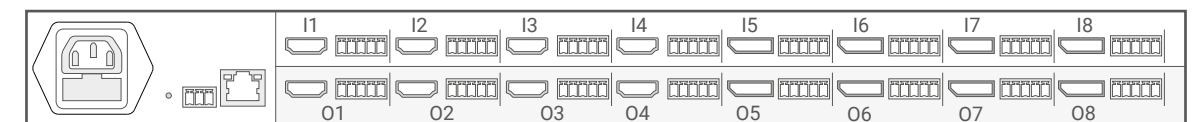
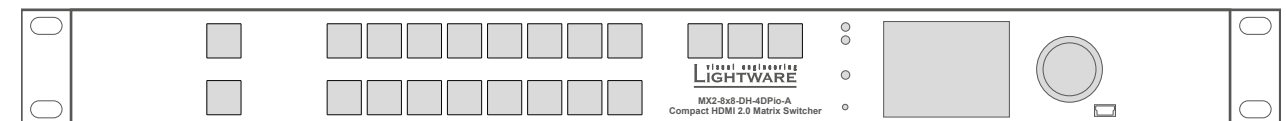

13.7.9. MX2-8x8-DH-8DPi-A

HDMI Input port nr.	HDMI Output port nr.	DP Input port nr.	DP Output port nr.	Audio Input port nr.	Audio Output port nr.
-	1-8	1-8	-	1-4	1-4

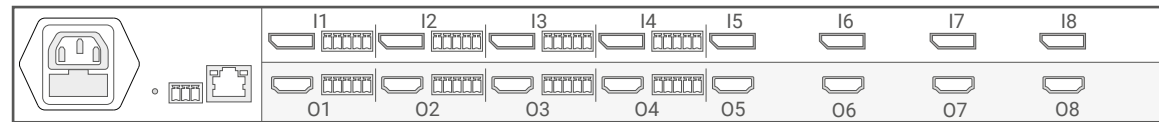
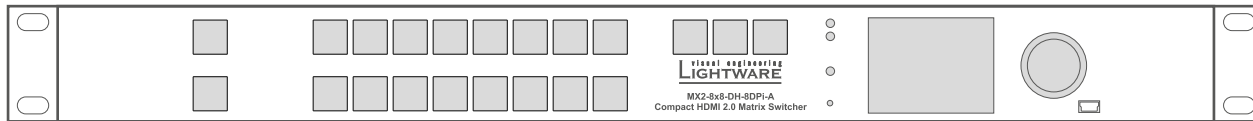

13.7.10. MX2-8x8-DH-8DPio-A

HDMI Input port nr.	HDMI Output port nr.	DP Input port nr.	DP Output port nr.	Audio Input port nr.	Audio Output port nr.
-	-	1-8	1-8	1-4	1-8

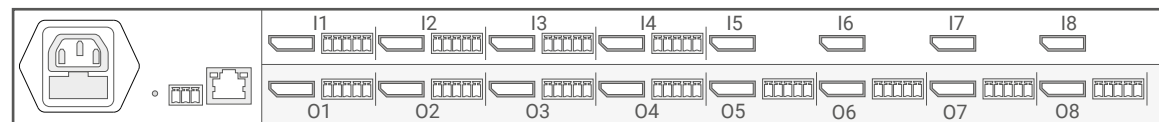
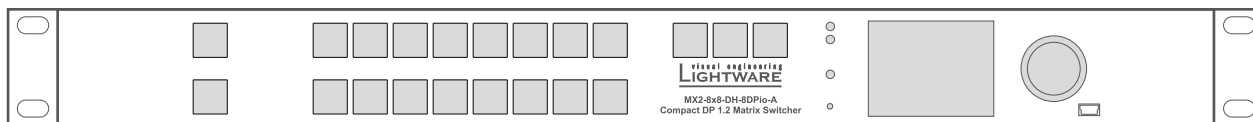

13.7.11. MX2-16x8-HDMI20-Audio-R

HDMI Input port nr.	HDMI Output port nr.	DP Input port nr.	DP Output port nr.	Audio Input port nr.	Audio Output port nr.
1-16	1-8	-	-	1-4	1-4, 9-12

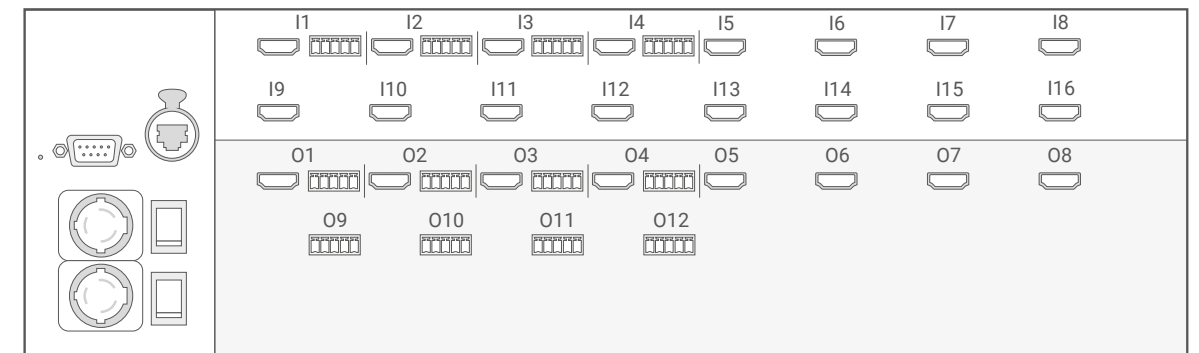

13.7.12. MX2-16x16-HDMI20

HDMI Input port nr.	HDMI Output port nr.	DP Input port nr.	DP Output port nr.	Audio Input port nr.	Audio Output port nr.
1-16	1-6	-	-	-	-

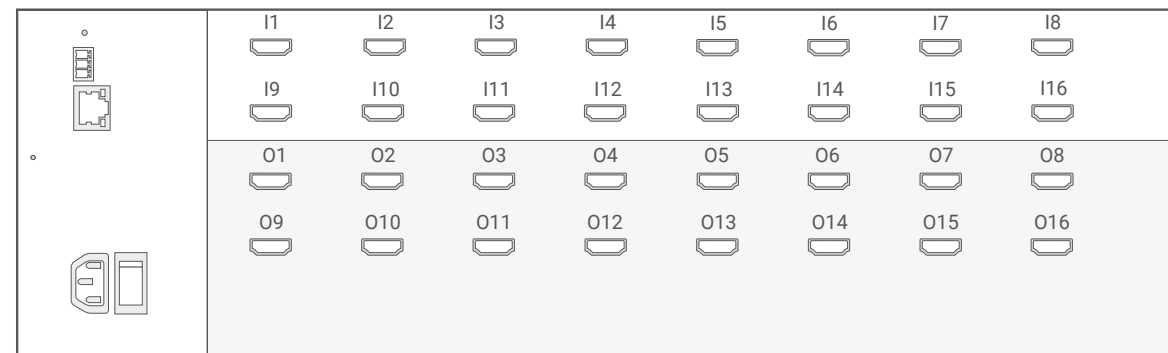
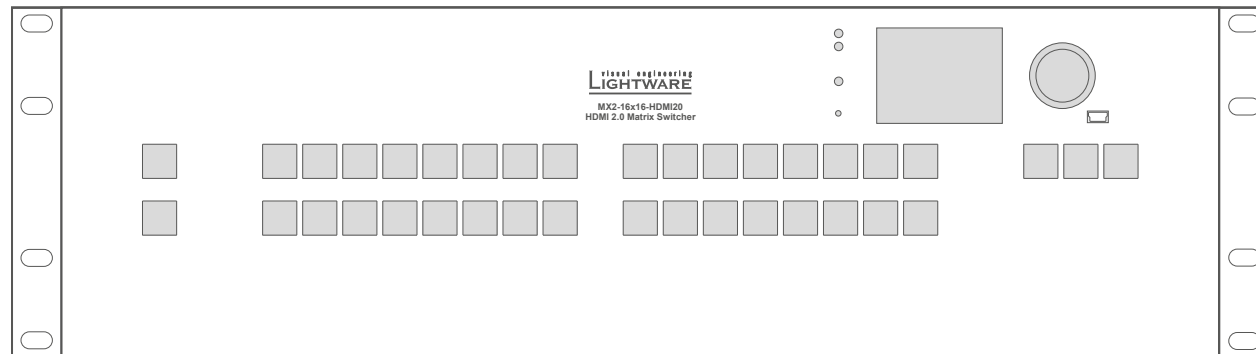

13.7.13. MX2-16x16-HDMI20-Audio

HDMI Input port nr.	HDMI Output port nr.	DP Input port nr.	DP Output port nr.	Audio Input port nr.	Audio Output port nr.
1-16	1-6	-	-	1-4	1-4; 17-20

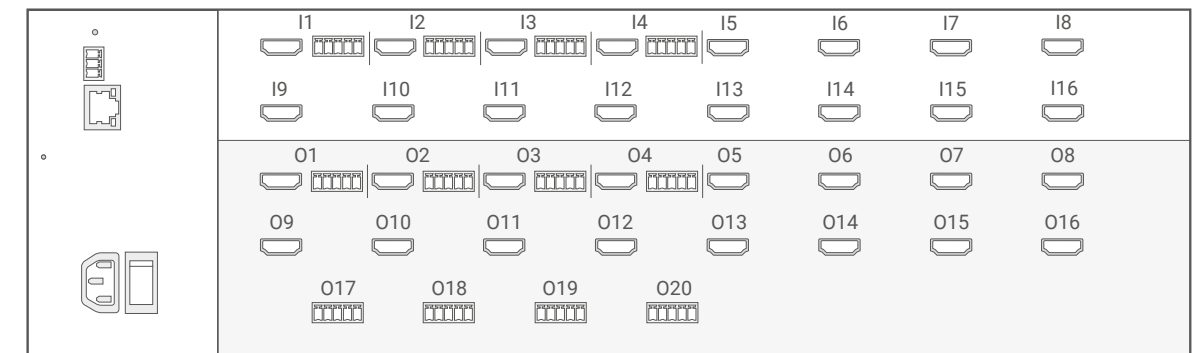

13.7.14. MX2-16x16-HDMI20-R

HDMI Input port nr.	HDMI Output port nr.	DP Input port nr.	DP Output port nr.	Audio Input port nr.	Audio Output port nr.
1-16	1-16	-	-	-	-

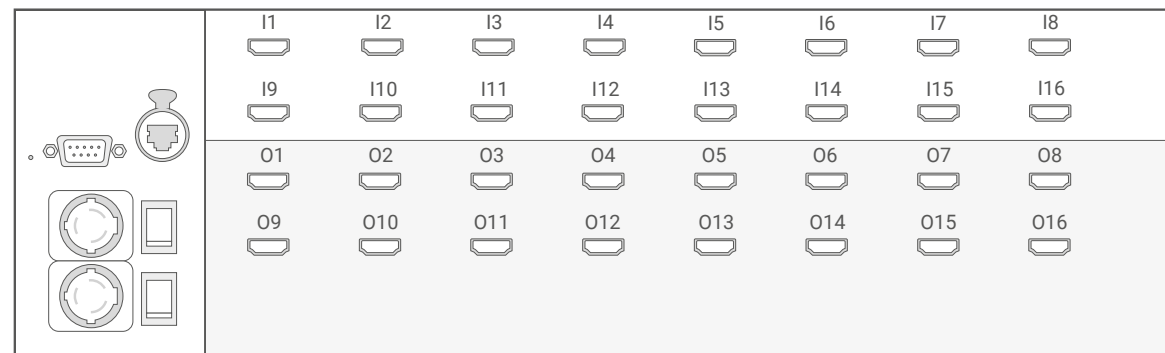
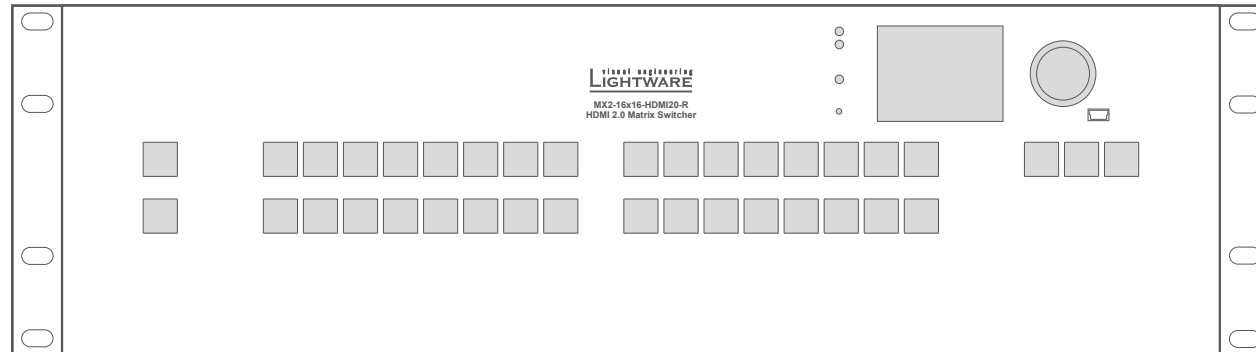

13.7.15. MX2-16x16-HDMI20-Audio-R

HDMI Input port nr.	HDMI Output port nr.	DP Input port nr.	DP Output port nr.	Audio Input port nr.	Audio Output port nr.
1-16	1-16	-	-	1-4	1-4; 17-20

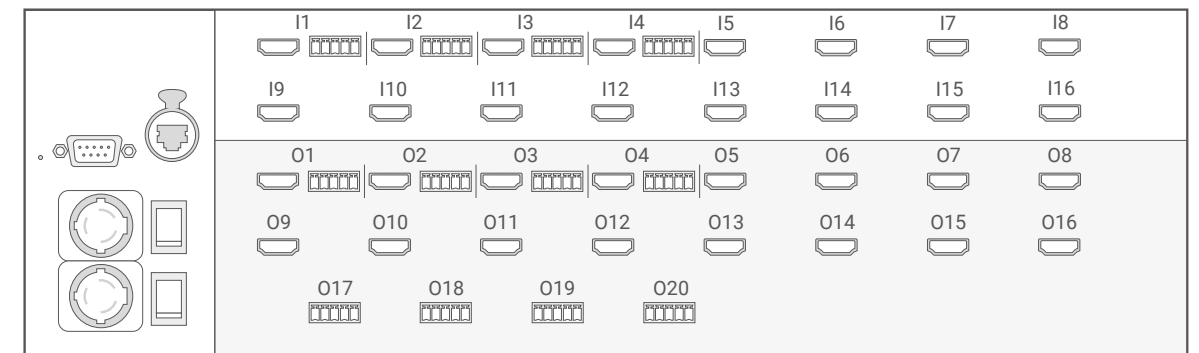
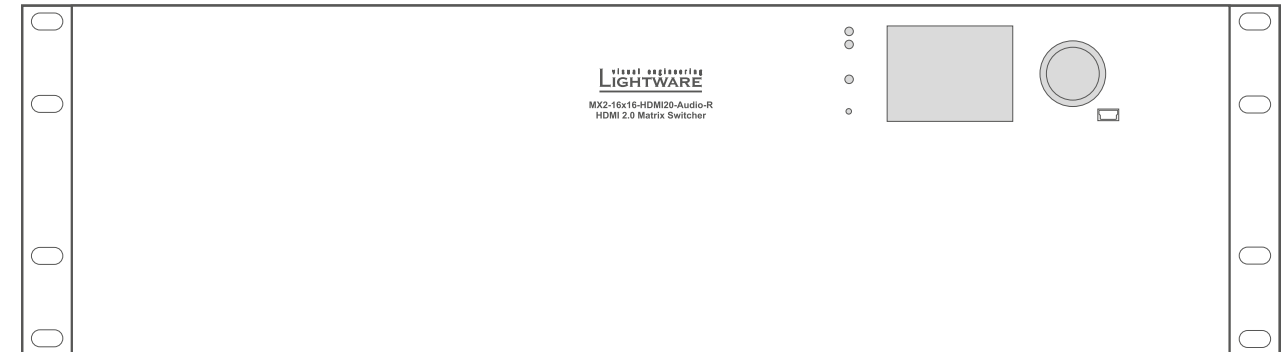

13.7.16. MX2-16x16-DH-8DPi-A-R

HDMI Input port nr.	HDMI Output port nr.	DP Input port nr.	DP Output port nr.	Audio Input port nr.	Audio Output port nr.
9-16	1-16	1-8	-	9-16	1-4; 17-20

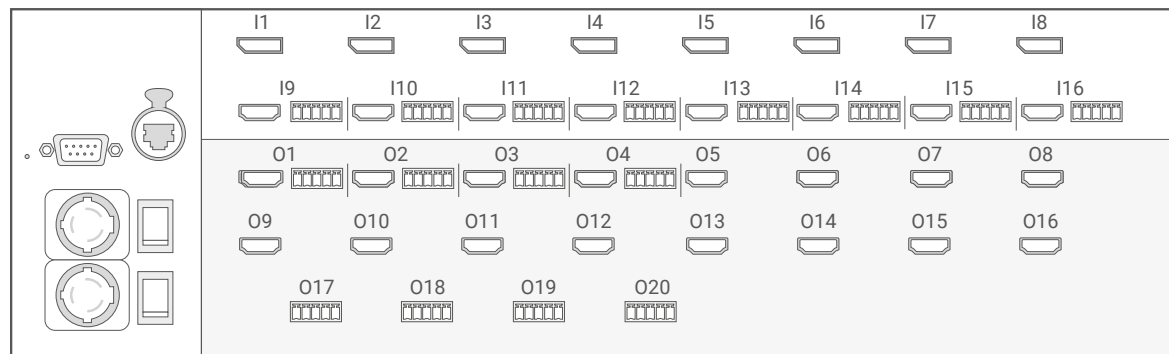
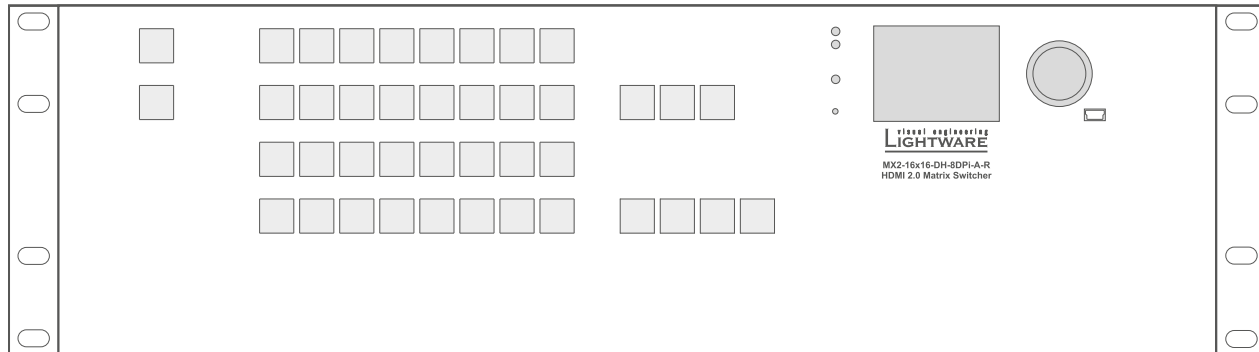

13.7.17. MX2-16x16-DH-16DPi-R

HDMI Input port nr.	HDMI Output port nr.	DP Input port nr.	DP Output port nr.	Audio Input port nr.	Audio Output port nr.
-	1-16	1-16	-	-	-

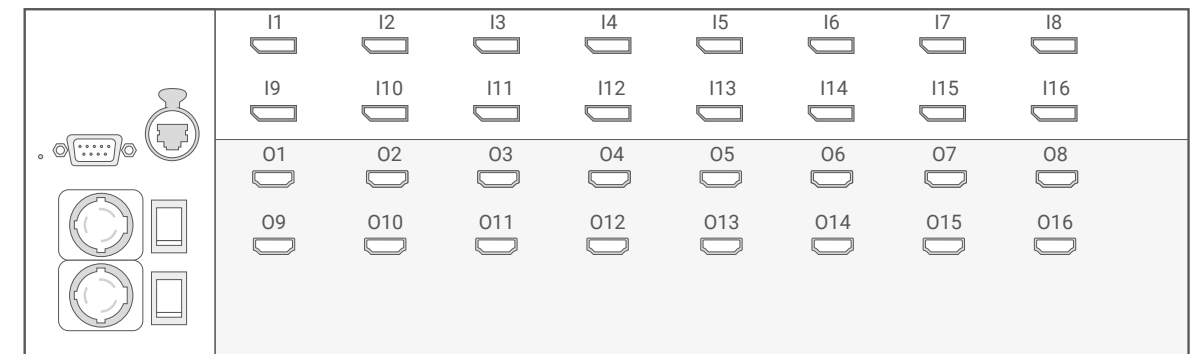
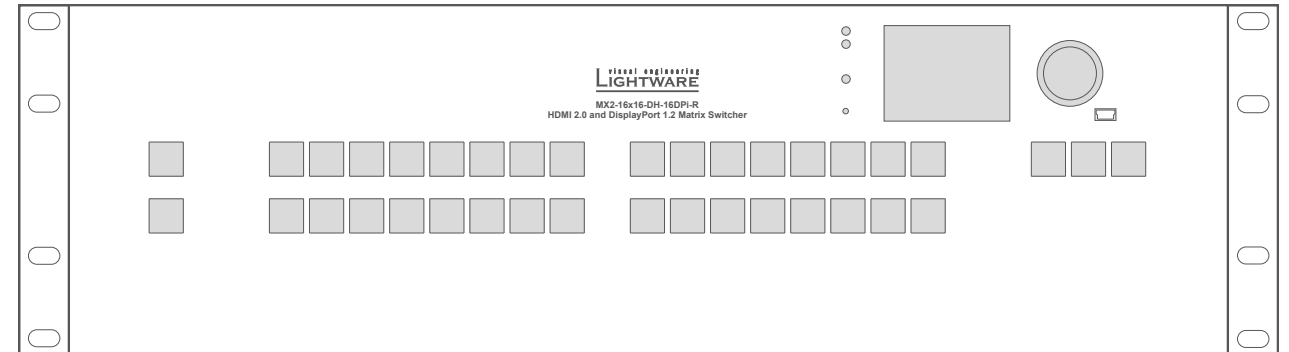

13.7.18. MX2-24x24-HDMI20

HDMI Input port nr.	HDMI Output port nr.	DP Input port nr.	DP Output port nr.	Audio Input port nr.	Audio Output port nr.
1-24	1-24	-	-	-	-

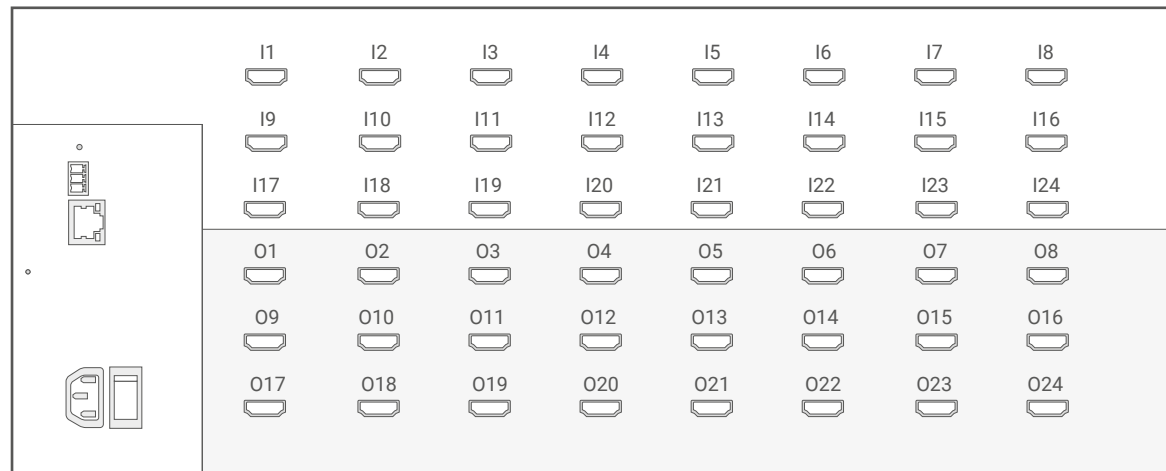
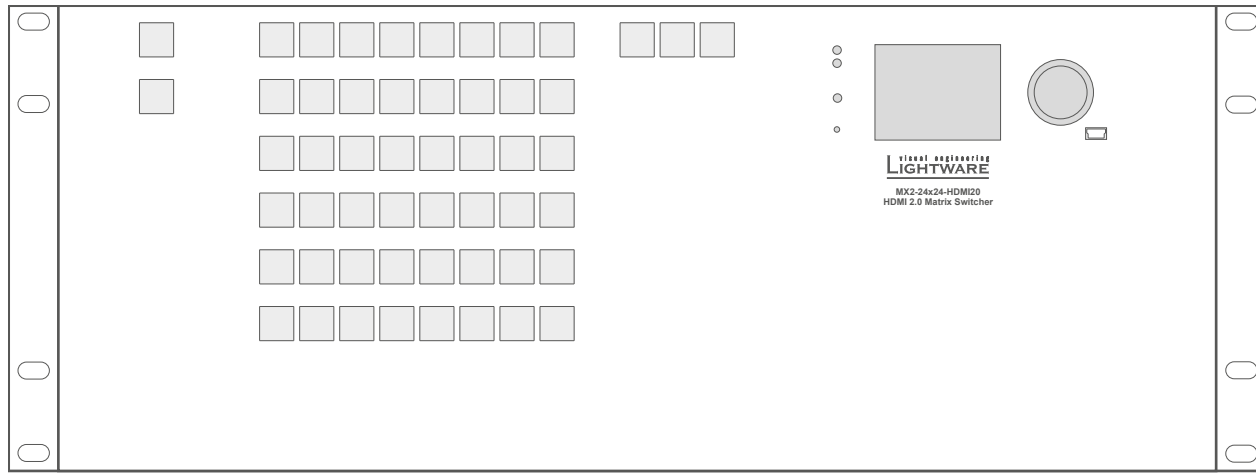

13.7.19. MX2-24x24-HDMI20-Audio

HDMI Input port nr.	HDMI Output port nr.	DP Input port nr.	DP Output port nr.	Audio Input port nr.	Audio Output port nr.
1-24	1-24	-	-	1-8	1-8

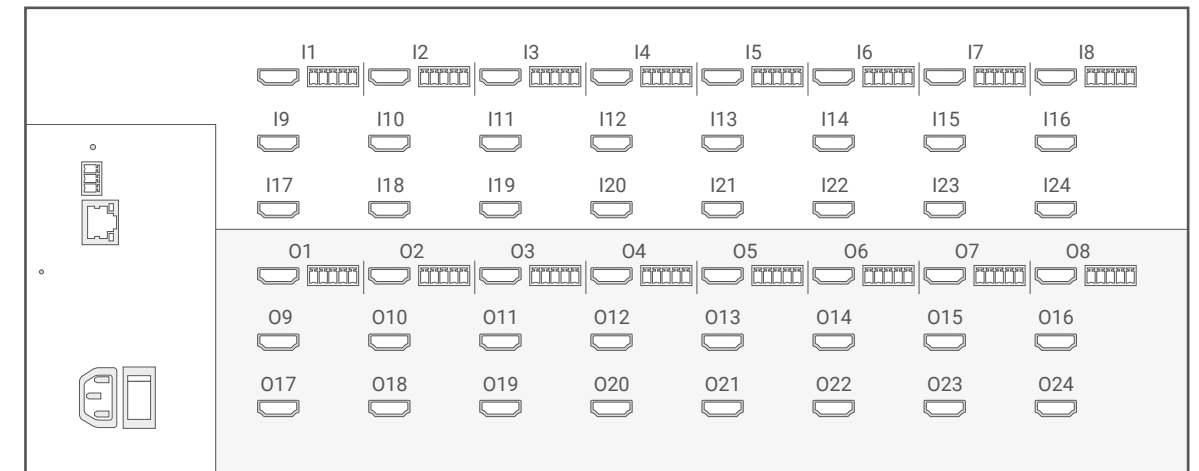

13.7.20. MX2-24x24-HDMI20-R

HDMI Input port nr.	HDMI Output port nr.	DP Input port nr.	DP Output port nr.	Audio Input port nr.	Audio Output port nr.
1-24	1-24	-	-	-	-

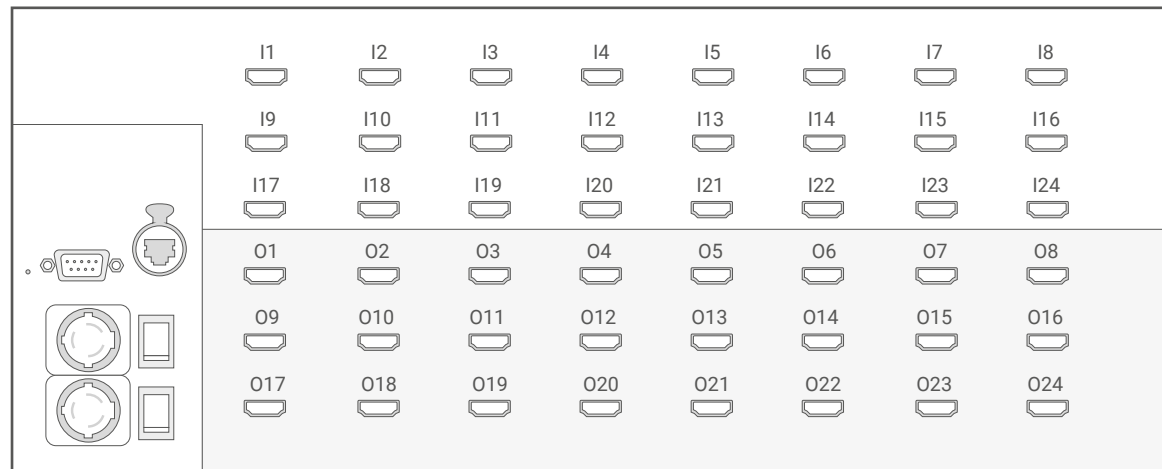
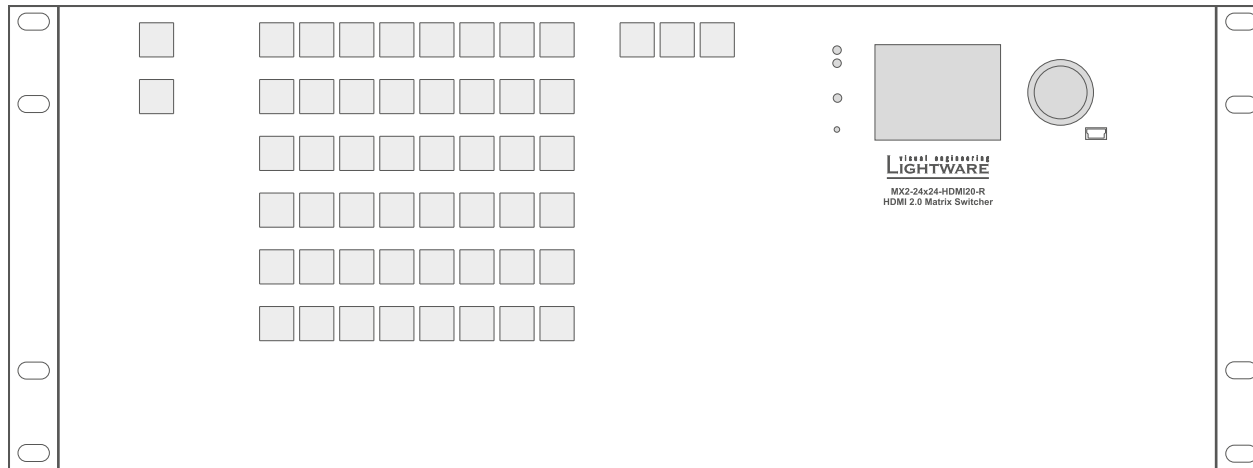

13.7.21. MX2-24x24-HDMI20-Audio-R

HDMI Input port nr.	HDMI Output port nr.	DP Input port nr.	DP Output port nr.	Audio Input port nr.	Audio Output port nr.
1-24	1-24	-	-	1-8	1-8

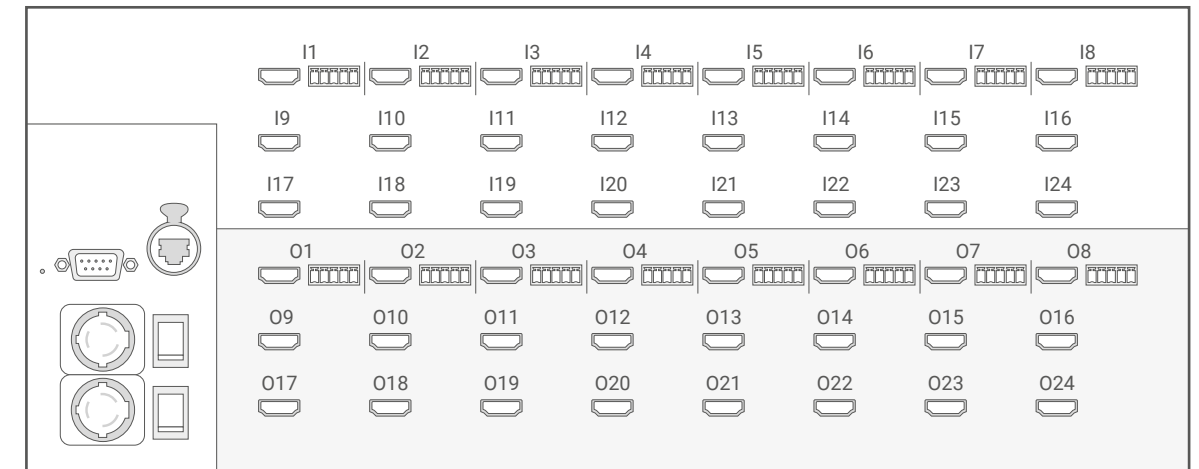
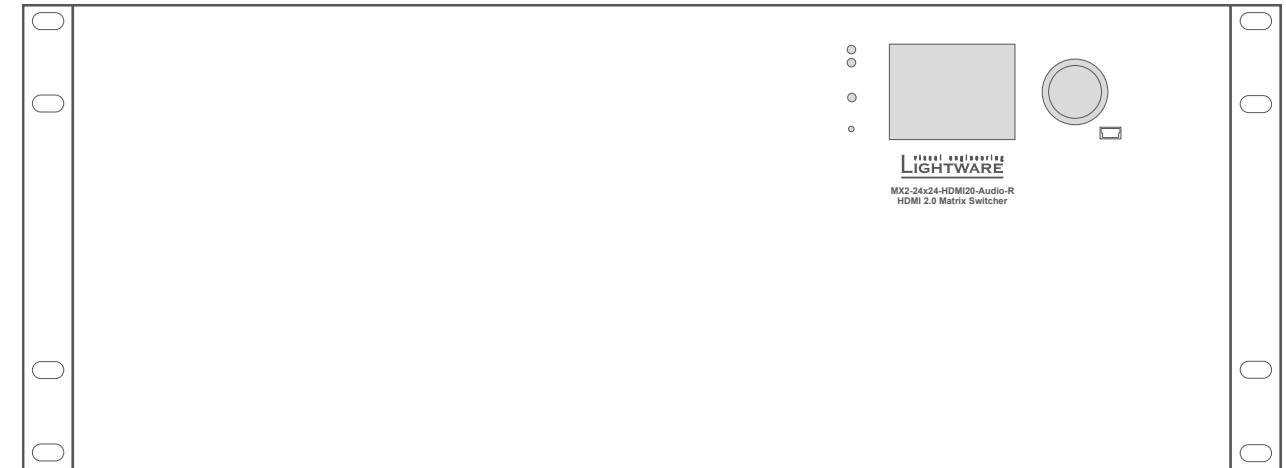

13.7.22. MX2-24x24-DH-12DPi-R

HDMI Input port nr.	HDMI Output port nr.	DP Input port nr.	DP Output port nr.	Audio Input port nr.	Audio Output port nr.
13-24	1-24	1-12	-	-	-

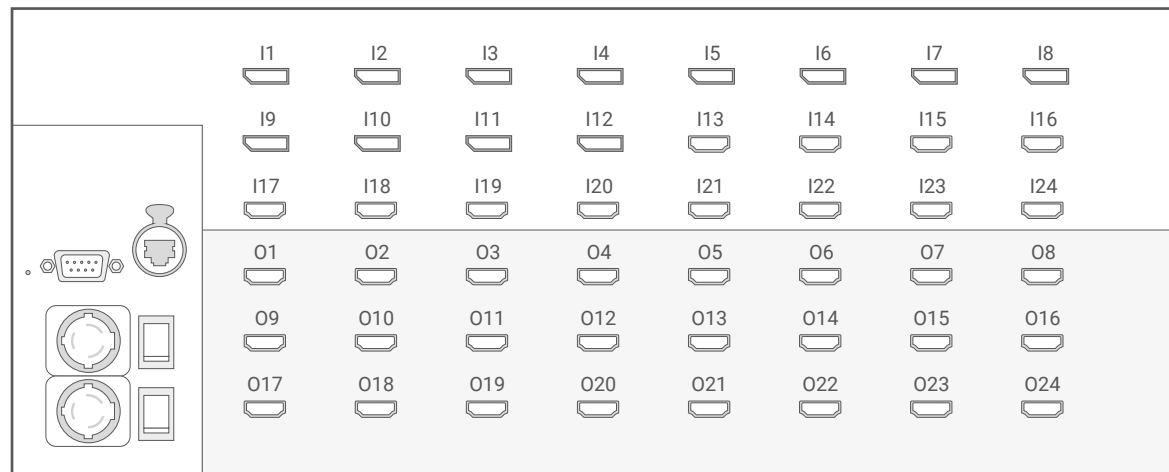
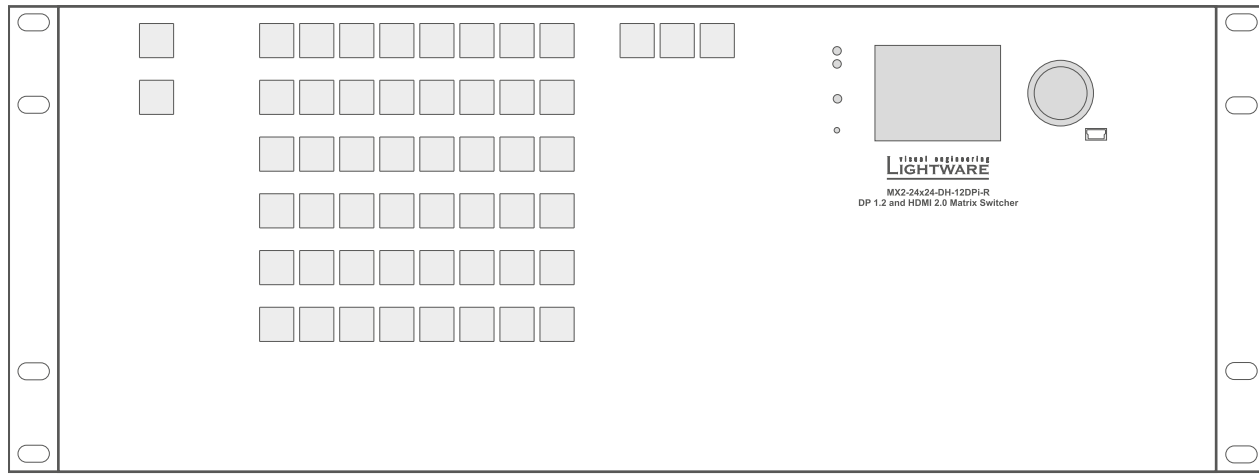

13.7.23. MX2-24x24-DH-12DPi-A-R

HDMI Input port nr.	HDMI Output port nr.	DP Input port nr.	DP Output port nr.	Audio Input port nr.	Audio Output port nr.
13-24	1-24	1-12	-	9-12; 17-24	1-8

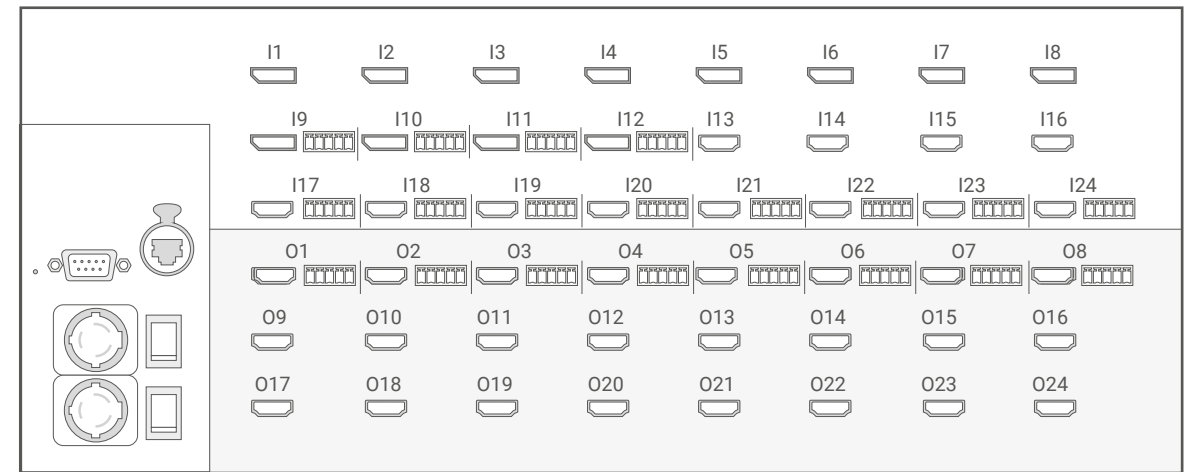
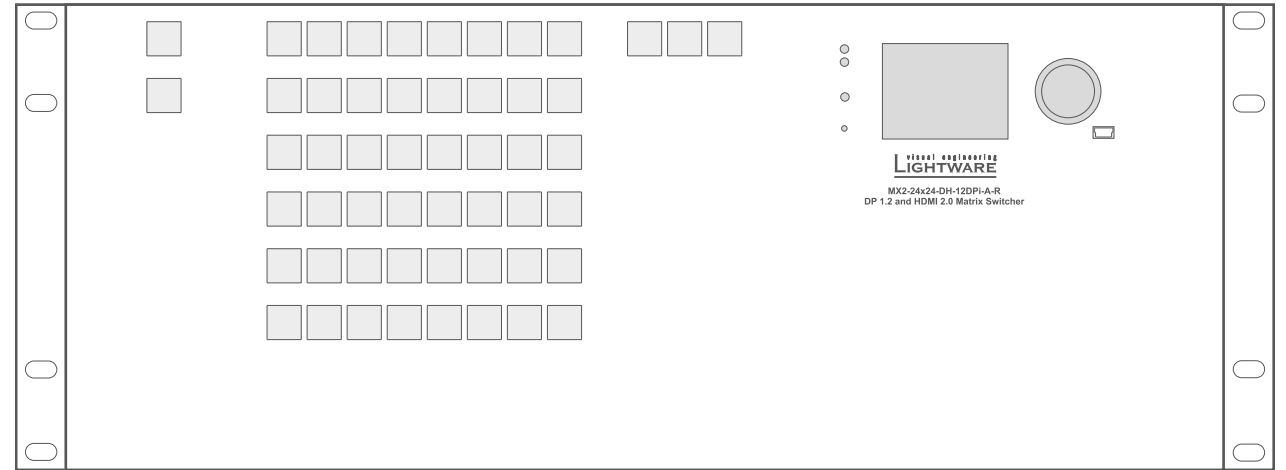

13.7.24. MX2-24x24-DH-24DPio-A-R

HDMI Input port nr.	HDMI Output port nr.	DP Input port nr.	DP Output port nr.	Audio Input port nr.	Audio Output port nr.
-	-	1-24	1.24	1-8	1-24

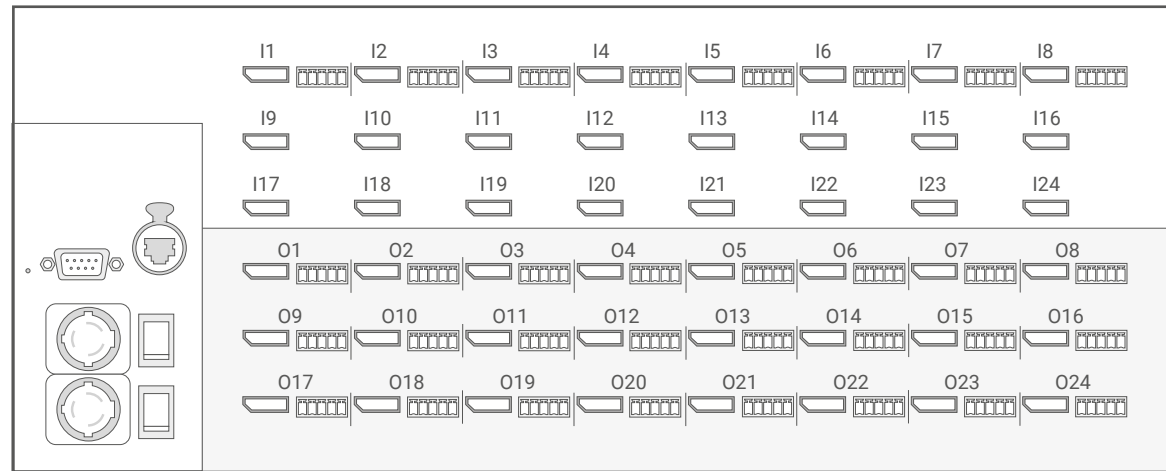
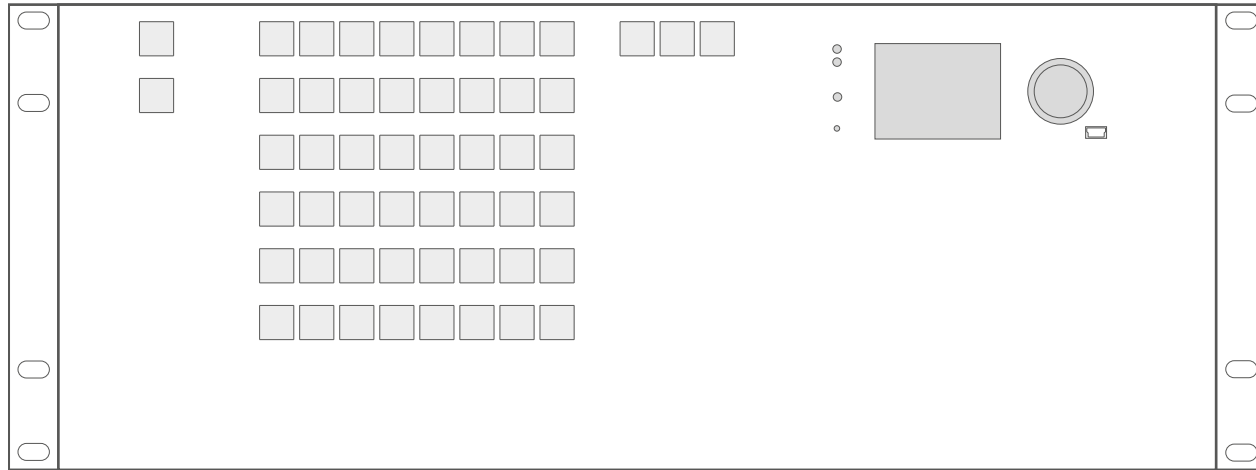

13.7.25. MX2-32x32-HDMI20-A-R

HDMI Input port nr.	HDMI Output port nr.	DP Input port nr.	DP Output port nr.	Audio Input port nr.	Audio Output port nr.
1-32	1-32	-	-	1-16	1-16; 33-40

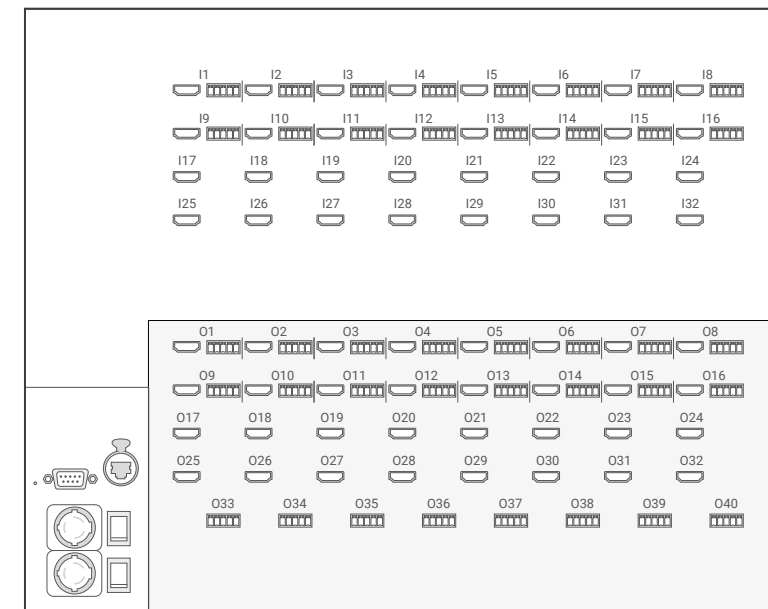
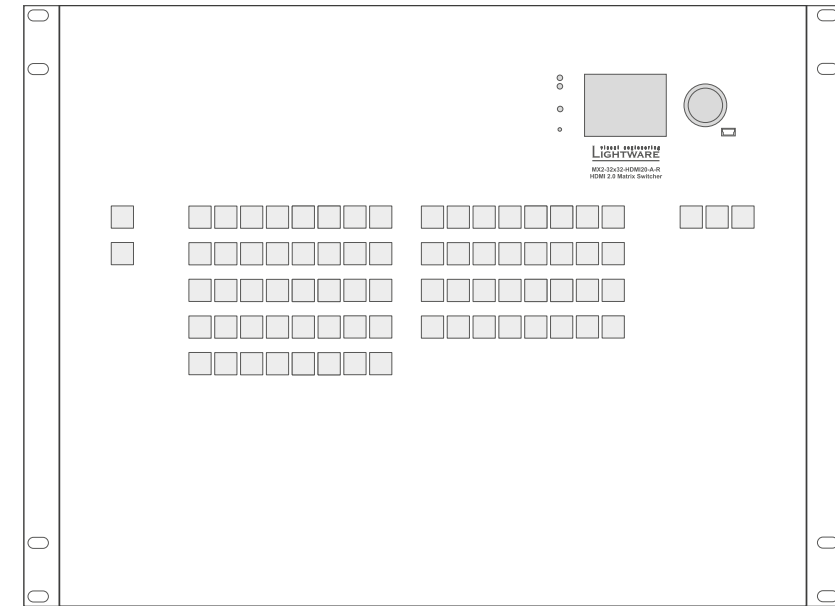

13.7.26. MX2-32x32-DH-16DPi-A-R

HDMI Input port nr.	HDMI Output port nr.	DP Input port nr.	DP Output port nr.	Audio Input port nr.	Audio Output port nr.
17-32	1-32	1-16	-	9-12; 17-24	1-16; 33-40

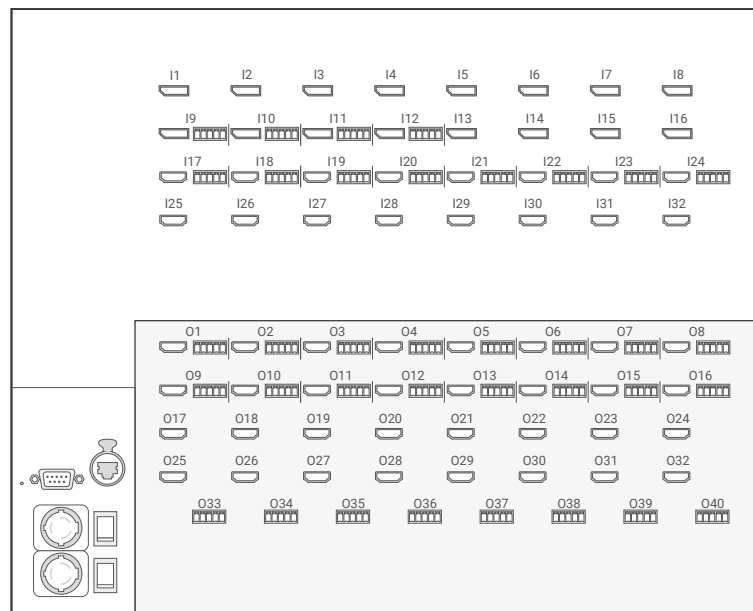
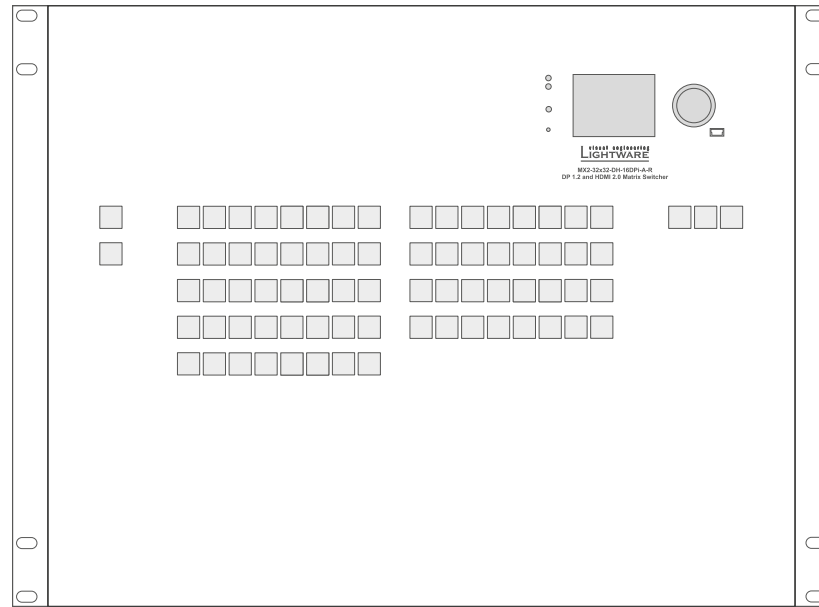

13.7.27. MX2-48x48-HDMI20-A-R

HDMI Input port nr.	HDMI Output port nr.	DP Input port nr.	DP Output port nr.	Audio Input port nr.	Audio Output port nr.
1-48	1-48	-	-	1-16	1-16

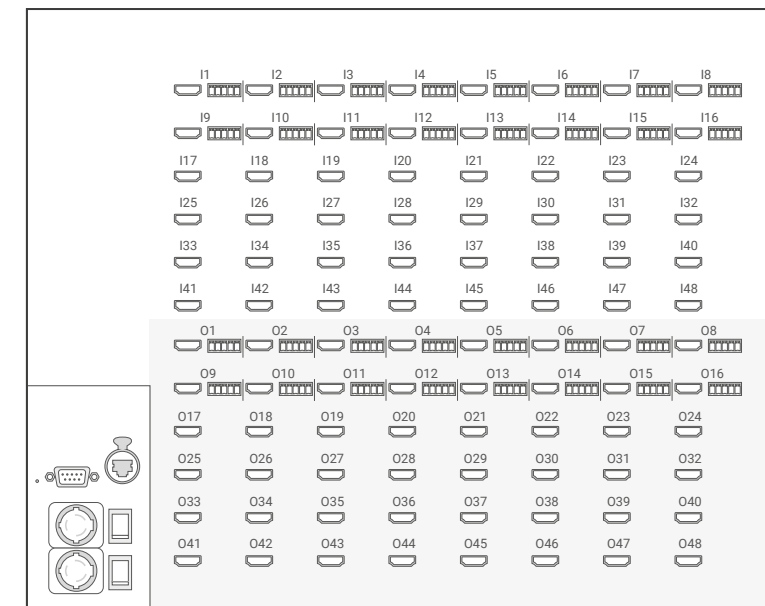
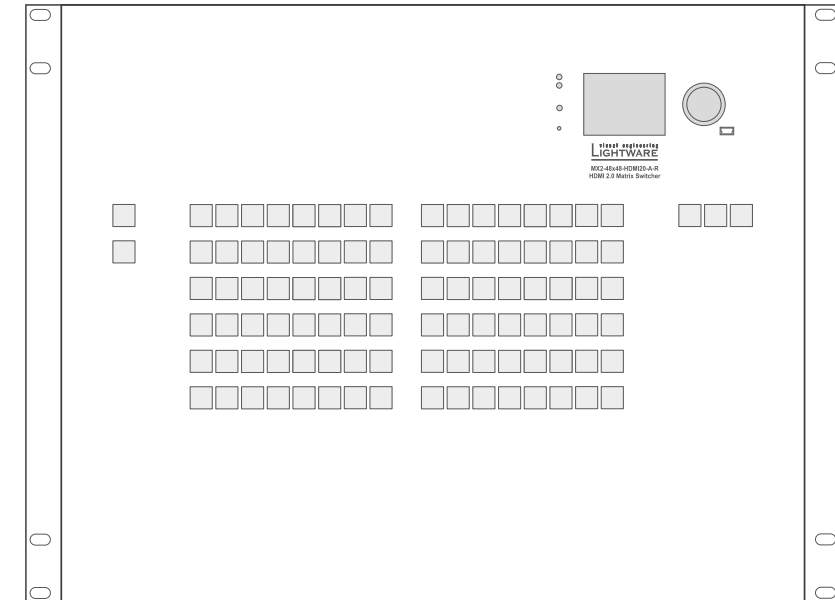

13.7.28. MX2-48x48-DH-24DPio-A-R

HDMI Input port nr.	HDMI Output port nr.	DP Input port nr.	DP Output port nr.	Audio Input port nr.	Audio Output port nr.
25-48	25-48	1-24	1-24	1-8; 25-32	1-32

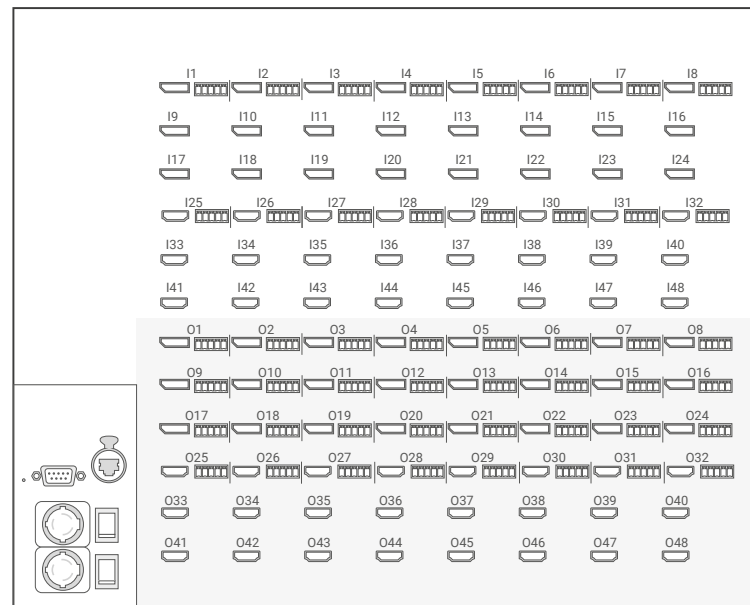
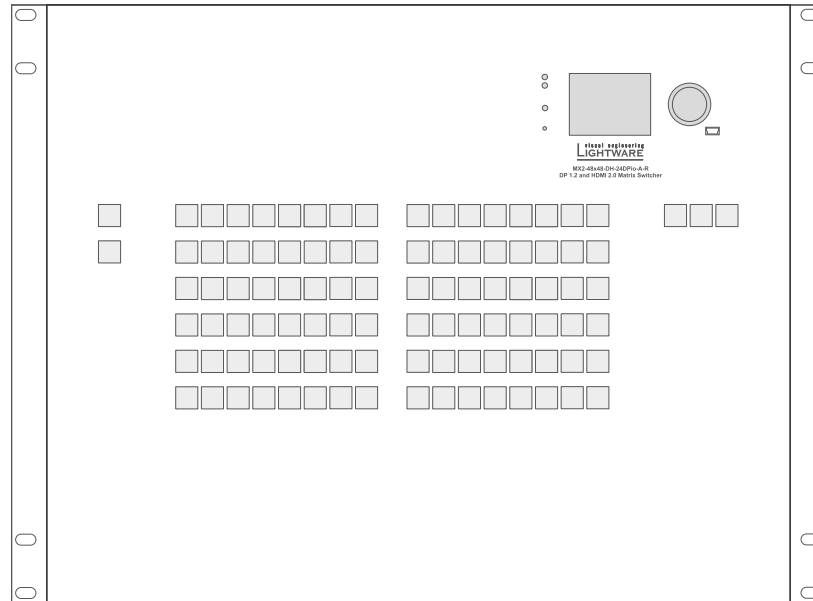

13.7.29. MX2-48x48-DH-48DPi-A-R

HDMI Input port nr.	HDMI Output port nr.	DP Input port nr.	DP Output port nr.	Audio Input port nr.	Audio Output port nr.
-	1-48	1-48	-	1-16	1-16

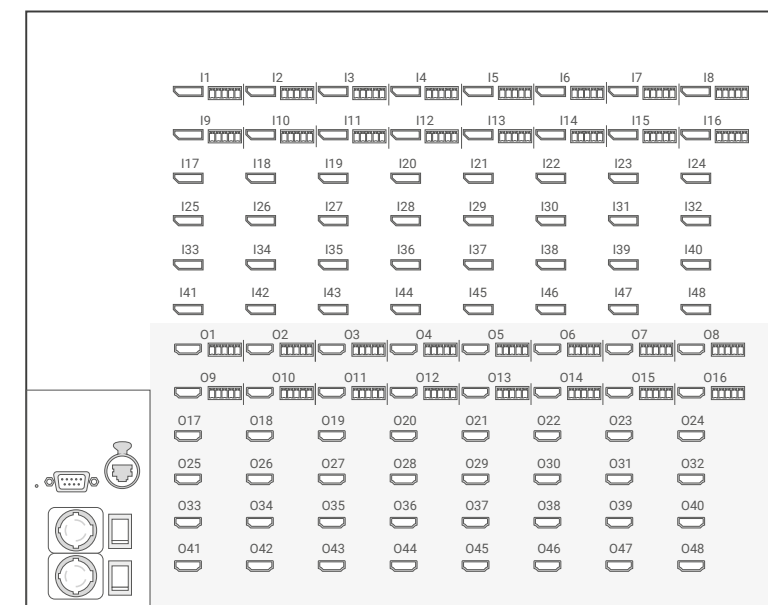
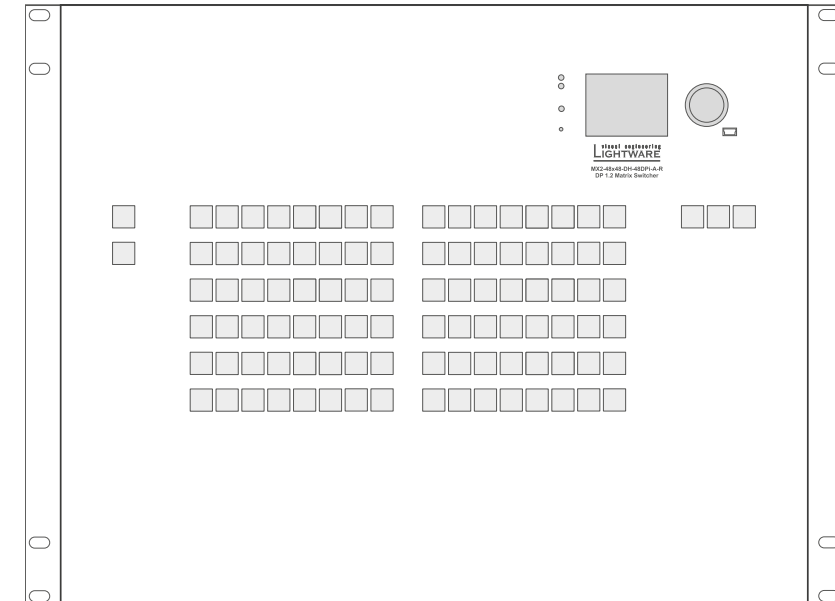

13.7.30. MX2-48x48-DH-48DPio-A-R

HDMI Input port nr.	HDMI Output port nr.	DP Input port nr.	DP Output port nr.	Audio Input port nr.	Audio Output port nr.
-	-	1-48	1-48	1-16	1-48

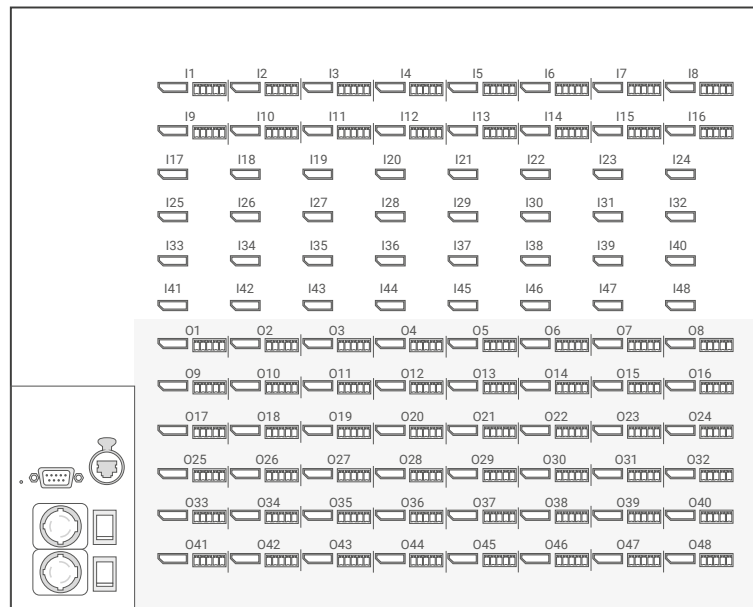
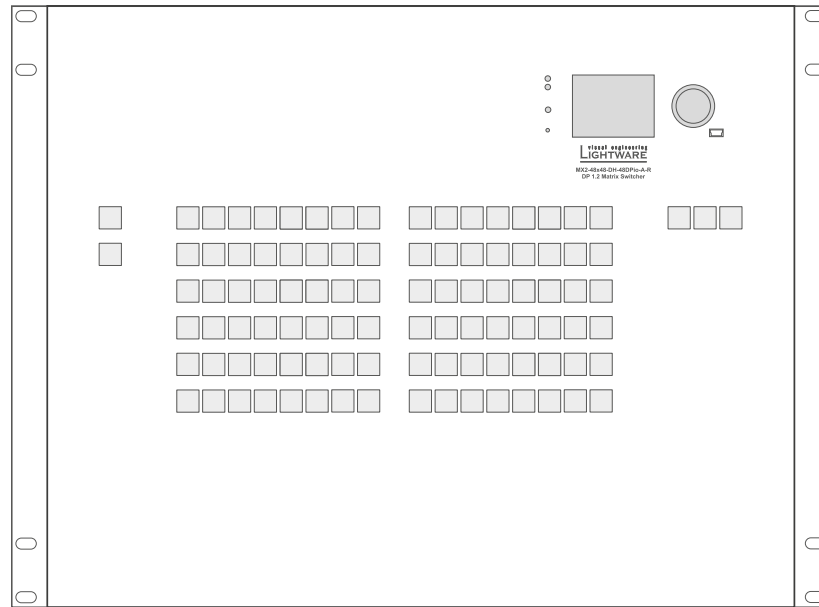

13.8. Direction of the Airflow

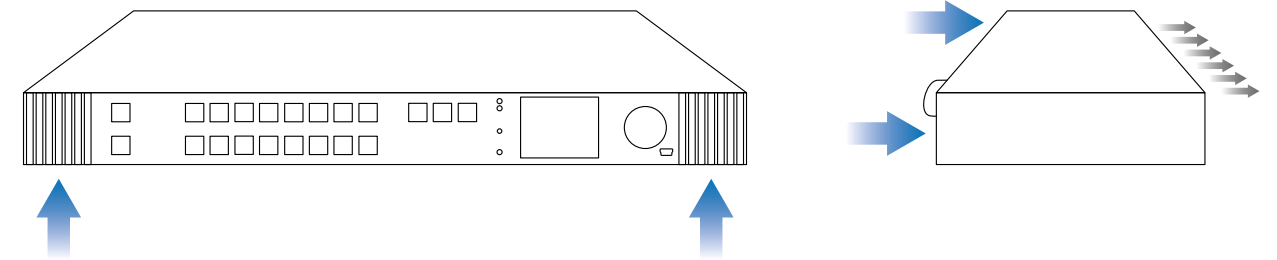

13.9. Release Notes of the Firmware Packages

The list below shows the released firmware packages with important notes.

v1.11.0b2

Release date: 2024-06-04

New feature:

- Added an option to set up automatic restart of the matrix.

Bugfix:

- Fixed a bug that caused the wrong date to be set up when manually adjusting the current (local) time through LDC.

v1.10.1b4

Release date: 2023-11-17

Bugfix:

- Fixed a bug that caused the service page to erroneously report that the matrix is not up to date after a successful firmware upgrade.
- Fixed a bug that resulted in the video signal not being recognized when emulating an EDID with DisplayID on the DP inputs.
- Fixed a bug that resulted in the unreliable update of the DP output module during a firmware upgrade.

v1.10.0b5

Release date: 2023-06-12

New feature:

- From this version on, the MX2-16x16-DH-16DPi-R matrix variant is supported.

v1.9.2b4

Release date: 2023-01-23

Bugfix:

- Fixed a bug that resulted in unstable signal on DP outputs.
- Fixed a bug that resulted in unstable operation on DP inputs.
- Fixed a bug that resulted in invalid HDCP operation on the output.
- Fixed a bug that resulted in the CEC commands not taking effect if the matrix output is looped back to the input.
- Fixed a bug that resulted in the output not showing an image after several crosspoint switches between 4k@60Hz video signals.
- Fixed a bug that resulted in signal stability issues on the output when the matrix was passing a 4k@24Hz signal.

Known issue:

- There are incompatibility issues on the DisplayPort outputs with certain LED display controllers.
- The horizontal scroll bar does not work in the crosspoint view.
- The output video is not displayed on video sink devices that cannot process several general control packets (GCP) when the signal is looped through the matrix several times. (Each such loop increases the number of GCP packets by two.)

v1.9.0b10

Release date: 2022-06-08

Bugfix:

- Improved on the GUI update time particularly for large matrices.
- Fixed a bug that resulted in unstable TMDS clock on the output after crosspoint switching.
- Fixed a bug that resulted in the channel status information corresponding to a matrix output to erroneously indicate a channel number of 5.1.
- Fixed a bug that resulted in tickling noise on the analog audio output.
- Fixed a bug that caused the signal to be lost on the matrix output.
- Fixed a bug that resulted in HDCP content protection still being used after the source disabled it on the fly. From this version on, no HPD event (cable unplugging and replugging) is required to update the HDCP state in such cases.
- Fixed a bug that resulted in visual artifacts in the video signal output by the matrix.
- Fixed a DisplayID bug that resulted in wrong signal parameters measured on the matrix input for extra wide signal formats (e.g. for 5120x2160p30).

v1.8.3b1

Release date: 2022-05-25

Bugfix:

- Fixed a bug that prevented the MX2-8x8-DH-4DPio-A matrix version from being programmed for the first time during production.

v1.8.2b2

Release date: 2022-04-04

Bugfix:

- Fixed a bug that caused the matrix to reprogram itself upon a power cycle.

v1.8.1b7

Release date: 2022-03-09

New feature:

- From this version on, the MX2-48x48-DH-48DPi-A-R matrix variant is also supported.
- From this version on, the MX2-8x8-DH-4DPio-A matrix variant is also supported.

Bugfix:

- Fixed a bug that caused one of the analog audio channels to be set to very low volume.
- Fixed a bug that resulted in erroneous report of failed update by the LDU2.
- Fixed a bug that caused the +5V to be turned off on an HDMI output after rebooting the matrix.
- Improved the reliability of the video port processors on the output.
- Fixed a bug that caused the bigger MX2 standalone matrices to erroneously report that booting failed after a factory reset.

Known issue:

- Occasionally, for deep color signals, wrong resolution is detected on the output.
- Occasionally, the output frame rate is not detected correctly.
- The port selector and the corresponding Mute and Lock buttons for the last input of the matrix switcher is missing from the crosspoint view of the embedded web. These widgets are present in the standalone LDC application.
- The DisplayPort input of the matrix switcher might occasionally get stuck. In such cases, the input signal is not forwarded to the output.
- All audio formats, including the compressed ones, are deembedded to the analog audio output on the output side of the matrix.
- It might happen that even though the HDCP is not enabled on a DP input of the matrix (HdcpVersion = 0), the source sends HDCP encrypted content.
- Any change in the HDCP level on the input by the source which is not accompanied by a change in the +5V signal is not recognized by the matrix switcher.

- Changing the audio source from HDMI to ANALOG on the input results in approximately 1 second of noise on the output before the audio is stabilized.
- Invalid signal type or TMDS error rate is reported by the matrix for the version v1x input and output modules, respectively, if they do not pass video signal.
- The audio mode setting on the DP output of the matrix is seemingly preserved over a power cycle. However, after the matrix is restarted, the audio will always be output on the DP and on the corresponding analog output (if any) regardless of the settings. Toggling the setting will enforce correct operation.

v1.7.0b17

Release date: 2021-01-26

New feature:

- From this version on, product variant with 16 HDMI input ports and 8 HDMI output ports (MX2-16x8-HDMI20-Audio-R) is also supported.
- From this version on, DisplayID is supported by the matrix and is passed on to the video source through the EDID. With the help of DisplayID, exotic dimensions (e.g. 7680 x 1080) not supported by regular EDID can also be set.

Bugfix:

- Fixed a bug that caused the input signal not to be recognized on a DisplayPort input after restarting the matrix.
- Fixed a bug that resulted in signal flashing on the DisplayPort outputs.
- Fixed a bug that resulted in the matrix not being accessible through ssh or through the embedded web.
- Improved the reliability of the video port processors.
- Improved on the error resilience of the DP output boards.

Known issue:

- Conversion to 422 does not work if the bit depth of the input video signal is equal to or greater than 10 bits/component.
- The channel status information in the output HDMI stream erroneously reports 5 channel PCM when embedding audio through the analog audio input on the input side of the matrix.
- The device label is not reset to its factory default value when the matrix is factory reset.
- Downgrading from package version v1.7.0 might render the matrix inaccessible through LDC.
- The DP output erroneously reports a frame rate of 30Hz for input signals having a frame rate of 60Hz and a sampling pattern of 4:2:0. Moreover, the color space information is missing for such input signals.
- The EDID extension block that contains the DisplayID information is not exported when a dat format is selected for export. To circumvent the problem, use the bin format.
- The incoming video is converted to DVI and any audio content is removed on the HDMI or DP input, if an EDID with DisplayID extension is selected for emulation to the connected video source.

- When an EDID with DisplayID extension is emulated to the HDMI output by the connected sink, the output video signal is converted to DVI and any audio content is removed.

v1.6.2b1

Release date: 2020-05-20

Bugfix:

- Fixed a bug that prevented higher class SDHC cards from being used in the matrix.

v1.6.1b4

Release date: 2020-03-10

Bugfix:

- Fixed a bug that caused the audio output on a HDMI output board to be lost within a brief period of time after crosspoint switching.
- Fixed a bug that caused audio popping on a HDMI output after crosspoint switching.

v1.6.0b10

Release date: 2020-01-27

Bugfix:

- Fixed a bug that resulted in multiple Hardware version lines for the same hardware in the LCD menu.
- Fixed a bug that caused some settings of the DisplayPort input to be lost thus their values not to be stored.
- Fixed a bug that prohibited presets from being saved or recalled from the front panel LCD screen on matrix variants without control panel keys.
- Improved on the reliability of device upgrade.

Known issue:

- Swing and pre-emphasis values might not be rendered correctly on the graphical user interface.
- If the DisplayPort input stream has no embedded audio and it is routed to a DisplayPort output, video signal stability issues (blinking) may arise on the output. Furthermore, when embedding audio in such streams on the input, video signal instability may also be accompanied with audio popping on the output. The issue can be eliminated by repeating link training on the input.
- The USB interface will not work when an USB cable is connected to the USB port on a matrix variant with 32 or more input and output ports during booting.
- The support for some audio formats might get removed from the EDID read on DisplayPort outputs.
- Color space information on the graphical user interface might not be accurate for the DP outputs.
- DisplayPort related forced settings (e.g. DpForcedMode) on the output DisplayPort board are preserved after restoring the matrix to factory defaults.
- The signal on a DisplayPort input might not get recognized (and consequently, not routed to the selected output) after the matrix is restarted. Triggering a new link training on the input resolves the problem.

v1.5.1b5

Release date: 2019-11-11

Bugfix:

- Fixed a bug that resulted in no embedded audio in the HDMI stream on HDMI only output boards after resetting the matrix to factory default settings.
- Made improvements to manufacturing.

v1.5.0b6

Release date: 2019-10-11

New feature:

- Added support of MX2-48x48-HDMI20-A-R, MX2-32x32-HDMI20-A-R and MX2-32x32-DH-16DPi-A-R devices.

Bugfix:

- Fixed a bug that caused the upgrade of certain MX2 variants to fail when the device was set to a fix IP address.
- Fixed a bug that presets were ordered on the LCD menu randomly. Now they are ordered in a numerical order.
- Fixed a bug that made impossible saving new presets from the front panel buttons.
- Fixed a bug that made preset names unreadable on the LCD screen if there were more than six presets saved.
- Fixed a bug that caused HDMI 5V being low on the outputs after a firmware upgrade. This issue was happening only until the first reboot after upgrading the firmware.
- Fixed a bug that caused incompatibility between RCP control panels and matrices while using P#2 protocol.
- Fixed a bug that caused not fetching new IP address from the DHCP server when ethernet cable was removed and plugged again.

v1.4.2b11

Release date: 2019-07-23

Bugfix:

- Fixed a bug that caused MX2-8x8-HDMI20-Audio (part number: 91310033) not to pass an input video signal of 4k@60Hz 4:4:4.
- Audio port submenus next to DisplayPort input ports were missing on the LCD screen in variant MX2-24x24-DH-12DPi-A-R
- Routing video signal from input 6 to output 6 and output 13 was unstable when the internal temperature has reached about 35-40 C. The issue was affecting only MX2-16x16-HDMI20(-AUDIO)(-R), MX2-24x24-HDMI20(-AUDIO)(-R), MX2-16x16-DH-8DPi-A-R, MX2-24x24-DH-12DPi-A-R and MX2-24x24-DH-12DPi-R variants.

- Fixed a bug that might have resulted in unusually long or failed upgrade.
- Fixed a bug that might have resulted in some components not to be upgraded properly during firmware upgrade.
- Input and output port firmware upgrade failed in MX2-8x8-HDMI20-AUDIO and MX2-8x8-HDMI20-AUDIO-L variants with v1.4.1 firmware.
- Firmware upgrade has been failed in some rare cases.
- Displayport input cards have truncated 10 and 12 bit deep color signals to 8 bit in every case.

Known issue:

- Firmware upgrade fails when IP address is set to static instead of DHCP.

v1.4.1b1

Release date: 2019-06-13

Bugfix:

- Fixed a bug that caused a DisplayPort input port not to send EDID information to the connected video source after a cold boot. EDID communication was OK after the input was switched to a different output.

Known issue:

- MX2-8x8-HDMI20-Audio (part number: 91310033) does not pass an input video signal of 4k@60Hz 4:4:4.

v1.4.0b11

Release date: 2019-05-30

New feature:

- From this version on, HDR infoframe together with its meaning in human readable format are displayed in LDC.
- From this version on, CEC is supported on both the inputs and outputs of all matrix variants.
- From this version on, AVI and Audio infoframes are decoded and displayed in human readable format.
- From this version on, DP input variants and new small form factor variants are also supported.

Bugfix:

- Fixed a bug that caused the /MEDIA/PORTS/VIDEO/Oxx/STATUS.EmbeddedAudioPresent property to always have a false value on an output port even though there is embedded audio in the HDMI stream routed to the respective output port.
- Fixed a bug that resulted in the /MEDIA/PORTS/VIDEO/Oxx/EMBEDDEDAUDIO node (where xx is the port number) not to be refreshed when the input signal ceased on the input routed to the respective output.
- Fixed a bug that resulted in the partial loss of saved settings on random occasions which might have caused the LCD screen to go blank.

Known issue:

- Refreshing the LCD menu screen that shows the status of all input or output ports when changes in multiple ports occur at the same time causes high CPU usage and results in unresponsive operation.
- It might happen that although the IP address of the matrix is correctly displayed in LDC, it is not possible to connect to it.
- The reported value of channel status bytes might differ from the actual value in the audio stream contained within the HDMI stream.
- A 4k@30Hz 4:4:4 10 or 12 bit signal on the displayport inputs gets truncated to 8 bits.
- Enabling the test pattern on DisplayPort inputs works sporadically.
- After a backup-restore cycle the lock and mute states of the video ports might not get restored.

v1.3.5b2

Release date: 2019-03-22

Bugfix:

- Fixed a bug that resulted in uninformative popup message when the opened package requires newer version of LDU2.
- Fixed a bug that resulted in HDCP noise on the output when the HDCP 2.2 authentication had to be repeated on the corresponding output due to e.g. unplugging and replugging the HDMI cable.
- Fixed a bug that resulted in invalid frame rate and pixel frequency to be measured and reported.

v1.3.4b10

Release date: 2019-03-13

Bugfix:

- Fixed a bug that caused a 10 bit YUV 4:2:2 bit input format to be transmitted as 8 bit YUV 4:2:2 on the output.
- Fixed a bug that resulted in loss on the output port when a crosspoint change affecting the respective output occurred and then the crosspoint state prior to the change was reset.
- Fixed a bug that caused the Audio menu on the LCD not to be displayed for certain input and output ports.
- Fixed a bug that resulted in the button panel of an MX2-16x16 or 24x24 matrix to be initialized as the button panel of an MX2-8x8 matrix, thus only the first 16 buttons were working.
- Fixed a bug that caused the input video signal not to be output on the output video port due to invalid signal parameters detection.

v1.3.3b2

Release date: 2019-01-17

Bugfix:

- Fixed a bug which had an effect on manufacturing the unit.

v1.3.2b2

Release date: 2018-11-22

Bugfix:

- Fixed a bug that resulted in the matrix switcher not being able to output an 4k@60Hz 4:2:0 signal.

v1.3.1b7

Release date: 2018-11-06

Bugfix:

- Fixed a bug that prevented the audio from being removed from the HDMI output when the Audio output parameter was set to Analog or Off.
- Fixed a bug that resulted in a ticking noise in the embedded audio when the volume was changed on the input.
- Fixed a bug that prevented the embedded audio from being de-embedded to the analog input when a 4k@60Hz 4:4:4 video with embedded LPCM audio was switched to an output port, and no HDMI sink (e.g. no display) was connected to the actual output.
- Fixed a bug that resulted in empty Port property window on MX2-8x8-HDMI20-Audio(-L).
- Fixed a bug that resulted in the sampling pattern conversion from 4:4:4 to 4:2:2 not to work for 4k@60Hz signals.
- Fixed a bug that prevented TMDSErrorCounter from being read by an attached sink on an output with HDMI1.4 signal.
- Fixed a bug that resulted in a ticking noise on the output when the volume is changed.

Known issue:

- If sampling pattern conversion from 4:4:4 to 4:2:2 is enabled on the output, and the cable is removed and plugged in again, the conversion will be turned off.

v1.3.0b21

Release date: 2018-10-29

New feature:

- Added support for MX2-16x16-HDMI20 and MX2-24x24-HDMI20 product variants.

Known issue:

- Compressed audio can be de-embedded to the analog output which results in audible noise.
- The video parameters are not valid on an output when no sink is connected to the respective output port.
- The value of the MaxSupportedHDCPVersion property on the output is stuck in HDCP2.2 regardless of the HDCP version supported by the attached sink. The problem does not affect the functionality.
- The values in Input Ports > Port [n] > Video Settings > Audio Source and Input Ports > Port [n] > Analog Audio > Audio Source on the LCD display might contain ambiguous information.

- The STATUS.EmbeddedAudioPresent property on the output has a value of 'false' even though there is embedded audio in the HDMI output signal.
- The video signal conversion on the output is not reflected in the video parameters, although the conversion is performed.
- When a 4k@60Hz 4:4:4 video with embedded LPCM audio is switched to an output port, and no HDMI sink (e.g. no display) is connected to the actual output, the embedded audio cannot be de-embedded to the analog output.
- The EDID read from a sink connected to an output port might contain EDID extension portions previously read from a different sink connected to the same output port.
- A ticking noise can be heard on the output when the volume is changed.
- A ticking noise can be heard in the embedded audio when the volume is changed on the input.
- The audio is not removed from the HDMI output even though the Audio output parameter is set to Analog or Off.
- EDID cannot be read on the inputs when the matrix is in Standby state.
- The Health Status screen for the output ports on the LCD display cannot be scrolled.
- Sampling pattern conversion from 4:4:4 to 4:2:2 only works for 4k@60Hz.
- The Signal type parameter on the output has no effect on whether DVI or HDMI signal is sent by the matrix. Instead, the signal type is determined by the interface standard in the basic display parameters of the EDID read on the respective output.

v1.2.3b5

Release date: 2018-06-11

New feature:

- Added MX2-8x8-HDMI20-AUDIO-L frame support.

Bugfix:

- Fixed an issue that produced multiple hotplug pulses on the inputs. Although this does not violate the standard, it may cause compatibility issues with certain devices (like Barco Eventmaster).
- Fixed a bug that once in a while caused the connected input or output ports to show invalid pixel clock rates. If the output port is affected, the video does not appear on the connected display.

v1.2.2b10

Release date: 2018-03-28

Bugfix:

- Fixed a bug that might cause a video port to hang when the CEC I2C communication is slow (e.g. when using DP to HDMI adaptors).
- Fixed a bug that caused DDC communication to fail when the source was using clock stretching.

v1.2.1b4

Release date: 2017-12-18

New feature:

- New factory EDIDs have been added. F146 is an HDR EDID, F147 and F148 are 4k60 VESA-CVT RB EDIDs.

Bugfix:

- Fixed a bug that caused the matrix to be stuck in a reboot cycle when the internal database was corrupted by restoring the factory default settings.

v1.2.0b7

Release date: 2017-11-23

New feature:

- From this version on, the matrix supports CEC functionality.
- From this version on, the matrix will retry DDC communication when it fails after connecting a device to the output port.

Bugfix:

- Fixed a bug that caused the resolution not to be calculated properly for a 4:2:0 input video.
- Fixed a bug that caused the audio to be attenuated instead of being muted.

v1.1.6b3

Release date: 2017-09-04

New feature:

- Added the LW2 recall preset command (in the form of {<preset>}) to the LW2 command pool where <preset> is the name of the preset to be recalled.
- Modified the input equalization settings to improve performance when a device is connected to the matrix by a short HDMI cable.

Bugfix:

- Fixed a bug that caused the Advanced tab on the IO ports panel not to be refreshed automatically upon parameter value changes.

v1.1.5b1

Release date: 2017-08-16

New feature:

- Added "High value mode" option to inputs. This mode prevents HDCP1.x sinks from interacting with sources producing high value HDCP 2.2 protected content.
- The 'Signal error rate' field of the Port property panel has been moved to the 'Advanced' tab.
- We have added a new option (High Value mode) to the HDCP enable field on the Port properties panel.
- We have added tooltip for the HDCP Enable field on the Port properties panel.

- We have updated the HDCP capability field on Port properties panel of output ports to display more detailed information.
- We have added a new 'Advanced' tab to the Port properties panel with the following new fields: BCH ECC errors (input ports only), Infoframes, Scrambling, Clock rate.
- Added HDCP "High Value mode" to LCD menu.

Bugfix:

- We have fixed a bug that prevented the pin of slider control elements to be dragged by mouse.
- We have removed the Conversion mode field from the Port properties panel of input ports as the device now allows conversion on output ports only.
- We have fixed the bug that the EDID Creator failed to create correct binary files during saving.

Known issue:

- Scrollbars on Firefox are not displayed properly.
- Some pop-up windows may not be displayed in IE, Edge and Safari.
- Exporting files is not supported in Safari.

v1.1.4b6

Release date: 2017-07-31

New feature:

- We are introducing a subpage at http://<matrix_ip_address>/log that allows to retrieve log files from the matrix.

Bugfix:

- Fixed a bug that prevented the LW2 switch command from being executed.
- Improved IO port firmware update stability.
- Fixed a bug that caused no picture after an EDID switch on the input.
- Fixed stability issues with HDCP 1.4 capable displays.
- Fixed a bug that prevented some sources from authenticating via HDCP 1.4.
- Fixed a bug that caused v13 version of the input board to malfunction during Hot Plug Detect.

v1.1.3b1

Release date: 2017-04-26

Bugfix:

- Fixed a bug that resulted in missing TMDS error rate indicators for some ports.
- Improved crosspoint input equalization.

v1.1.2b4

Release date: 2017-03-17

Bugfix:

- Fixed a bug that resulted in the content of the front panel LCD display to be mirrored.
- Fixed a bug that caused the TCP control connection to be closed unexpectedly by the matrix. After the TCP connection was closed, control could only be regained by power cycling the matrix.

v1.1.1b4

Release date: 2017-03-09

Bugfix:

- Fixed a bug that caused the error registers on the output not to be cleared correctly resulting in false content in the logs.
- Fixed a bug that prevented the internal buzzer from being disabled.
- Fixed a bug that caused the time and date not to be preserved when the unit was power cycled.
- Fixed a bug that limited the number of retry attempts to three when authentication of the attached display failed.
- Fixed a bug that caused some HDCP 1.4 repeaters (e.g. some AV receivers) not to be authenticated properly.
- Fixed a bug that prevented the Lightware Protocol 2 switch command from working.
- Fixed a bug that caused some displays not to authenticate correctly when they were switched on after being connected to the matrix.
- Fixed a bug where the input port mute caused permanent signal loss on the input with HDCP2.2 contents.
- Fixed a bug resulting in the 4:4:4 to 4:2:0 conversion option to remain active when the sampling pattern of the input signal was 4:2:0.
- Fixed a bug that caused the red picture on the display indicating that it was not able to decrypt HDCP-encrypted content to flash when HDCP 2.2 content encryption was used.
- Fixed a bug that caused compatibility issues with non-HDMI2.0 products resulting in inappropriate EDID reading.

v1.1.0b3

Release date: 2017-01-31

New feature:

- We are introducing automatic fan speed control. Now the fan speed is set according to the system temperature.
- From this version on, HDCP 2.2 is supported by the matrix.
- We are introducing support for saving and loading presets. Presets are used to store crosspoint settings and Mute state for ports. Current lock state is reserved when loading a preset.
- We are introducing front panel USB support. The front panel USB connector can now be used for connecting the matrix to a controller computer running the Lightware Device Controller.

v1.0.1b1

Release date: 2016-12-02

Bugfix:

- Fixed a bug that caused the IPv6 address not to be displayed in LDC for the first time.

v1.0.0b1

Release date: 2016-11-20

Known issue:

- Scrollbars on the built-in web are not displayed properly in Firefox.
- Only the last browser tab shows valid data if multiple I/O port property tabs are open in the built-in web.
- Some pop-up windows are not displayed properly in Microsoft Internet Explorer, Microsoft Edge and Safari when the matrix is controlled via the built-in web.
- Fan speed is always set to its maximum value.
- Front panel USB port is not supported.
- Version number is not displayed correctly.
- Currently, HDCP 2.2 is not supported.
- Presets are not supported via the front panel keys and the front panel LCD menu.

13.10. Hashtag Keyword List

This user's manual contains keywords with hashtag (#) to help you to find the relevant information as quick as possible.

The format of the keywords is the following:

#<keyword>

The usage of the keywords: use the **Search** function (Ctrl+F / Cmd+F) of your PDF reader application, type the # (hashtag) character and the wished keyword.

The **#new** special keyword indicates a new feature/function or model that has just appeared in the latest firmware or software version.

Example

#dhcp

This keyword is placed at the DHCP (dynamic IP address) setting in the front panel operation, the Lightware Device Controller (LDC) and the LW3 programmer's reference section.

The following list contains all hashtag keywords placed in the document with a short description belonging to them. The list is in **alphabetical order** by the hashtag keywords.

Hashtag Keyword ↓↑	Description
<i>Tag</i>	Description
<i>#advancedview</i>	Advanced view window
<i>#analogaudio</i>	Analog audio related settings
<i>#audio</i>	Audio related settings
<i>#autotakemode</i>	Autotake mode
<i>#balance</i>	Balance (for analog audio) setting
<i>#builtinweb</i>	Built-in web
<i>#button</i>	Front panel button operations
<i>#cec</i>	CEC related settings
<i>#colorspace</i>	Color space converter related settings
<i>#controllock</i>	Front panel control lock
<i>#controlprotocol</i>	Control protocol (LW2 / LW3) query
<i>#crosspoint</i>	Crosspoint switch setting
<i>#date</i>	Date setting
<i>#devicelabel</i>	Device label
<i>#dhcp</i>	Dynamic IP address (DHCP) setting
<i>#dppower</i>	DisplayPort power setting
<i>#edid</i>	EDID related settings

Hashtag Keyword ↓↑	Description
<i>#firmwareversion</i>	Firmware version query
<i>#framedetector</i>	Frame detector in LDC/built-in web
<i>#gain</i>	Gain (for analog audio) setting
<i>#gridview</i>	Grid view in LDC
<i>#hdcp</i>	HDCP-encryption related setting
<i>#hdr</i>	High Dynamic Range (HDR) related information
<i>#ipaddress</i>	IP address related settings
<i>#label</i>	Device label
<i>#linktraining</i>	DP link training setting
<i>#lock</i>	Port lock settings
<i>#mute</i>	Port mute setting
<i>#network</i>	Network (IP address) related settings
<i>#new</i>	New feature/function of the product
<i>#nosyncscreen</i>	Test pattern (no sync screen) settings
<i>#outputlock</i>	Front panel output lock
<i>#power</i>	Power supply and redundancy related information
<i>#power5v</i>	HDMI 5V power mode setting
<i>#preset</i>	Preset related settings
<i>#reboot</i>	Restarting the device
<i>#redundancy</i>	Power supply and redundancy related information
<i>#reset</i>	Restarting the device
<i>#restart</i>	Restarting the device
<i>#rs232</i>	RS-232 related settings
<i>#rs-232</i>	RS-232 related settings
<i>#scrambling</i>	Scrambling setting
<i>#serial</i>	RS-232 related settings
<i>#standby</i>	Standby power mode setting
<i>#status</i>	Status query
<i>#switch</i>	Crosspoint switch setting
<i>#takemode</i>	Take mode
<i>#terminal</i>	Advanced view window
<i>#testpattern</i>	Test pattern (no sync screen) settings
<i>#tileview</i>	Tile view in LDC
<i>#time</i>	Time setting

Hashtag Keyword ↓↑	Description
<i>#unlock</i>	Port unlock settings
<i>#unmute</i>	Port unmute setting
<i>#volume</i>	Volume (for analog audio) setting
<i>#web</i>	Built-in web

13.11. Further Information

Limited Warranty Statement

1. Lightware Visual Engineering PLC (Lightware) warrants to all trade and end user customers that any Lightware product purchased will be free from manufacturing defects in both material and workmanship for three (3) years from purchase unless stated otherwise below. The warranty period will begin on the latest possible date where proof of purchase/delivery can be provided by the customer. In the event that no proof can be provided (empty 'Date of purchase' field or a copy of invoice), the warranty period will begin from the point of delivery from Lightware.

1.1. 25G and MODEX product series will be subject to a seven (7) year warranty period under the same terms as outlined in this document.

1.2. If during the first three (3) months of purchase, the customer is unhappy with any aspect of a Lightware product, Lightware will accept a return for full credit.

1.3. Any product that fails in the first six (6) months of the warranty period will automatically be eligible for replacement and advanced replacement where available. Any replacements provided will be warranted for the remainder of the original unit's warranty period.

1.4. Product failures from six (6) months to the end of the warranty period will either be repaired or replaced at the discretion of Lightware. If Lightware chooses to replace the product, then the replacement will be warranted for the remainder of the original unit's warranty period.

2. The above-stated warranty and procedures will not apply to any product that has been:

2.1. Modified, repaired or altered by anyone other than a certified Lightware engineer unless expressly agreed beforehand.

2.2. Used in any application other than that for which it was intended.

2.3. Subjected to any mechanical or electrical abuse or accidental damage.

2.4. Any costs incurred for repair/replacement of goods that fall into the above categories (2.1., 2.2., 2.3.) will be borne by the customer at a pre-agreed figure.

3. All products to be returned to Lightware require a return material authorization number (RMA) prior to shipment, and this number must be clearly marked on the box. If an RMA number is not obtained or is not clearly marked on the box, Lightware will refuse the shipment.

3.1. The customer will be responsible for in-bound and Lightware will be responsible for out-bound shipping costs.

3.2. Newly repaired or replaced products will be warranted to the end of the originally purchased product's warranty period.

Document Revision History

Rev.	Release date	Changes	Editor
1.0	20-12-2016	Initial Version	Laszlo Zsedenyi
...			
2.23	06-05-2024	Added audio limitations of the DP outputs	Tamas Forgacs
2.24	27-08-2024	Minor bugfixes	Tamas Forgacs

Contact Us

sales@lightware.com

+36 1 255 3800

support@lightware.com

+36 1 255 3810

Lightware Visual Engineering PLC.

Peterdy 15, Budapest H-1071, Hungary

www.lightware.com

©2024 Lightware Visual Engineering. All rights reserved. All trademarks mentioned are the property of their respective owners. Specifications subject to change without notice.